



INSTITUTE FOR SYSTEMS AND ROBOTICS

Annual Report – 2008



Lisbon Pole



***Torre Norte, Piso 7
IST, Av. Rovisco Pais
1049 – 001 Lisboa
Portugal***

Director

Prof. Victor Alberto Neves Barroso

Vice - Director

Prof. José Alberto Santos-Victor

Torre Norte, 7º Piso

IST, Av. Rovisco Pais

1049 – 001 Lisboa

Portugal

Tel.: + 351 21 841 82 89

Fax.: + 351 21 841 82 91

e-mail: vab@isr.ist.utl.pt

Table of Contents

1	RESEARCH TEAM AND INTERESTS.....	3
1.1	MEMBERS AND COLLABORATORS	3
1.2	CURRENT RESEACH INTERESTS	5
1.2.1	Intelligent Systems	5
1.2.2	Computer and Robot Vision.....	12
1.2.3	Mobile Robotics	15
1.2.4	Signal and Image Processing	16
1.2.5	Evolutionary Systems and Biomedical Engineering	17
1.2.6	Dynamical Systems and Ocean Robotics	21
2	RESEARCH ACTIVITIES	25
2.1	RESEARCH PROJECTS.....	25
2.2	POST-DOCS ACTIVITIES REPORT.....	53
2.2.1	Activity Report of Giampero Salvi	53
2.2.2	Activity Report of Jacinto Nascimento.....	54
2.2.3	Activity Report of Porfírio Silva	55
2.2.4	Activity Report of Vítor Vieira Lopes.....	56
2.2.5	Activity Report of Ruben Martinez-Cantin.....	57
2.3	THESES.....	58
2.3.1	Theses Concluded during 2008	58
2.3.2	Theses in Progress during 2008	77
2.4	ADVANCED TRAINING	90
2.4.1	Courses.....	90
2.4.2	Seminars.....	90
2.4.3	Visits Abroad	93
2.4.4	Reading Groups.....	94
2.4.5	Supervision of Students Enrolled in Foreign Universities	94

2.5	CONGRESS, MEETINGS AND PRESENTATIONS	94
2.5.1	Invited Talks	94
2.5.2	Participations	95
2.6	SERVICE ACTIVITIES	96
2.6.1	Editorial Boards	96
2.6.2	Advisory Boards	96
2.6.3	Programme and Technical Committees.....	96
2.6.4	Chairperson.....	99
2.6.5	Reviewers.....	99
2.6.6	Other Activities	102
2.7	ACADEMIC ACTIVITIES.....	103
2.8	VISITS TO ISR	105
2.8.1	Distinguished Visitors.....	105
2.9	SPECIAL EVENTS	106
2.9.1	“From Human Societies to Artificial Societies”	106
2.9.2	CAS 2008 – Curso de Acústica Submarina 2008.....	106
2.9.3	GREX Trials	107
2.10	Awards	108
2.11	PUBLICATIONS.....	109
3	LABORATORY FACILITIES AND SERVICES.....	127
3.1	Common Facilities	127
3.2	Laboratory Facilities	127

1 RESEARCH TEAM AND INTERESTS

1.1 MEMBERS AND COLLABORATORS

THEORY GROUP

Michael ATHANS, *Principal Researcher*

INTELLIGENT SYSTEMS

Pedro LIMA, *Associate Professor (IST)*

Carlos BISPO, *Assistant Professor (IST)*

Rodrigo VENTURA, *Assistant Professor (IST)*

Matthijs SPAAN, *Doctoral Researcher*

Porfirio SILVA, *Post-Doctoral St., FCT grantee*

Hugo COSTELHA, *Ph.D. St., Lecturer at Instituto Politécnico de Leiria*

Abdolkarim PAHLIANI, *Ph.D. St., FCT grantee*

Bruno LACERDA, *Ph.D. St., FCT grantee*

Gonçalo NETO, *Ph.D. St.*

Aamir AHMAD, *Ph.D. St.*

José N. PEREIRA, *PhD St.*

Marco BARBOSA, *EC FP6 URUS Project grantee*

Sónia CABRITA, *M.Sc. St.*

Alessandra BARBOSA, *M.Sc. St.*

Francisco MENDONÇA, *M.Sc. St.*

Pedro AFONSO, *M.Sc. St.*

Fausto FERREIRA, *M.Sc. St.*

Ana ALEIXO, *M.Sc. St.*

Manuel MALHADO, *M.Sc. St.*

Ricardo ALCÁCER, *M.Sc. St.*

David JERÓNIMO, *M.Sc. St.*

João MESSIAS, *M.Sc. St.*

Artur PREGO, *M.Sc. St.*

Hugo AUGUSTO, *M.Sc. St.*

Nuno RODRIGUES, *M.Sc. St.*

João SANTOS, *M.Sc. St.*

João ESTILITA, *M.Sc. St.*

Carlos NEVES, *M.Sc. St.*

Jorge FERRAZ, *M.Sc. St.*

Henrique MARTINS, *M.Sc. St.*

Dario FIGUEIRA, *M.Sc. St.*

COMPUTER AND ROBOT VISION

José SANTOS-VICTOR, *Associate Professor (IST)*

João Paulo COSTEIRA, *Associate Professor (IST)*

José António GASPAS, *Assistant Professor (IST)*

Alexandre BERNARDINO, *Assistant Professor (IST)*

Luis MONTESANO, *Doctoral Researcher*

Manuel LOPES, *Doctoral Researcher*

Giampiero SALVI, *Post-Doctoral St.*

Ruben MARTINEZ, *Post-Doctoral St.*

Plínio MORENO, *Post-Doctoral St.*

Ricardo BEIRA, *Researcher, Ph.D. St.*

Bruno DAMAS, *Ph.D. St.*

Ricardo FERREIRA, *Ph.D. St.*

Jonas HORNSTEIN, *PhD Student*

Pedro Canotilho RIBEIRO, *Ph.D St.*

Jonas RUESCH, *Ph.D. St.*

Matteo TAIANA, *Ph.D. St.*

Manuel Ricardo MARQUES, *Ph.D. St.*

Giovanni SAPONNARO, *M.Sc. St.*

Verica KRUNIC, *M.Sc. St.*

Nuno CONRARIA, *Engineer*

Ricardo NUNES, *Technician*

Francisco MELO, *External Collaborator*

MOBILE ROBOTICS

Maria Isabel RIBEIRO, *Full Professor (IST)*

João Silva SEQUEIRA, *Assistant Professor (IST)*

Nelson GONÇALVES, *Ph.D. St.*

Alberto VALE, *External Collaborator*

EVOLUTIONARY SYSTEMS AND BIOMEDICAL ENG.

Agostinho da ROSA, *Associate Professor (IST)*

Vitor LOPES, *Post-Doctoral St., FCT grantee*

Carlos FERNANDES, *Ph.D. St., FCT grantee*

Nelson PERDIGÃO, *Ph.D. St., FCT grantee*

Daria MIGOTINA, *Ph.D. St., FCT grantee*

Rogério LARGO, *Ph.D. St., Adjunt Professor EST, IPS*

Gong HONGFEI, *PhD. St., Cornell University, Oxitec UK.*

Cristian MUNTEANU, *Ph.D., Researcher at University of Canarias*

Ernesto SOARES, *Ph.D., Researcher at IMPBN Eberhard-Karls University*

Fernando MELÍCIO, *PhD. Coordinator Professor ISEL, IPL*

Nuno FACHADA, *M.Sc St.*

Paulo SILVA, *M.Sc. St.*

Dulce CALÇADA, *M.Sc. St.*

João BACALHAU, *M.Sc St.*

André ROSADO, *M.Sc. St.*

Vitorino RAMOS, *M.Sc. St.*

Alexandre CALAPEZ, *M.Sc. St.*

Fábio BARATA, *Undergrad. St.*

Carlos ISIDORO, *Undergrad. St.*

Ricardo GRIZONIC, *Undergrad. St.*

André SILVA, *Undergrad. St.*

SIGNAL AND IMAGE PROCESSING

Sérgio JESUS, *Full Professor (UALG)*
Victor BARROSO, *Full Professor (IST)*
Isabel LOURTIE, *Associate Professor (IST)*
Johannes du BUF, *Associate Professor (UALG)*
Jorge S. MARQUES, *Associate Professor (IST)*
Orlando C. RODRÍGUEZ, *Assistant Professor (UALG)*
Pedro M. Q. AGUIAR, *Assistant Professor (IST)*
João SANCHES, *Assistant Professor (IST)*
João Pedro GOMES, *Assistant Professor (IST)*
João XAVIER, *Assistant Professor (IST)*
Margarida SILVEIRA, *Assistant Professor (IST)*
António J. SILVA, *Adjoint Professor (UALG)*
João RODRIGUES, *Adjoint Professor (UALG)*
Marko BEKO, *Adjoint Professor (IPL)*
Paulo FELISBERTO, *Adjoint Professor (UALG)*
Alessio DEL BUE, *Doctoral Researcher (IST)*
Marko STÖŠIĆ, *Doctoral Researcher (IST)*
Cristiano SOARES, *Post-Doctoral St. (UALG)*
Jacinto NASCIMENTO, *Post-Doctoral St. (IST)*
Pedro Mendes JORGE, *Post-Doctoral St. (ISEL)*

Roberto LAM, *Invited Adjoint Professor, Ph.D. St. (UALG)*
Celestino MARTINS, *Research Assistant (UALG)*
Friedrich ZABEL, *Research Assistant (UALG)*
Augusto SANTOS, *Ph.D. St, FCT Grantee (IST)*
Daniel de ALMEIDA, *Ph.D. St. (UALG)*
Dragana BAJOVIC, *Ph.D. St., FCT Grantee (IST)*
Dusan DJAKOVETIC, *Ph.D. St., FCT Grantee (IST)*
Isabel RODRIGUES, *Ph.D. St. (IST)*
João CASTELEIRO, *Ph.D. St. (IST)*
João MOTA, *Ph.D. St., FCT Grantee (IST)*
José RODRIGUES, *Ph.D. St., FCT Grantee (IST)*
José SEABRA, *Ph.D. St, ISR/IST Fellowship (IST)*
Nelson E. MARTINS, *Ph.D. St., FCT Grantee (UALG)*
Nuno NOBRE, *Ph.D. St. (IST)*
Nuno SILVA, *Ph.D. St. (IST)*
Paulo J. SANTOS, *Ph.D. St. (UALG)*
Pinar Oguz EKIM, *Ph.D. St., FCT Grantee (IST)*
Ricardo FERREIRA, *Ph.D. St, FCT Grantee (IST)*
Ricardo RIBEIRO, *Ph.D. St. (IST)*
Rui F. C. GUERREIRO, *Ph.D. St, FCT Grantee (IST)*
Samuel NUNES, *Ph.D. St. (UALG)*

Artem KHMELINSKII, *Undergrad. St. (IST)*
Indira ANDRADE, *Undergrad. St. (IST)*
Pedro GUERREIRO, *Undergrad. St. (IST)*

DYNAMICAL SYSTEMS AND OCEAN ROBOTICS

António AGUIAR, *Invited Assistant Professor (IST)*
Paulo OLIVEIRA, *Assistant Professor (IST)*
António PASCOAL, *Associate Professor (IST)*
Carlos SILVESTRE, *Assistant Professor (IST)*
Naveena CRASTA, *Post-doc Researcher*
Rita CUNHA, *Post-doc Researcher*

Alex ALCOCCER, *Ph.D. St., FCT grantee*
João ALMEIDA, *Ph.D. St., FCT grantee*
Duarte ANTUNES, *Ph.D. St., FCT grantee*
Pedro BAPTISTA, *Ph.D. St., FCT grantee*
Sérgio BRÁS, *Ph.D. St., FCT grantee*
David CABECINHAS, *Ph.D. St., FCT grantee*
Tiago GASPAS, *Ph.D. St., FCT grantee*
Bruno GUERREIRO, *Ph.D. St., FCT grantee*
Vahid HASSANI, *Ph.D. St., FCT grantee*
Anrdeas HAUSLER, *Ph.D St., FREESUNetwork*
Pramod MAURYA, *Ph.D. St., FCT grantee*
Bayat MOHAMMADREZA, *Ph.D. St., FCT grantee*
Marco MORGADO, *Ph.D. St., FCT grantee*
Paulo ROSA, *Ph.D. St., FCT grantee*
Pedro SERRA, *Ph.D. St., FCT grantee*
José VASCONCELOS, *Ph.D. St., FCT grantee*

João BOTELHO, *Research Engineer*
Bruno CARDEIRA, *Research Engineer*
André OLIVEIRA, *Research Engineer*
Manuel RUFINO, *Research Engineer*
Luis SEBASTIÃO, *Research Engineer*

Loic BAMDÉ, *Secretary*

1.2 CURRENT RESEARCH INTERESTS

The Lisbon pole of ISR is internally organized in 6 laboratories/groups. In this section the main research interests of each one of the laboratories/groups are briefly described.

1.2.1 Intelligent Systems

The driving theme of the Intelligent Systems Laboratory is the R&D on decentralized decision-making and control for multi-robot (networked, cooperative) systems (main focus), cognitive robots, human-robot interaction, and management systems. Decentralization is a key issue, as the overwhelming amount of information that must be handled in modern systems, composed of a massive number of embedded sensors, actuators, processors, and wireless communication devices, together with the well-known weaknesses of centralized systems, call for novel approaches to decentralized decision-making at different levels of abstraction, using the “think local, act global” principle. Our research is often driven by practical applications, and the applications include monitoring and decision-making in hazardous/remote environments (e.g., space, contaminated areas, post-disaster scenarios), and services (e.g., ambient assisted living, helping people in public spaces, energy consumption in buildings).

Our distinctive feature is that we bring together people with a common background on systems theory, but different approaches to modeling, analysis and synthesis of intelligent systems, mainly coming from:

- artificial intelligence, with a focus on decentralized and distributed methods, and specific interest in planning under uncertainty, organizational issues, neurosciences-, biology- and social sciences-inspired robot architectures and methods;
- systems and control, with a focus on complex systems consisting of a large number of interconnected embedded systems, e.g., sensor and robot networks, institutional management systems, or biological systems, and specific interest on modeling, analysis and synthesis methods.

In the following, we provide some details on the research and development topics covered by the Lab members in 2008, as well as on the major results achieved.

Discrete Event System Models of Robotic Plans

Thesis: 3 PhD (Hugo Costelha, Gonçalo Neto, Bruno Lacerda), 2 MSc (Artur Prego, Nuno Rodrigues)

Projects: 1 ISR Project (SocRob)

Most of the existing robotic task models are not based on formal approaches, are concerned only with a small number of behaviors and are typically tailored to the task at hand. We have proposed, back to 1998, a systems-theory-based task modeling approach for general robotic tasks which enables a systematic approach to modeling, analysis and design, scaling up to realistic applications, providing methods for logical verification, stochastic performance, and design from specifications, as well as execution improvement over time through learning. Our approach is based on using discrete event systems (DES) models, mainly Petri nets and finite state automata, for robot plans representation. This particular representation enables using all the available DES analysis and design tools to handle robotic task formal analysis and design.

Several lines of research were pursued under this topic:

Robotic task supervision using LTL: Supervisory Control of DES consists of restricting the behavior of a DES in order to achieve a set of specifications, usually expressed as required and/or admissible languages, with respect to the original language of the unsupervised system. In this work, we use Linear-Time Temporal Logic (LTL), an extension of Propositional Logic which allows reasoning over an infinite sequence of states, to specify

the performance objectives for a given DES in a more natural language, and build a supervisor that restricts the DES' behavior to those objectives by construction.

Cooperative plan representation and execution: For Petri net (PN) models of the environment, where transitions are associated to robot controllable events (thus representing its effects), or uncontrollable events (thus representing environment natural events, including those caused by other agents starting their own actions), the key issue is that one can build a large complex robotic task model by connecting simple PN modules which represent the dynamic of the robot subsystems (e.g., the PN representing the navigation system, or the perception system status). Macro-actions can also encapsulate action compositions. Petri net plan representations are especially adequate to represent plans for cooperative robots. In this case, places must also represent communicated messages (sent and received), which in fact represent again predicates which, when their arguments are instantiated, become true or false propositions. Examples: *waiting4you_sent*, *waiting4you_received*, *arriving_sent*, *arriving_received*. Two types of communicated signals are relevant for cooperation (coordination + teamwork): those required for synchronization, and those required for commitment. Synchronization concerns coordination, e.g., two robots transporting a bar and exchanging signals to avoid that one of them advances too much ahead or lags behind.

We have been using PNs to program individual and relational behaviors in the SocRob project with soccer robots, with synchronization and commitment. Commitment is based on the formalism of Cohen's and Levesque's joint commitment theory, and essentially assures teamwork, i.e., once two or more robots get involved in a relational behavior, they mutually commit to inform their involved teammates if the joint goal became irrelevant or can not be reached anymore (e.g., due to a failure of one of them to proceed with its part of the behavior).

Robotic task performance analysis using Petri nets: The whole robot plan, represented by a PN, can be composed with the environment pan, also represented by a PN. Robotic task performance analysis should be performed over the above closed loop model of the robot situated in its environment. Two main classes of analysis problems are: i) qualitative/logical analysis: such as determining PN liveness (is the plan resetable, can the robot recover from an error?), boundedness (are we using too many resources, e.g., calling a primitive action to run concurrently in a number of processors - or robots - larger than those available?), blocking (deadlocks, livelocks); ii) quantitative/stochastic performance analysis: is a plan robust to changes of primitive action reliability around their nominal values? what is the probability of success of a plan, given the reliability of its composing primitive actions?

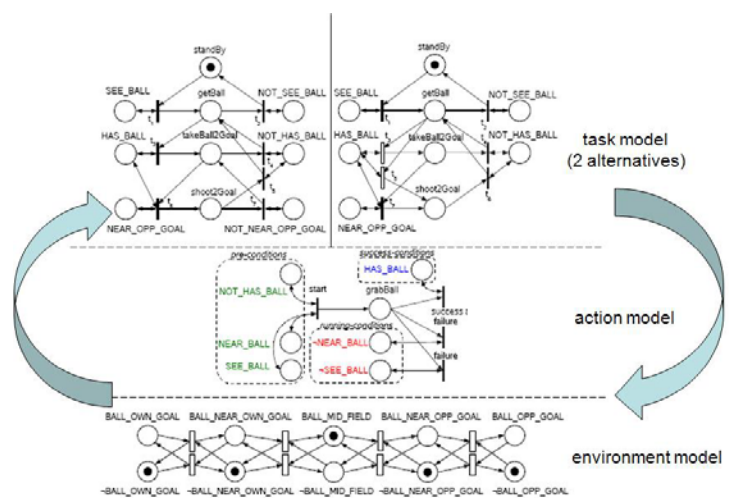

(Decentralized) Planning Under Uncertainty

Thesis: 1 PhD (João Messias), 1 MSc (Hugo Augusto)

Projects: 1 EU Project (URUS), 1 FCT project (Dec-PUCS)

This research concerns computing plans for single agents as well as cooperative multiagent systems, in domains in which an agent is uncertain about the exact consequences of its actions. Furthermore, it is equipped with

imperfect sensors, resulting in noisy sensor readings which provide only limited information. For single agents, such planning problems are naturally framed in the partially observable Markov decision process (POMDP) paradigm. In a POMDP, uncertainty in acting and sensing is captured in probabilistic models, and allows an agent to plan on its belief state, which summarizes all the information the agent has received regarding its environment. For the multi-agent case, we frame our planning problem in the decentralized POMDP (Dec-POMDP) framework. Recent research has been focusing on developing theory, as well as applying such methodologies to sensor and mobile robot networks.

Q-value function for Dec-POMDPs: We published a journal paper which is one of the few that can serve as an introduction to the field. It introduces a Q-value theory for Dec-POMDPs, which have been very useful for planning in single-agent models like MDPs and POMDPs. In this paper we studied define similar Q-value for Dec-POMDPs. Their computation, however, is infeasible for all but the smallest problems. Therefore, we analyzed various approximate Q-value functions that allow for efficient computation. We described a family of algorithms for extracting policies from such Q-value functions, and performed an experimental evaluation on existing test problems, including a new firefighting benchmark problem.

Planning with unreliable communication: In order to scale up the planning algorithms to the types of problems we are interested in, we have to advance the state of the art. One line of research we are interested is to leverage communication between agents, which is a viable solution for multi-robot teams. In particular, we have been considering a model for stochastically delayed communication, which unifies and extends several existing communication models for Dec-POMDPs. In this work, we acknowledged that communication takes time, and that the communication interval can vary. We addressed shortcomings in the current Dec-POMDP literature by explicitly reasoning about the probability of successful communication (with variable delays) in the future. The work provides a significant step towards more realistic communication models for planning in Dec-POMDPs with unreliable communication.

Exploiting locality of interaction: A different theme that we have been pursuing tackles exploiting locality of interaction in decentralized planning under uncertainty. For instance, we have demonstrated how the scalability of optimal planning in Dec-POMDPs can be improved by exploiting locality of interaction between agents in a factored representation. Factored Dec-POMDP representations had been proposed before, but only for Dec-POMDPs whose transition and observation models are fully independent. We considered general factored Dec-POMDPs for which we analyzed the model dependencies over space and time, allowing us to exploit the problem structure as well as heuristics in a single framework.

In a related line of work, we considered a different model, in which agents are assumed to have their own task, and interaction among them is again a local phenomenon. It combines several fundamental properties from transition-independent Dec-MDPs and weakly coupled MDPs while allowing to address, in several aspects, more general problems. Our intuition here is that many multi-robot planning problems, such as robots delivering packages in an office building, can be successfully captured and solved using such a model. We introduced a fast approximate planning method, exploiting the model's particular structure, and we illustrated its successful application on several large multiagent tasks.

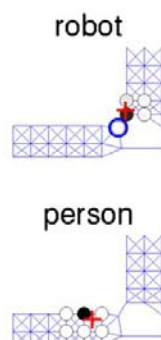

Planning under uncertainty for sensor networks: We have been applying planning-under-uncertainty methodology such as POMDPs to networks of (visual) sensors and robots. Given the large resource demands of imaging sensors in terms of bandwidth and computing power, processing the video streams of a large number of cameras simultaneously might not be feasible. Given these resource constraints and a set of sensors, we study the problem of selecting a subset

of sensors that can be active at any point in time. The goal of the system is to optimize a user-defined objective. We consider several possible objectives, for instance maximizing coverage or minimizing uncertainty when tracking people. We focus on developing dynamic sensor selection methods, which can change the active subset of sensors over time. In this way, the system can react to the observed state of its environment, significantly improving the system's performance. We model the problem of tracking a person using n cameras as a POMDP, under the constraint that only k cameras can emit observations at any point in time. This resource constraint forms a general way to model restrictions in available bandwidth or computing power. We show how, by changing the POMDP's reward function, we can change the system's behavior in a straightforward manner, fulfilling the user's chosen objective. We have demonstrated our techniques on the ISRobotNet network of 10 cameras, illustrating the rich set of behaviors we can achieve.

Cooperative Perception and State Estimation

Thesis: 2 PhD (Sónia Marques, Abdolkarim Pahlani), 1 MSc (João Santos)

Projects: 1 EC Project (URUS), 1 FCT (Dec-PUCS), 1 ESA project (already concluded)

A robots team may cooperate in several forms. One of them concerns the common observation of (possibly moving) objects by the team, so as to reduce the uncertainty of the estimate of the object location and velocity by information fusion. One particular case occurs when the observed object is another element of the team. In this case, one refers to cooperative navigation. These two lines of research have been developed in this period.

Active Cooperative Perception: Cooperative perception refers to the fusion of sensory information between fixed surveillance cameras and robots, with as goal maximizing the amount and quality of perceptual information available to the system. This information can be used by a robot to choose its actions, as well as providing a global picture for monitoring the system. In general, incorporating information from spatially distributed sensors will raise the level of situational awareness. Active perception means that an agent considers the effects of its actions on its sensors, and in particular it tries to improve their performance. This can mean selecting sensory actions, for instance pointing a pan-and-tilt camera or choosing to execute an expensive vision algorithm; or to influence a robot's path planning, e.g., given two routes to get to a desired location, take the more informative one. Performance can be measured by trading off the costs of executing actions with how much we improve the quality of the information available to the system, and should be derived from the system's task. Combining the two concepts, cooperative active perception is the problem of active perception involving multiple sensors and multiple cooperating decision makers.

In general, we consider decision-theoretic approaches to cooperative active perception. We propose to use Partially Observable Markov Decision Processes (POMDPs) as a framework for active cooperative perception. POMDPs provide an elegant way to model the interaction of an active sensor with its environment. Based on prior knowledge of the sensor's model and the environment dynamics, we can compute policies that tell the active sensor how to act, based on the observations it receives. As we are essentially dealing with multiple decision makers, it could also be beneficial to consider modeling (a subset of) sensors as a decentralized POMDP (Dec-POMDP). In a cooperative perception framework, an important task encoded by the (Dec)POMDP could be to reduce the uncertainty in its view of the environment as much as possible. Entropy can be used as a suitable measure for uncertainty. However, using a POMDP solution, we can tackle more elaborate scenarios, for instance in which we prioritize the tracking of certain objects. In particular, POMDPs inherently trade off task completion and information gathering.

Cooperative navigation: A general formulation that can be applied to the decentralized estimation of the 6 Degrees of Freedom (DoF) translational and rotational components of the full-order state vector of a N -vehicle

formation was developed. Graph theory was applied to model the measurements and the information flow within the formation, to analyze the impact of a connection breakdown (a vehicle failure, for example) on the performance of the navigation algorithm, and to establish requirements for the algorithm to be robust to changes in the topology of the measurement graph and the information flow graph. From the navigation standpoint, a vehicle formation endowed with distance sensors and RF communications can be considered to have two underlying networks: a communication network, where networked vehicles communicate state estimates, and a measurement network, linking each vehicle to the vehicle(s) it measures the relative distances to. In general, a vehicle measures distances and communicates them to any of its teammates. Nevertheless, it is desirable to reduce the number of measurements and especially the number of links in the communication network.

The concept proposed in this work is to have each vehicle measuring locally the distance to another vehicle (as expressed in the team measurement network), and transmitting its updated state estimates to another vehicle (as expressed in the team communications network). The measurement network concerns the distance measurements to another vehicle. The communication network concerns the communication between pairs of vehicles, in order to transmit the full state estimate between them. The state estimates are considered as observations in the receiving vehicle.

The navigation algorithm is based, at each vehicle, on an Extended Kalman Filter (EKF) for local measurements, and on a Covariance Intersection (CI) algorithm (plus the EKF prediction part) for the measurements communicated by its networked vehicles in the communications network. The CI algorithm avoids the possible divergence of the EKF at the receiving vehicle, due to correlation between measurements of the vehicles in the team, by computing an upper bound for the covariance matrix of the fused variables. The price to pay is reduced estimation accuracy. Therefore, in the filtering step, the EKF is used when observations are measurements from the sensors, and the CI algorithm is applied whenever the observations are the state vector estimates sent by a vehicle linked by the communications network.

The developed algorithms were applied to the realistic simulation of a 3-spacecraft system that emulates the European Space Agency (ESA) Darwin mission. Results of experiments with and without the estimator in the Guidance and Control loop are presented.

Human-Robot Interaction

1 PostDoc involved (Porfírio Silva)

Thesis: 2 PhD (Valdinei Silva, José N. Pereira), 5 MSc (Ana Aleixo, Manuel Malhado, Jorge Ferraz, Henrique Martins, Fausto Ferreira)

Projects: 2 ISR Projects (Institutional Robotics, Search and Rescue Robots)

Several distinct lines of research have been pursued under this topic.

Agent programming by preference elicitation under evaluations over observed behaviours: the use of preference elicitation in computational systems helps to improve the delegation of task execution to computer agents, enabling lay people to program easily a computer agent with their own preference. The preference of a person (user) is elicited through his answers to specific questions, that the agent formulates by itself. The structure and context of the questions have been pointed as sources of variance regarding the user's answers, and such variance can jeopardize the feasibility of preference elicitation. In Valdinei Silva's PhD thesis we attempt to avoid such variance by asking a user to choose between two behaviours that were observed by himself. Evaluating relatively observed behaviours turn questions more transparent and simpler for the user, decreasing the variance effect, but it might not be easier interpreting such evaluations. If

divergences between agent's and user's perceptions occur, the agent may not be able to learn the user's preference. Evaluations are generated regarding user's perception, but all an agent can do is to relate such evaluation to his own perception. Another issue is that questions, which are exposed to the user through behaviours, are now constrained by the environment dynamics and a behaviour cannot be chosen arbitrarily, but the behaviour must be feasible and a policy must be executed in order to achieve that behaviour. Whereas the first issue influences the inference regarding user's evaluation, the second problem influences how fast and accurate the learning process can be made. The thesis proposes the problem of preference elicitation under evaluations over observed behaviours using the Markov Decision Process framework and theoretical properties of such framework are developed in order to turn the problem computationally feasible. The problem of different perceptions is analysed and constraint solutions are developed. The problem of demonstrating a behaviour is considered under the formulation of questions based on stationary policies and non-stationary policies. Both types of questions were implemented and tested to solve the preference elicitation in a scenario with constraint conditions.

Institutional Robotics is a new strategy to conceptualize multi-robot systems, which takes institutions as the main tool of social life of robots with bounded rationality and bounded autonomy. This institutional approach intends to get inspiration from philosophical and social sciences research on social and collective phenomena, and is mainly inspired by concepts from Institutional Economics, an alternative to mainstream neoclassical economic theory. The goal is to have multiple robots developing activities in a shared environment with human, in such a way that humans can interact with robots "naturally", intuitively, without a need to learn specific techniques to deal with them. The focus is not one-to-one interaction, but social behaviour in physical and social environments populated with many natural as well as artificial agents. So, the robots must be able to recognize institutions and institutional indicators that humans also recognize as structuring forms of their complex social relationships. This includes, for instance, rules, routines, signs, forms of organization of the material world, social roles, and social forms as organizations or teams.



Adjustable Autonomy: research on adjustable autonomy for robot remote operation was carried out using the RAPOSA platform, a tracked wheel robot built in cooperation with the Portuguese company IDMind (an ISR spinoff), together with the Lisbon firefighters corporation, namely in the following topics:

- autonomous docking to the robot cable providing power and a wireless link access point;
- autonomous stair climbing;
- 3D remote operation using a Head Mounted Display and the robot camera pairs to feed stereo video, thus providing the operator with depth perception of the environment surrounding the robot.

Cognitive architectures

Thesis: 2 MSc (Dario Figueira, Carlos Neves)

Projects: 1 EU Project (RobotCub)

In the engineering of machine intelligence one cannot disregard natural intelligence that humans, together with other animals, display. Intelligence is here understood in the broad sense of behaving appropriately situated in an environment, as in the case of a fight-or-flight response for securing survival, as well as in the case of a mathematician proving a theorem. In these situations, hard to cast as a neat optimization problem,

scientists often look into biology for inspiration. What biological evolution solved before has the potential for, at very least, provide guidance on how to approach the problem. Interest on cognitive architectures had its origin on previous research carried out by the group on emotion-based agent models. Neuroscientific findings on the role of emotion mechanisms in the brain to decision-making processes have driven this research towards the construction and experimental testing of agent models taking those aspects into account.

Research in this area is focused on i) decision-making, namely in the interplay between emotion mechanisms and rationality, and on ii) robotic platforms (e.g., humanoid robots) situated in a physical environment, socially interacting with humans, other robots, and objects in the environment.

As ISR is one of the partners of the RobotCub EU project, research has been conducted using the humanoid robot being developed in this project: the iCub. ISLab has been working on endowing iCub's cognitive architecture with a spatial model of the environment. This model is built on top a basic attention system, driven by perceptual features. At the current stage of this research, the iCub is capable of learning new objects, once they are shown to it close to his "eyes". Whenever learnt objects are found on the environment, iCub gazes at them, sequentially.

Field Robotics

Thesis: 2 MSc (Ricardo Alcácer, David Jerónimo)

Projects: 1 ISR Project (Search and Rescue Robots)

Aerial robots are capable of providing invaluable contribution for a cooperative team of robots, first because they can carry cameras and thus sending video stream captured from an altitude position, but also because they may be capable of mapping the terrain. These maps can then be used by land vehicles for navigation.

Research using a particular kind of aerial robot - a blimp - was carried out in this period, namely on:

- Providing the aerial 4m-long blimp robot with full indoors operation autonomy (from a technological standpoint), by endowing it with onboard computational power (based on a DSP), a video-camera, a video transmitter, NiCad batteries and a GPS device. All these but the GPS installation have been successfully accomplished so far. The DSP includes a video acquisition board and supports image processing plus guidance and control code. Connection to a GPS device is also possible, but not yet implemented. The onboard video transmitter is used to provide real-time image processing feedback (e.g., useful for debugging purposes) to the ground operator, who can also gain remote manual control of the robot whenever found appropriate;
- Realistically simulating the aerial blimp and land ATRV-Jr robots, based on USARSim, such that developed code can be tested on the simulator and then switched to the actual blimp hardware without needing any extra modifications. Actually, control of the actual hardware and of the simulated blimp model can also be carried out simultaneously, if so desired;
- Developing and testing vision-based algorithms for ground-lines following and object tracking (e.g., the ATRV-JR land robot) by the aerial blimp robot.



Health Care Management

Thesis: 2 MSc (Alessandra Barbosa, Sónia Cabrita)

Projects: 1 Health Ministry Project (Concepção, Planeamento e Controlo de Processos Operacionais em Unidades de Saúde Familiar)

Partially funded by the Health Ministry and ISR, the work conducted aims at identifying interesting research topics in Health Care Management. The first project, which is ongoing and started in the beginning of 2008, intends to model Family Health Clinics.

During the last four years, in the context of the Portuguese National Health Service, there has been a significant change in the way Primary Care is provided. Aside the usual Public Health Centers (PHC), a new structure is being put in place, denominated as Family Health Units (FHU). Each FHU is composed by a maximum of 10 doctors, 10 nurses, and 7 administrative assistants, where each family enrolled in a given unit is usually assigned to a specific doctor and nurse. A FHU possesses a higher degree of autonomy and incentives than the older PHC. The standard hours of operation of a FHU are from 8:00 AM to 8:00 PM, ensuring that there is always, at least, one doctor available and trying to ensure also that any user in need of an urgent consultation will be seen by some doctor, even if it is not his/her family doctor, as the FHU may choose to provide doctor substitution for some types of appointments.

One of the challenges faced by these FHU, consists in (1) deciding the variety of services to provide and how many hours to allocate to each one of them, as well as what is the allocated duration for each service. By variety of services, or typologies, we mean, taking doctors' appointments as an example, Diabetes, Women's Health, Children's Health, House Visits, General Adult and Family, Same Day Consultation, etc. This decision also entails deciding if the doctors' agenda is free for any typology, or if each single typology is to be offered in pre-defined blocks of time, or something in between these two extremes.

Once the variety and total hours per type have been decided, the next problem that needs to be addressed is (2) what type of regulation mechanisms to implement for the access of the users to the offered services. That is, do they have to schedule an appointment in advance or can they just walk in? If they have to schedule, how far ahead are they allowed to do it? Should the access policy be different when the scheduling initiative is taken by a professional (doctor/nurse) or by a user?

We call the combination of these two problems the Offer Dimensioning Problem (ODP).

In order to help these teams to evaluate their decisions concerning this problem we developed a simulator, using iGrafx™, where different agendas for each doctor may be defined, as well as different access policies. Once that is done, demand for doctors' appointments is generated, with parameters estimated from the FHU's database, containing an historic of all appointments for some time period, and a series of statistics is produced and collected. These will then provide a basis to support changes in the dimensioning of the agendas and in the access policies.

1.2.2 Computer and Robot Vision

Vision is an extremely powerful sensing modality that allows many living beings to perceive the surrounding world and act accordingly. It provides information with a large spatial resolution and reasonable temporal dynamics, while allowing the measurement of multiple types of properties of the visual world: color, texture, motion, shape, contrast, etc.

Computer vision and image analysis can thus enable a large number of applications, like 3D reconstruction, motion analysis, video surveillance and robotics, to name just a few. In addition, the massive deployment and cost reduction of cameras and the availability of low-cost, powerful processors have contributed to an increasing number of application opportunities.

The research conducted at the Computer and Robot Vision Lab - Vislab has two main goals: (i) the development of new methodologies and tools for computer and robot vision and (ii) demonstrate such methodologies in challenging applications that call for such new tools. The research is organized in two main lines:

- **Vision Based Control and Navigation**
- **3D Reconstruction, Motion Analysis and Surveillance**

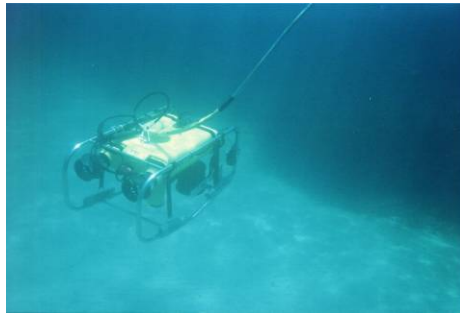
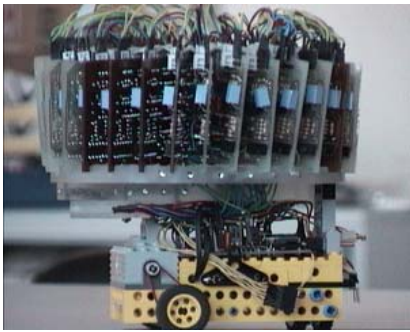

a) Vision Based Control and Navigation

In this topic, we address the fundamental problem of understanding what *relevant* information can be extracted from an image sequence to *control* an artificial system (robot) in order to perform a *given task*. This line of research has been pursued for a long time in the VisLab, often with an emphasis on bio-inspired approaches. The biological inspiration is not only aimed at designing more flexible and robust artificial vision systems but also to help understanding biological systems through the process of modeling. The following research topics are currently being pursued:

Visual Geometries: Natural vision systems have different geometries (e.g. compound versus corneal eyes). One of the research lines consists in designing non-conventional cameras (e.g. omnidirectional cameras, space-variant sensors) that may be more suitable for a class of visual tasks.

Vision based control, Active vision and navigation: the active control of the visual sensors may ultimately constrain and simplify the recovery of visual information. The design of vision-based control systems has been tackled for a long time covering many types of robotic systems: mobile (land, air and underwater) vehicles, robotic heads, etc. We also exploit biological plausible representations of the environment that contribute to efficient navigation strategies.

Learning and cognition: this line of research has evolved towards cognitive systems, with the ability to learn in an open-ended way from long periods of observation. One example lies in the area of human activity recognition from video as in e.g., video surveillance. Another example is the study of techniques allowing a complex system to develop and adapt over long periods of time as in e.g. humanoid robots. We have focused considerable research efforts on developing methodologies for humanoid robots to learn how to perform complex tasks through observation. This work has been undertaken in a tight collaboration with neuroscientists and developmental psychologists.



b) 3D Reconstruction, Motion Analysis and surveillance

The goal 3D motion analysis and reconstruction is to retrieve information about the scene structure (geometry) or camera motion from video sequences. Work has addressed the problem of estimating the 3D motion of a camera from an image sequence. Several visual cues were exploited for this purpose: the visual motion and occlusions. Regarding 3D reconstruction, work has focused on developing optimal approaches for matching image features, which is a fundamental step in most 3D vision systems. In addition, the depth estimation process has been formulated in an optimal way by itself.

By imposing physical constraints such as rigidity, the reconstruction process was reformulated such that it can cope both with partial views of the object and degenerate surfaces (such as planar or piecewise planar objects). This new view of the problem lead to a innovative algorithm with quite diverse applications:

1 – Reconstruction of an object with quite diverse images (different scale, partial views)

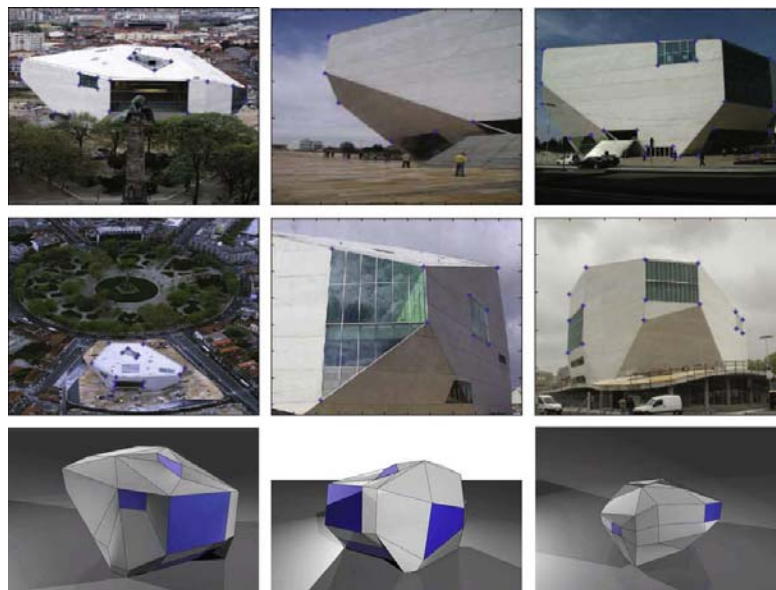

2 – A new biometric algorithm which identifies people by measuring the compliance of an acquired image of a face with a rigid transformation of a known model. Due to the above characteristics (missing data and robust to degeneracies) the biometric systems is able to handle strong face pose.

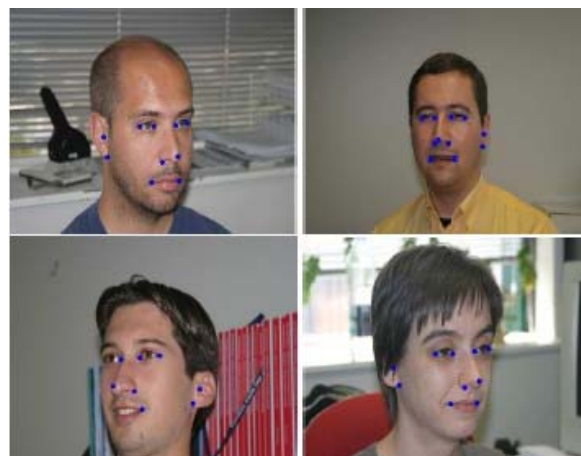

Another line of research is focused on the development of video surveillance systems able to understand human activities. The increasing number of cameras deployed in public spaces, makes it impossible for human operators to continuously monitor an overwhelming number of visual streams. We need systems able to interpret the human behavior in video imagery and call for the security operator attention only when an alarming event is observed. Further we apply similar approaches for human-robot interaction whereby non-verbal (gesture) communication can be a rich source of information.



Research in all these topics has been carried out both at the level of the fundamental methodologies and also for applications. As the knowledge in these various aspects matures inside the group, research projects have been proposed, including national and European Projects.

1.2.3 Mobile Robotics

The objective is to undertake research in the area of mobile robotics, with emphasis on the navigation of single and multi-robot systems and human-robot interaction. Our research is often driven by the applications, and combines theoretical and implementation issues with the design and assembly of real robots.

The navigation of mobile robots is addressed in structured and unstructured environments. Surveillance and transport applications provide the context and motivation in both single and multiple robot scenarios. These are problems requiring the integration of multiple techniques, ranging from path planning and trajectory following, environment localization and mapping to high level supervision and decision making and architectures to integrate different components. Standard EKF techniques are used to localization and mapping. Robot control is addressed using inclusion systems to model behaviors. High level supervision is supported on market based systems.

Human-Robot Interaction is the external layer that encapsulates all other subsystems in a robot. It is likely that using human-based models, with formal descriptions of concepts that have been intensively studied in social sciences, will foster the development of social robots. The focus of our research is the mathematical modeling of concepts that can model human interactions and their extension to the modeling of human-robot and robot-robot interactions. Semantics is extensively used by humans and provides a typical example of such key concepts as it contains the mechanism for robots to engage socially with non-expert humans. Hybrid systems and nonsmooth calculus provide the main tools for modeling and analysis.

Applications include the development of a prototype robot capable of moving over power lines on inspection/monitoring tasks, and material transportation in ITER.

1.2.4 Signal and Image Processing

The research of SIPG at IST is organized along four areas: a horizontal area that deals with fundamental problems of signal and image processing and three other areas that build the path to more application-driven research (Sensor Networks, Image and Video Analysis, and Biomedical Engineering), where results emerging from the area of Fundamentals may be applied.

Fundamentals

Research on fundamental theoretical problems will be pursued along two main lines:

- Signal processing on manifolds: key to many emergent applications involving curved spaces. We plan to complete our preliminary work in three topics: performance bounds for estimators, principal component analysis, and statistical models on manifolds;
- Nonconvex optimization: important applications in signal and image processing require solving nonconvex optimization problems, e.g., analysis of video sequences with missing data. We plan to solve certain classes of nonconvex problems by explicitly constructing the convex hull of their epigraph. Important instances that arise in video analysis are quadratic problems over the Stiefel manifold.

Sensor Networks

The advent of small processors with sensing/communication capabilities have spurred the interest into sensor networks for monitoring critical infrastructures. In these large-scale systems, the information between sensors and actuators is supported by a communication network with hard bandwidth constraints. We plan to develop novel algorithms for distributed detection and nonlinear parametric estimation, robust to quantization and random link failures. This research is also the focus of the CMU-PT program in which ISR participates.

Image and Video Analysis

Research on image and video analysis will continue to be motivated by fundamental limitations of current methods. In what respects to 3D video analysis, we plan to overcome limitations like the need to compute pointwise correspondences between different views, and the lack of robustness with respect to partial occlusion. Other fundamental problems in image analysis concern the recognition of objects from their shape. We plan to address fundamental issues like shape representation and recognition. In what respects to human activity recognition for surveillance applications, we plan to develop new representations for human motion and activity recognition trying to overcome the limitations of current ones.

Biomedical Engineering

Current activities in medical image analysis using ultrasound and MRI images will continue.

Three new directions will be followed at three distinct levels:

- Brain and nervous system: diagnosis of Alzheimer's disease and mild cognitive impairment using PET images; identification of sleep disorders and development of models for the autonomic nervous system using control theory.
- Cell analysis: cell analysis based on confocal microscopy in collaboration with Institute of Molecular Medicine.
- Genomic signal processing: ISR is committed to expanding this area of research. Work is already being conducted on problems of DNA sequencing and spectral analysis.

SiPLAB is a research group with its own computer facilities and underwater acoustic equipment, hosted at the University of Algarve, which is a part of the Signal and Image Processing Laboratory of ISR. SiPLAB consists of a group of University professors, researchers and students interested in signal processing, underwater acoustics and communications. It currently hosts 3 professors, several research scientists, Ph.D. students, postdocs, 2 system engineers and various undergraduate students.

Current interests of the PS-Algarve group are focused on various signal processing techniques for ocean acoustic applications such as geoacoustic and water column inverse problems, Bayesian data assimilation techniques and sonar source localization and tracking. An area of particular growing interest is environmental based channel equalization for underwater acoustic communications and its application to high throughput asymmetric data transmission between single transducer nodes and multiple sensors (array) base stations. Applications to establishing new concepts for underwater networks are also been explored.

1.2.5 Evolutionary Systems and Biomedical Engineering

The research work of this group focus on biologically inspired new algorithms and paradigms for search and optimization. Current focus is on Evolutionary Algorithms for Dynamic Environments and Artificial Life Modelling and Simulations of Bio-systems.

Biomedical signal and imaging processing algorithms and applications have been a sustained interest of the past few years. The potential of the results have been demonstrated in applications. A few recent results will be presented below:

Evolutionary Algorithms with Dissortative Mating in Static and Dynamic Environments

Individuals' selection strategies in Evolutionary Algorithms (EAs) mimic the process of natural selection in species. Whatever the method chosen, chromosomes codifying good solutions must be chosen more often for recombination events. Traditional EAs usually engage in *random mating* strategies, that is, mating chance is independent of genotypic or phenotypic distance between individuals. However, random mating is not the sole mechanism of sexual reproduction observed in nature. *Non-random mating*, which encloses different kinds of strategies based on parenthood or likeness of the agents involved in the reproduction game, is frequently found in natural species, and it is believed to be predominant among vertebrates. *Dissortative mating* —, which is a specific type of non-random mating, may improve EAs performance by maintaining the genetic diversity of the population at a higher level during the search process. In this chapter, we propose a study on EAs with Dissortative Mating strategies and their application to static and dynamic problems. Dissortative Mating will be discussed within a biological framework and some Artificial Life models will be analyzed; a detailed description of several methods found in EAs literature will be also given. A special emphasis will be put on the Variable Dissortative Mating GA (VDMGA), holds a mechanism that varies GA's mating restrictions during the run, by means of simple rule based on the number of chromosomes created in each generation and indirectly influenced by the genetic diversity of the population. The empirical study shows that VDMGA performs well when applied to a wide range of problems: it consistently outperforms traditional GAs and positive assortative mating GAs, and it is more robust and fast than some previously proposed Dissortative Mating GAs. The tests and results suggest that VDMGA's ability to escape local optima and converge more often to the global solution may come from maintaining the genetic diversity at a higher level when compared with traditional GAs. VDMGA's genetic diversity naturally leads the research towards the application of the algorithm on Dynamic Optimization Problems (DOPs). In addition, by keeping some individuals in the population for more than one generation (VDMGA is steady-state algorithm, that is, a population may hold both parents and offspring), the algorithm holds a simple and explicit memory mechanism. Due to their specific characteristics, DOPs require additional tools, many of them different from those widely studied by EAs researchers on static problems. Memory schemes and niching are some of the techniques used to tackle DOPs. Strategies for maintaining genetic diversity and/or introducing novelty in the EAs populations are also very efficient strategies when solving dynamic problems. In this proposal, the original VDMGA is subject to minor modifications, and then applied to DOPs benchmarks and compared to other GAs. The results confirm the predictions and show that VDMGA strongly improves other GAs' performance on DOPS. Dissortative Mating, via a simple and easily tunable algorithm (VDMGA), reveals interesting skills when evolving in dynamic environments.

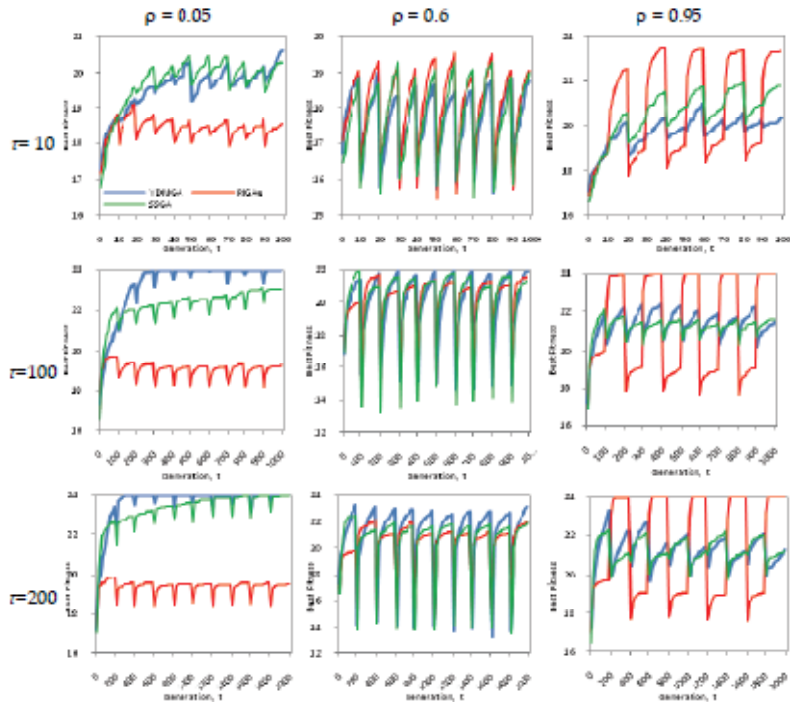

Fig. 4. Dynamics when tracking 4-trap functions ($L = 24$). *Best_of_generation* curves.

(Fernandes & Rosa, 2001; Fernandes, 2002) show that the variation of diversity in GAs populations is influenced by the chosen mating strategy. In (Fernandes & Rosa, 2008), a study on genetic diversity also confirmed this assumption. To measure diversity, the following equation was used:

$$d(P) = \frac{\sum_{i=1}^L \min(F_i, 1 - F_i)}{L / 2} \quad (9)$$

Enhancing Obstetric and gynecology ultrasound images by adaptation of the speckle reducing anisotropic diffusion filter

So far there is no ideal speckle reduction filtering technique that is capable of enhancing and reducing the level of noise in medical ultrasound (US) images, while efficiently responding to medical experts' validation criteria which quite often include a subjective component. This paper presents an interactive tool called evolutionary speckle reducing anisotropic diffusion filter (EVOSRAD) that performs adaptive speckle filtering on ultrasound B-mode still images. The medical expert runs the algorithm interactively, having a permanent control over the output, and guiding the filtering process towards obtaining enhanced images that agree to his/ her subjective quality criteria.

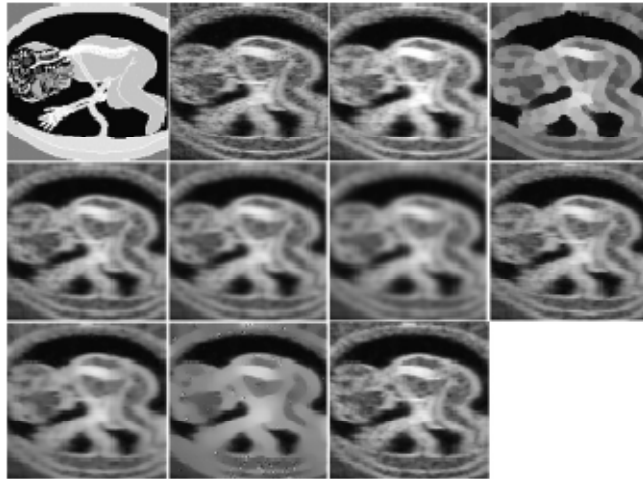

Figure 9 Results for the synthetic image; from left to right, top to bottom: foetus phantom ("Ideal" image); corrected and registered synthetic US image; US simulated image filtered with: EVOSRAD; offset, ANDIFF ($f_{max} = 3$), ANDIFF ($f_{max} = 5$), ANDIFF ($f_{max} = 10$), SRAD ($f_{max} = 3$), SRAD ($f_{max} = 5$), SRAD ($f_{max} = 10$), and median filter.

Simulating Antigenic Drift and Shift in Influenza A

Computational models of the immune system and pathogenic agents have several applications, such as theory testing and validation, or as a complement to rst stages of drug trials. One possible application is the prediction of the lethality of new Infenza A strains, which are constantly created due to antigenic drift and shift. Here, we present an agent-based model of immune-influenza A dynamics, with focus on low level molecular antigen-antibody interactions, in order to study antigenic drift and shift events, and analyze the virulence of emergent strains. At this stage of the investigation, results are presented and discussed from a qualitative point of view against recent and generally recognized immunology and influenza literature.

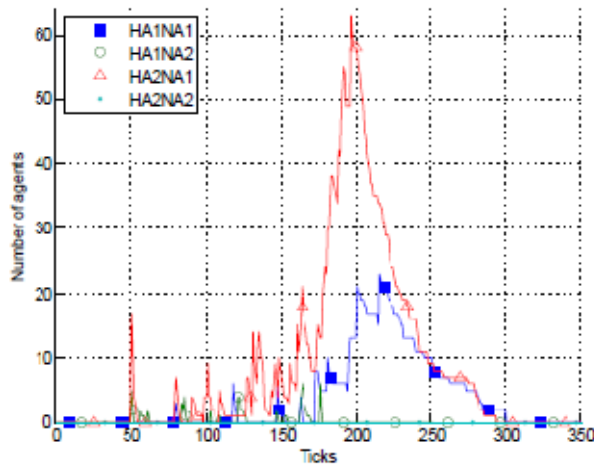

Figure 10: Evolution of Influenza A subtypes during antigenic shift simulation.

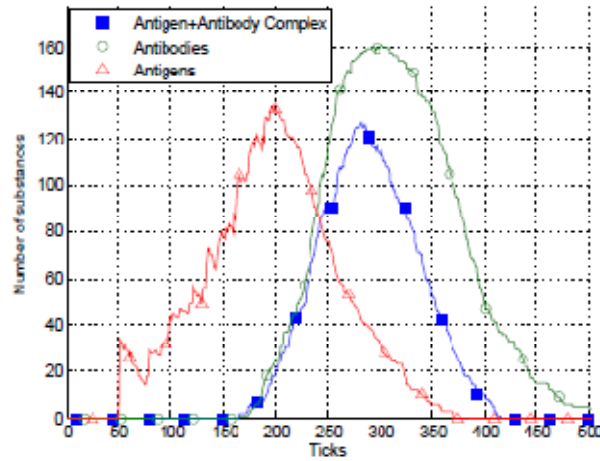
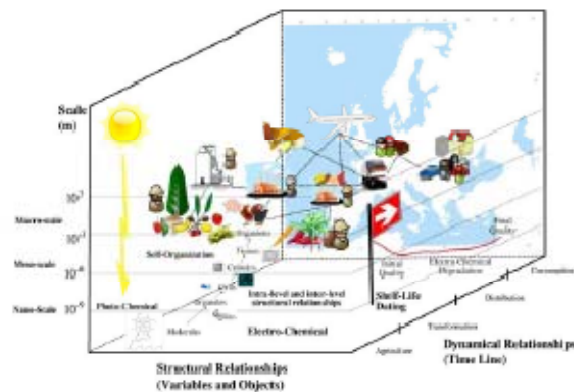

Figure 12: Substance family diversity during anti-genic shift simulation.

Computational Shelf-Life Dating: Complex Systems Approaches to Food Quality and Safety

Shelf-life is defined as the time that a product is acceptable and meets the consumers expectations regarding food quality. It is the result of the conjunction of all services in production, distribution, and consumption. Shelf-life dating is one of the most difficult tasks in food engineering. Market pressure has led to the implementation of shelf-life by sensory analyses, which may not reflect the full quality spectra. Moreover, traditional methods for shelf-life dating and small-scale distribution chain tests cannot reproduce in a laboratory the real conditions of storage, distribution, and consumption on food quality. Today, food engineers are facing the challenges to monitor, diagnose, and control the quality and safety of food products. The advent of nanotechnology, multivariate sensors, information systems, and complex systems will revolutionize the way we manage, distribute, and consume foods. The informed consumer demands foods, under the legal standards, at low cost, high standards of nutritional, sensory, and health benefits. To accommodate the new paradigms, we herein present a critical review of shelflife dating approaches with special emphasis in computational systems and future trends on complex systems.

Fig. 3 Food quality and safety as a CS: multi-scaled structure and dynamical relationships



1.2.6 Dynamical Systems and Ocean Robotics

Objectives

One of the key objectives of the DSORL is to meet some of the challenges in advanced robotic vehicle systems design and control contributing to the development of faster, cheaper, and far more efficient methods for ocean exploration and exploitation. This has motivated the definition of a research and development program addressing theoretical and practical engineering issues, as well as issues related to the interplay between marine sciences and marine technology. Two main lines of action were set:

1. Contributing to furthering the knowledge in the general area of dynamical system theory.
2. Developing new analysis and design tools in the areas of navigation, guidance, and control (NGC) and applying them to the development of advanced systems enabling the operation of multiple networked autonomous marine and aerial vehicles.

Theoretical Objectives:

- A. Linear and nonlinear systems theory: study and development of theoretical tools for the analysis and design of linear and nonlinear control / filtering systems.
- B. Robust Multiple Model Adaptive Control (RMMAC): Development of new methodologies for the design of robust adaptive controllers for plants with structured and unstructured uncertainty.
- C. Design of Navigation Systems for autonomous vehicles. Study of advanced solutions focusing on the: i) development of highly performing, moderate cost heading and attitude reference units; ii) study and practical evaluation of acoustics-based systems for underwater vehicle positioning; iii) development of geophysical-based navigation algorithms.
- D. Motion Control of single and multiple vehicles under stringent communication constraints, including those imposed by a very special medium: the ocean. Problems addressed: i) Motion control of autonomous vehicles; ii) Visual servoing control; iii) Path Following; iv) Terrain Contour Tracking; v) Coordinated/cooperative control of groups of autonomous vehicles; vi) Networked control over faulty communication links.

Practical Objectives:

- A. Design and development of AUVs, ASCs and UAVs and on-board integration of scientific sensor suites and data acquisition / logging systems.
- B. Distributed hardware and software architectures for coordinated navigation and motion control of multiple vehicles as well as mission control
- C. Tests and scientific missions with the robots developed in cooperation with the scientific partners of the ISR Associated Laboratory and other international institutions.

Main Achievements

Theoretical achievements

1. Advances on the formulation of a Robust Multiple-Model Adaptive Control (RMMAC) architecture for linear time-invariant and time-varying systems subjected to structured and unstructured uncertainty. New theoretical results were obtained on Identification and Convergence Analysis of a Class of Continuous-Time Multiple-Model Adaptive Estimators.
2. Study of linear and nonlinear control algorithms for motion control of fully and underactuated autonomous robotic vehicles in threedimensional space, including control algorithms for terrain avoidance and rotorcraft landing. New results on performance limitations in reference tracking and path-following for nonlinear systems.
3. Design of a novel family of nonlinear kinematic observer for pose estimation in SE(3). An almost globally exponentially stable attitude and position observer was obtained.
4. Further development and experimental evaluation, using the Catamaran DELFIMx, of a low cost Inertial navigation System (INS) based on asymptotically stable discrete-time nonlinear complementary filters that merge inertial measurements with Earth's magnetic field observations and GPS data.
5. Study of filtering structures for USBL tightly-coupled inertial navigation. Development of nonlinear GPS/IMU based observers for rigid body attitude and position estimation. Study of estimators on SE(3) using range-only measurements Development and practical evaluation of acoustics-based systems for underwater vehicle positioning and tracking. Estimation algorithms were derived and their performance tested during real missions at sea.
6. Study and assessment in simulation of algorithms aimed at steering fleets of mobile robots along a set of given spatial paths, while keeping a desired inter-vehicle formation pattern. Decentralized algorithms that explicitly address the dynamics of the cooperating vehicles and the constraints imposed by the nature of the inter-vehicle time-varying communications network were derived. Study of algorithms for multiple vehicle path planning ensuring spatial or temporal deconfliction (non-collision).
7. Study of feature based navigation algorithms for the execution of long range missions with marine vehicles in unstructured environments. Integrated navigation solutions based on bathymetric and geomagnetic data were derived.

Practical Achievements

1. Full system development, implementation, and demonstration of the operational capabilities of the DELFIMx robotic ocean vehicle and a prototype Autonomous Helicopter.
2. Demonstration of coordinated vehicle motion control with the DELFIMx and a manned vessel at sea in the Azores, in cooperation with the MAR/DOP/Univ. Azores and the partners of the EU GREX project. This entailed the implementation of algorithms for cooperative control and full development of a middleware architecture for mission planning and mission control.

3. Acoustic and navigation system integration, followed by the execution of high resolution multibeam surveys in cooperation with the IMAR/DOP/Univ. Azores. The system developed afforded the partners in Thematic Area A of the ISR Associated Laboratory a state-of-the-art tool for bathymetric mapping.



Multibeam Sonar (IST/ISR) installed in the AGUAS VIVAS vessel, property of IMAR/DOP/UAçores.

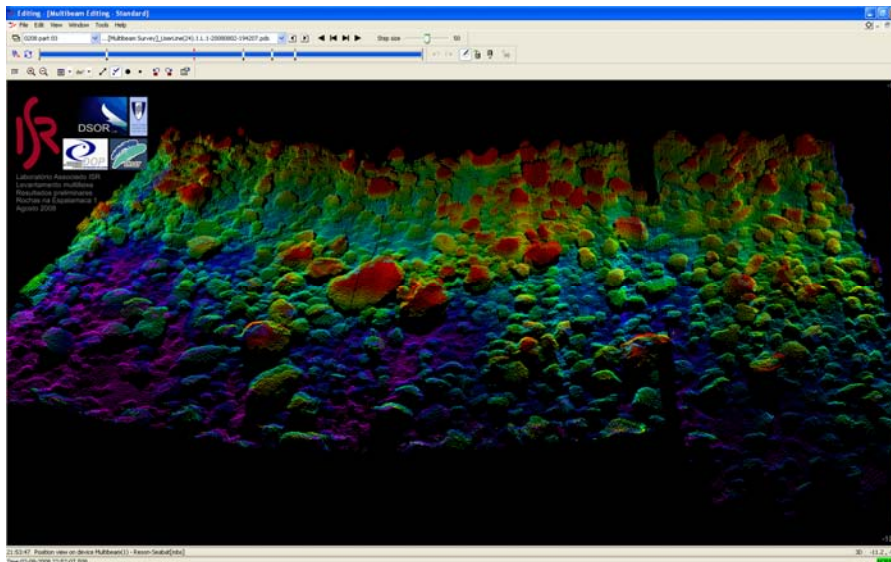

Very high resolution acoustic image of the seabed obtained by ISR/IST-IMAR/DOP/UAçores in 2008, off the coast of Espalamaca, Horta, Faial.



The DELFI-Mx Autonomous Robotic Vehicle Following the “unknown” AGUAS VIVAS target: first experiments of cooperative motion control in the Azores, in the scope of the European GREX project.

2 RESEARCH ACTIVITIES

2.1 RESEARCH PROJECTS

This section contains a brief description of the R&D projects in progress at ISR (Lisbon), IST and University of Algarve during 2008, under the supervision of ISR members. The subsections define the main areas of intervention where the projects are being developed. The projects resulting from contracts celebrated with ISR and managed by this private research institution are identified by (*) on the title; all the remaining projects refer to contacts celebrated and managed by IST and University of Algarve.

Project name: FREESUBNET - Marie Curie Research Training Network

Project leader within ISR: Prof. Antonio Pascoal (ISR/IST)

Project description: The purpose of FREESUBNET is to provide a European-wide excellence in quality training to young and experienced researchers in the emerging field of Cooperative Autonomous Intervention Underwater Vehicles (AUVs), which are steadily becoming the tool par excellence to carry out missions at sea without tight human supervision. In the scope of the network, an intersectorial consortium (HE, RES, and IND) with expertise in different but complimentary disciplines (engineering, marine science, physics and informatics) is carrying out outstanding research in the context of four strategic application fields (underwater archaeology, maritime security, marine science and energy assessment). The network aims to establish a bridge between academia and industry and to promote the integration of a number of research groups throughout Europe.

URL: <http://www.freesubnet.eu/>

Research Areas: Navigation, Guidance, and Control, Acoustic Cooperative Motion Control, Underwater Positioning and Communications, Networked Control

Laboratories: Dynamical Systems and Ocean Robotics Lab, Signal and Image Processing Group, and Computer and Robot Vision Lab

Project Partners: 15 European partners

Initiated: 2006

Expected conclusion: 2010

Classification: MRTN-CT-2006-036186



Project name: VENUS - Virtual ExploratioN of Underwater Sites

Project leader within ISR: Prof. António Pascoal (ISR/IST)

Project description: The VENUS project aims at providing scientific methodologies and technological tools for the virtual exploration of deep underwater archaeology sites. Underwater archaeological sites, for example shipwrecks, offer extraordinary opportunities for archaeologists due to factors such as darkness, low temperatures and a low oxygen rate which are favourable to preservation. On the other hand, these sites cannot be experienced first hand and today are continuously jeopardised by activities such as deep trawling

that destroy their surface layer. The VENUS project will improve the accessibility of underwater sites by generating thorough and exhaustive 3D records for virtual exploration.

The project team plans to survey shipwrecks at various depths and to explore advanced methods and techniques of data acquisition through autonomous or remotely operated unmanned vehicles with innovative sonar and photogrammetry equipment. Research will also cover aspects such as data processing and storage, plotting of archaeological artefacts and information system management. This work will result in a series of best practices and procedures for collecting and storing data. Further, VENUS will develop virtual reality and augmented reality tools for the visualisation of an immersive interaction with a digital model of an underwater site. The model will be made accessible online, both as an example of digital preservation and for demonstrating new facilities of exploration in a safe, cost-effective and pedagogical environment. The virtual underwater site will provide archaeologists with an improved insight into the data and the general public with simulated dives to the site.

URL: <http://dsor.isr.ist.utl.pt/Projects/Venus/>

Research Areas: Archaeology, Underwater technology, Virtual reality

Laboratories: Dynamical Systems and Ocean Robotics Lab, Signal and Image Processing Group, and Computer and Robot Vision Lab

Project Partners: CNANS - Portuguese Institute of Archaeology (PT), CNRS (FR), COMEX (FR), ISM - Università degli Studi di Genova (IT), IST/ISR - Instituto Superior Técnico/Institute for Systems and Robotics (PT), LFUI - Leopold-Franzens-Universität Innsbruck (AT), MCC - Department for Underwater and Undersea Archaeological Research (FR), MIBAC-SBAT - Soprintendenza Beni Archeologici della Toscana (IT), SIMVIS - University of Hull (UK), UEVE - Université d'Evry Val d'Essonne (FR), UoY-ADS University of York (UK)

Initiated: Jul. 2006

Expected conclusion: Jun. 2009

Classification: EU-FP6-IST- 034924



Project name: GREX - Coordination and Control of Cooperating Heterogeneous Unmanned Systems in Uncertain Environments

Project leader within ISR: Prof. António Pascoal (ISR/IST)

Project Description: Due to the limitations of state-of-the-art embedded systems, marine vehicles are subjected to strict constraints in both their autonomy and capabilities. It would be a leap ahead if a researcher could use a multiple vehicle approach, whereby each vehicle plays the role of a sophisticated node (with sensor, processing, and communication capabilities) in a possibly large network - this means combining the properties of different systems in a team. Grex - the latin word for a herd or flock - suggests the focus of the project: to create a conceptual framework and middleware to coordinate a flock of heterogeneous robotic vehicles in order to achieve a well defined practical goal in an optimised manner.

The main goal of the project is to achieve a first level of distributed "intelligence" through dependable embedded systems that are interconnected and cooperate towards the coordinated execution of tasks. Thus the project will witness the development of theoretical methods and practical tools for multiple vehicle cooperation, bridging the gap between concept and practice. The technology developed must be on one hand sufficiently generic in order to interface preexisting heterogeneous systems. On the other hand it must be sufficiently robust to cover problems caused by faulty communications. From a practical standpoint, the

developments will cover methods for effective programming of multiple systems, coordinated mission control and navigation, formal methods for validation and testing of the programming languages, and the use of perception and communication techniques to enable ad hoc formation of information - and sensor-networks. A series of field trials with autonomous marine robots will be carried out to assess the efficacy of the methods developed under stringent acoustic communication constraints.

URL: <http://dsor.isr.ist.utl.pt/Projects/Grex/>

Research Areas: Embedded Systems, Communication Technology, Ad Hoc Networking, Unmanned, Underwater Vehicles, Cooperation, Navigation, Swarm, Flock, Maritime Research

Laboratories: Dynamical Systems and Ocean Robotics Lab, Signal and Image Processing Group, and Computer and Robot Vision Lab

Project Partners: ATLAS Elektronik (DE), IFREMER (FR), IMAR-DOP/University of the Azores (PT), INNOVA (IT), IST/ISR Instituto Superior Técnico/Institute for Systems and Robotics (PT), MC Marketing Consulting (DE), SCIAN (BG), SEEBYTE (UK), TU Ilmenau (DE)

Initiated: Jun. 2006

Expected conclusion: Jun. 2009

Classification: EU-FP6-IST-035223



Project name: DENO - DEvelopment of Nonlinear Observers

Project leader within ISR: Prof. António Aguiar (ISR/IST)

Project Description: During the last few decades there has been an extensive study on the design of observers for nonlinear systems. An observer or estimator can be defined as a process that provides in real time the estimate of the state (or some function of it) of the plant from partial and possibly noisy measurements of the inputs and outputs and inexact knowledge of the initial condition. The aim of this project is to Develop Nonlinear Observers (DENO) that are provably accurate by construction. In particular, to assure that the research is driven by high-impact application areas, the DENO project will focus on the following class of nonlinear observers:

- Minimum-energy and H-infinity state estimators for systems with implicit outputs;
- Range observers;
- Multi-model adaptive estimators;
- State estimators of networked systems.

URL: <http://users.isr.ist.utl.pt/~pedro/DENO>

Research Areas: Nonlinear Observers; Multi-model adaptive estimators; Minimum-energy and H-infinity observers; Sensor networks

Laboratories: Dynamical Systems and Ocean Robotics Lab

Project partners: Center for Control, Dynamical-systems, and Computation - University of California Santa Barbara (USA), Instituto de Sistemas e Robótica - Universidade de Coimbra (P)

Initiated: Sep. 2007

Expected conclusion: Aug. 2010

Classification: FCT - PTDC/EEA-ACR/67020/2006

Project name: HELICIM - Autonomous Helicopter for Critical Infrastructure Monitoring

Project leader within ISR: Prof. Carlos Silvestre (ISR/IST)

Project Description: Structural health monitoring plays a major role in maintaining large critical infrastructures like bridges, breakwaters, dams, gas and water supply networks, and transport pipelines, which in general require complex and expensive routine inspections and maintenance procedures. Most of these structures are exposed to harsh environments and heavy loads and some of them (like rubble-mound breakwaters) are designed, due to their characteristics, under the proviso that maintenance and protection works will certainly be required during the structure's life. The cost of the structure, its expected behavior, as well as the consequences of its failure, do completely justify the existence of a monitoring program, which will help in the decision making process relative to optimal timing and extension of maintenance, or even repair, works. This process should be based on the structure diagnosis, which, in turn, should rely on a set of state variables that clearly characterize the health of the structure.

Accurate health monitoring and diagnosis of critical infrastructure will increase the efficiency of maintenance and repair plans, with inherent benefits in terms of cost reduction and damage minimization in case of disaster. This presents an opportunity for the development of advanced robotic surveying tools, namely uninhabited aerial vehicles (UAVs) equipped with state of the art laser, multi-spectral and hyper-spectral remote sensing devices, high accuracy inertial platforms, and positioning systems. These vehicles should be able to perform high accuracy tri-dimensional surveys of structures with the objective of producing, in real time, accurate data sets with the required spatial and temporal resolutions and thereby providing quantitative information vital for a well-founded diagnosis.

Recent advances in sensor technology and the increasing availability of computational capacity are steadily affording UAVs higher degrees of robustness and reliability in challenging operation scenarios, taking place in uncertain and possibly remote environments. Unlike fixed-wing aircraft, helicopters were designed to execute vertical flight maneuvers, including hovering and vertical take-off and landing (VTOL). The trade-off for such maneuverability is an inherent complexity that translates into a highly nonlinear and unstable dynamical system with wide parameter variations over the vehicle's flight envelope.

Motivated by the foregoing considerations, the aim of this Project is to develop an Autonomous Helicopter specially tailored for critical infrastructure monitoring by means of collision avoidance mechanisms and absolute and sensor-based navigation and tracking control laws, which rely on the aircraft's advanced sensing devices and exploit the properties of the configuration space to express the dynamics of flying robots, that is the special Euclidean group $SE(3)$. In preparation for future monitoring and inspection scenarios that can require the use of multiple helicopters equipped with complementary sensing devices, additional research effort will be placed on the area of cooperative control of multiple Autonomous Helicopters.

The development of such a system involves a wide range of research topics, including dynamic modeling and identification, navigation, guidance and control, real time systems, and mission control. This project team has already addressed some theoretical aspects of these topics within the scope of previous projects. Based on the work formerly developed, the current project will focus both on developing the experimental components and on extending the theoretical results previously obtained within the fields of guidance, navigation, and control. The resulting UAV will be equipped with a distributed real time computing network, a reliable wireless communication system, and sensing devices. Given the envisaged applications, the latter include inertial sensors, a GPS, a laser range finder, and a camera array composed by a digital video camera and an infrared camera.

The camera array will be mounted on a pan-tilt unit. To reject the low frequency oscillations induced by the vehicle and stabilize the camera's image, a closed loop control system will be implemented whereby the pan and tilt motions of the camera are compensated based on image data and inertial information provided by the aircraft's navigation system. It is then possible to direct the camera array to a specified target and ensure that it keeps a steady image, regardless of the pose assumed by the helicopter while maneuvering or even under wind induced disturbances.

The research work will focus on bridging the gap between theory and practice, by taking into account actual characteristics of the systems at hand in the development process. Evaluation of system components' reliability and of overall performance will be carried out in a controlled environment resorting to Hardware In-the-Loop Simulation to reduce both the number of required field trials and their associated risk factors.

Laboratories: Dynamical Systems and Ocean Robotics Lab

Initiated: Oct. 2007

Expected conclusion: Sep. 2010

Classification: FCT - PTDC/EEA-ACR/72853/2006



Project name: NAV - Development and Application of Advanced Nonlinear Control Techniques for the Coordination and Motion Control of a Network of Autonomous Vehicles

Project leader within ISR: Prof. António Aguiar (ISR/IST)

Project Description: The goal of this project is to develop, implement and test advanced robust control strategies for the coordination and cooperative motion a network of autonomous vehicles (NAV). The emphasis will be placed on the field of autonomous marine robots for two fundamental reasons: i) the highly nonlinear dynamics of marine vehicles pose formidable challenges to control system designers, and ii) autonomous marine vehicles are steadily becoming the tool par excellence to acquire scientific data at an unprecedented scale. However, the research done in the field of marine robots can certainly be adapted to land, air, and space vehicles.

The NAV-Control project combines two important and complementary components: fundamental research and applications. At a theoretical level, we propose to develop a set of control tools and algorithms that explicitly address the dynamics of the vehicles and the constraints imposed by the topology of the inter-vehicle communications network. Obtaining formal proofs of robustness and stability of the control algorithms is a key objective. At practical level, one key objective of NAV-Control is to build an experimental platform consisting of several low-budget tiny autonomous underwater vehicles (AUVs) (or semi-submersible AUVs) with embedded computing and communication capabilities, allowing them to perform cooperative tasks in a test tank. The testbed will allow for the simulation of different communication topologies and failures, two of the key issues that must be addressed at a theoretical level. Another objective is to assure that the research is driven by the high-impact field of marine robotics. It is expected that the methodologies and techniques developed in NAV-Control will contribute to the development of important tools for ocean exploration and exploitation.

URL: <http://users.isr.ist.utl.pt/~pedro/NAV>

Research Areas: Coordinated motion control of autonomous vehicles; Nonlinear control theory; Autonomous marine vehicles; Networked control systems

Laboratories: Dynamical Systems and Ocean Robotics Lab

Project partners: Center for Control, Dynamical-systems, and Computation - University of California Santa Barbara (USA), Institute of Marine Research, Department of Oceanography and Fisheries, University of the Azores, Horta, Portugal (IMAR Açores)

Initiated: Oct. 2007

Expected conclusion: Sep. 2010

Classification: FCT - PTDC/EEA-ACR/65996/2006



Project name: OBSERVFLY - Uninhabited Aircraft for Marine Science Applications

Project leader within ISR: Prof. Carlos Silvestre (ISR/IST)

Project Description: In recent years, there has been an increasing interest in developing and using Uninhabited Air Vehicles (UAVs) as tools for ocean surface data acquisition. However, the use of UAVs for ocean applications is still limited to a few scientific institutions scattered worldwide, and most vehicles have been designed to conduct simple survey missions that in general do not require close interaction between the operator and the environment. It is by now felt that the effective use of UAVs in demanding marine science applications must be clearly demonstrated, namely by evaluating the system in terms of adaptability to different missions scenarios, maritime launch and recovery, survivability, autonomy, endurance, payload performance and usability, and system integration with the existent marine science instrumentation. Meeting these stringent requirements poses considerable challenges to marine scientists, system designers, and developers.

This project represents a step towards meeting those goals. Specifically, it aims at developing a versatile UAV prototype that can take-off and land either on an opportunity airstrip (using the landing gear) or on a bay or harbor (as a seaplane). The aircraft will be designed for marine science applications with special emphasis on the location and tracking of marine mammals and commercially important or threatened pelagic species such as the Atlantic Tuna. Further applications include sea surface temperature measurement and specialized data acquisition for faster identification and better understanding of features like eddies and air sea interaction. The use of UAVs in marine science applications can be foreseen as tool for directing research vessels to new areas of interest, enabling a more efficient use of ship time.

The main focus of this proposal is on the design and construction of the aircraft itself, and on the development and integration of advanced systems for vehicle navigation, guidance and control, payload command, telemetry, and mission control. In preparation for future operation scenarios that can involve multiple air vehicles, additional research effort will be placed on the areas of flight formation and cooperative control of multiple UAVs.

System design, implementation and test will be guided by the requirements of a number of realistic mission scenarios, including those of two scientific missions devoted to tuna fish schools detection and cetacean location and tracking, to be undertaken in the Azores during the second and third years of the project. Laboratory pre-testing of the systems developed using hardware-in-the-loop simulation and flight testing of the complete UAV prototype in an airfield will precede the actual missions at sea. A predefined set of operational modes, which range from remotely operated to fully autonomous, will illustrate the capability of the aircraft and systems developed to perform the sequence of steps that are required to program and execute scientific missions in the ocean.

The avionic system for the UAV builds on similar systems that have been fully developed by members of the proposing team over the past few years. The degree of miniaturization achieved will make it possible to install

the avionics in a small water proof container that can be easily mounted on and removed from the aircraft for inspection. To implement the avionics, a DSP based computer architecture is used, allowing for easy interfacing with the data acquisition hardware through a distributed architecture built around the CAN Bus and Ethernet. The Navigation System to be developed and installed onboard the UAV uses advanced aiding techniques to enhance error estimation in low-cost strap-down inertial navigation systems. New sensor-based control techniques resorting to a radar altimeter will be explored to implement terrain following controllers, thus enabling the vehicle to fly at a constant desired distance from the ocean surface or ground. Applications to automatic takeoff and landing maneuvers will be developed, implemented, and tested in the platform.

The UAV will also be instrumented with an image acquisition module, which consists of a digital video camera mounted on a pan-tilt unit. To deal with low frequency oscillations, a closed loop control system is used for stabilizing the image by commanding the pan and tilt motions of the camera based on inertial information available from the aircraft navigation system. It is then possible to ensure that the acquired images present a smooth behavior so that a steady image of the ocean surface can be kept at all times, regardless of the pose assumed by the airplane while maneuvering or even under wind induced disturbances.

Laboratories: Dynamical Systems and Ocean Robotics Lab

Project partners: IMAR-DOP/University of the Azores (PT), ISR/IST (PT)

Initiated: Nov. 2008

Expected conclusion: Oct. 2011

Classification: FCT - PTDC/MAR/64546/2006



Project name: RUMOS - Robotic Underwater Vehicles and Marine Animals Tracking Systems

Project leader within ISR: Prof. Paulo Oliveira (ISR/IST)

Project Description: The main purpose of the project is the development of a set of devices and methodologies for precise estimation of trajectories of underwater robotic vehicles (autonomous and remotely operated) and marine animals.

In order to overcome the problems that occur due to the highly noise environment and the presence of a multitude of disturbances a number of efforts must be set forth to overcome the problem at hand.

The topics include:

- i) Mission scenario characterization;
- ii) Development of high gain power amplifiers for acoustic wave generation;
- iii) Development of very-low noise acoustic data acquisition systems;
- iv) Study and development of accurate navigation algorithms for sensor fusion;
- v) Development of post-processing techniques for very precise trajectories estimation;
- vi) Accurate and real-time monitoring of 3D trajectories in selected coastal and oceanic fish species.

Research Areas: Underwater Positioning Systems, Tracking Systems, Sensor Fusion, Behavior and Ecology of Fishes

Laboratories: Dynamical Systems and Ocean Robotics Lab

Project partners: IMAR/ Department of Oceanography and Fisheries, Univ. Azores

Initiated: 2005

Expected conclusion: 2008

Classification: FCT - POCI/MAR/55609/2004

Project name: SADOGEOROB - Coastline variations, neotectonics and evolution of the Sado submarine delta during the Quaternary: an integrated geological and marine robotics approach

Project leader within ISR: Prof. António Pascoal (ISR/IST)

Project Description: This project was designed to bring together scientists involved with the development of marine robotics and geo-marine scientists traditionally involved in the research of recent tectonics, seismic reflection processing and sedimentary processes related to sea level variations and global climatic changes.

The collaboration between earth science and marine robotics scientists will enrich both groups by testing the autonomous surface and underwater vehicles developed by IST and, on the other hand, by providing the earth scientists with the insight towards newer technologies. It is hoped that this collaboration will contribute to make acquisition of marine data cheaper and less fastidious for earth scientists. The marine robotics scientists will be acquainted with the needs of earth scientist and also profit from testing their equipment in real conditions of data acquisition.

Since the group of geo-marine scientists already have substantial experience of data acquisition at sea in quite different geological settings, weather conditions and types of equipment, this collaboration will certainly be fruitful for both groups because the quality, logistics and cost of the acquired data can easily be judged. The geo-marine scientists will benefit from the fact that autonomous vehicles do not need a permanent scientific crew, can be equipped with different instrumentation and allow the study of geological objects at different distances, i.e. scales.

From the geological point of view this project will certainly be an important contribution to the knowledge of the effects of sea level variations on the sedimentary architecture of the Quaternary upper shelf. In the past most studies in the area of the Sado submarine delta and encompassing area concentrated only on dating short cores in estuarine sediments and interpretation of low resolution bathymetry. This project will acquire data that will allow a three dimensional geometrical model of the sedimentary sequences and thus an interpretation of the vertical oscillations of the sea level versus the sediment supply and also the importance of local and regional tectonics. The study area encompass the coast between Cabo da Roca (~38°46'N) and Comporta (~38°20'N), i.e. approximately 100km of a coastal segment that comprehends the cities of Lisbon and Setubal which have been strongly affected by earthquake destruction (Vilanova et al.2004). Borges et al. (2001) also showed instrumental epicentres located at the Sado estuary and calculated the stress field. The various high resolution types of surveys of this project will also test the possibility of finding surface earthquake rupture in this submarine area and thus contribute with new data for the seismic risk estimation of the Lisbon – Setubal area, the most densely populated of Portugal. Dating of coastal “uplifted” and “submerged” deposits along this segment of the Portuguese coast will help to establish the existence or absence of recent tectonics in the study area.

Research Areas: Coastline variation, seismotectonics, sedimentary dynamics, marine robotics

Laboratories: Dynamical Systems and Ocean Robotics Lab

Project partners: Faculdade de Ciências da Universidade de Lisboa (PT), INETI (PT), Instituto Superior Técnico (PT), Universidade de Aveiro (PT)

Initiated: 2005

Expected Conclusion: 2008

Classification: FCT POCI/MAR/61178/2004

Project name: SocRob - Soccer Robots or Society of Robots



Project leader within ISR: Prof. Pedro Lima (ISR/IST)

Project description: This project fosters general research on cooperative robotic systems, aiming at introducing methodologies for collaborative teamwork, driven by results from Multi-agent and Discrete Event Systems theory. Its current case study is on Soccer Robots, with regular participations in RoboCup. The major contributions in this period concerned i) the introduction of a general motion control method for omnidirectional robot which can be particularized for intercepting a freely rolling soccer ball and transporting the ball across the field, including obstacle avoidance, and ii) a multi-robot/sensor cooperative object detection and tracking method based on a decentralized Bayesian approach which uses particle filters to avoid simplifying assumptions about the object motion and the sensors' observation models. The proposed solution for the ball interception problem combines the concepts of trajectory-tracking and proportional navigation. Ball transportation is accomplished through a solution that extends the concepts of hybrid force/position control to holonomic mobile robots. An obstacle avoidance algorithm is also presented that can be readily adapted for each of the two tasks. The cooperative perception method is composed of a local filter and a team filter. The local filter receives a reduced dimension representation of its teammates' sample belief about the object location, i.e., the parameters of a Gaussian Mixture Model (GMM) approximating the other sensors' particles, and mixes the particles representing its own belief about the object location with particles sampling the received GMM. All particles are weighted by the local observation model and the best ones are re-sampled for the next local iteration. The team filter receives GMM representations of the object in the world frame, from the sensor teammates, and fuses them all performing Covariance Intersection among GMM components. The local estimate is used when the sensor sees the object, to improve its estimate from the teammates' estimates. The team estimate is used when the sensor does not see the object alone. To prevent the fusion of incorrect estimates, the disagreement between estimates is measured by a divergence measure for GMMs.

Research Areas: Cooperative Perception, DES Plan Representation, Robot Task Modelling and Analysis, Cooperative Task Execution, Teamwork, Middleware and Architectures for Multi-Robot Systems

Project partners: Instituto Superior Técnico (IST)

Laboratories: Intelligent Systems Lab

Initiated: 1997

Expected conclusion: N/A

Classification: N/A



Project name: Dec-PUCS - Decentralized Planning under Uncertainty for Cooperative Systems

Project leaders within ISR: Dr. Matthijs Spaan, Prof. Pedro Lima (ISR/IST)

Project description: In this project we study planning under uncertainty for groups of cooperating multiagent systems. Developing intelligent robots or other real-world systems that plan and perform an assigned task is a major goal of Artificial Intelligence and Robotics. We develop general methodology and algorithms, and tackle two case studies relevant to society: multi-robot urban search and rescue, and irrigation channel control. Planning, or sequential decision-making skills form a crucial component of any intelligent system: how should a system act over time in order to perform its task as well as possible. When a system is part of a team, its performance depends on the actions chosen by its teammates. An important aspect of decision making in a real-world system is the fact that the system should be able to deal with uncertainty from numerous sources. For instance, a major source of uncertainty for a robot is its sensors, which are often noisy and have only a

limited view of the environment. A robot is also often uncertain about the effect that executing an action has on its environment. A third source of uncertainty are an agent's teammates, as, in general, an agent will not be able to predict with full certainty what actions its teammates will perform. Furthermore, one has to consider the communication abilities available to each system and restrictions on available bandwidth or network reliability. We develop algorithms that allow systems to handle uncertainty in sensors, actuators, communication, and teammate behavior in a principled way. We capture uncertainty in probabilistic models, which allows us to model the sequential decision-making problem as a centralized or decentralized partially observable Markov decision process (POMDP). Decentralized POMDPs (DEC-POMDPs) form a general framework for representing cooperative planning under uncertainty problems. In this project, we focus on the following issues: (1) developing approximate planning algorithms for relevant subsets of the general DEC-POMDP model, (2) examining the tradeoff between centralized vs. decentralized planning algorithms and (3) tackling various communication models. Furthermore, we will see how these techniques can be used in two case studies.

Research Areas: Planning under uncertainty, POMDPs

Laboratories: Intelligent Systems Lab

Project partners: Instituto Superior Técnico (IST)

Initiated: Oct. 2007

Expected conclusion: Sept. 2010

Classification: PTDC/EEA-ACR/73266/2006



Project name: URUS- Ubiquitous Networking Robotics in Urban Settings

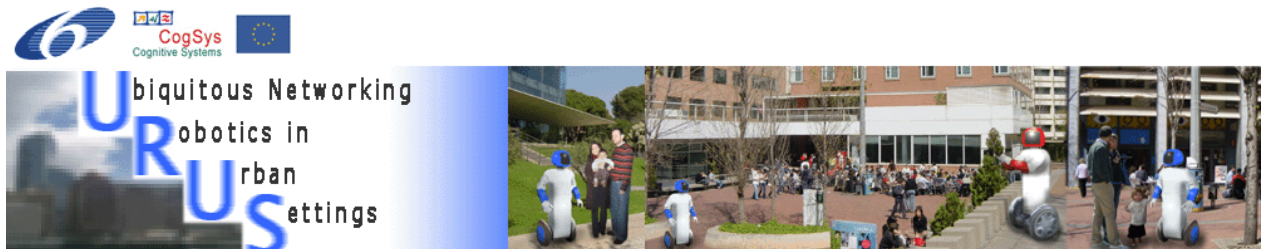

Project leaders within ISR: Profs. João Sequeira and José Santos-Victor (IST/ISR)

Project description: This project aims at analyzing and testing the use of networks of robots and intelligent sensors to surveillance and assistance to pedestrians in urban environments. Different sets of heterogeneous robots are used to (i) drive people through escape routes in emergency situations and (ii) to assist in people and goods transportation in urban settings. These experiments were chosen as they embed the key functionalities that can be expected to be used when robots interact with humans in urban settings.

Besides the robots and control computers, the network includes also video cameras, acoustic sensors, PDAs and cellphones. The demonstrations will take place in an urban area in the city of Barcelona, Spain.

In this project coordinates the Human-Robot interaction workpackage and the design of the global architecture for the surveillance experiment.

Research Areas: Cooperative Robotics, Human-Robot Interaction, Navigation

Laboratories: Mobile Robotics, Vision Lab, Intelligent Systems Lab

Project partners: Instituto Superior Técnico (IST), Universitat Politècnica de Catalunya (UPC), Universidad de Zaragoza (UniZar), Scuola Superiore di Studi Universitari e di Perfezionamento Sant'Anna (SSSA), The University of Surrey (UniSurrey), Centre National de la Recherche Scientifique (CNRS/LAAS), Eidgenössische Technische Hochschule Zurich (ETHZ), Robotech SRL, Telefonica Investigación y Desarrollo SA Unipersonal, Agencia d'Ecologia Urbana de Barcelona, Asociación de la Investigación y Cooperación Industrial de Andalucía (AICIA)

Initiated: Sept. 2006

Expected Conclusion: Dec. 2009

Classification: FP6-2005-IST-6-045062



Project name: RIOL - Robotic Inspection over Power Lines

Project leader within ISR: Prof. João Sequeira (IST/ISR)

Project description: The project aims at developing a prototype robot able to move over electric power lines. Typical missions for such robot include line inspection, wildlife and forestry fire monitoring. In particular, line inspection is commonly made through direct visual observation of images in the area of infrared and visible light by experts traveling onboard helicopters. This represents an expensive and dangerous task for the human operators and hence the project contains a relevant social and economical component.

The proposed robot differs from common approaches that can be found in the literature in that it uses the line as support for the locomotion gait.

The project ended by August 2008. A prototype robot was built and the key results are covered by a national patent (PCT application also submitted).

Research Areas: Robotics (all contributing fields).

Laboratories: Intelligent Systems Lab, Mobile Robotics Lab, Computer Vision Lab

Initiated: Dec. 2003

Expected conclusion: Aug. 2008

Classification: EC Contract No. 507728



Project name: SIMBAD – Beyond Features: Similarity-Based Pattern Analysis and Recognition

Project leader within ISR: Prof. Pedro Aguiar (IST/ISR)

Project description: Traditional pattern recognition techniques are centered around the notion of "feature". According to this view, the objects to be classified are represented in terms of properties that are intrinsic to the object itself. Hence, a typical pattern recognition system makes its decisions by simply looking at one or more feature vectors provided as input. The strength of this approach is that it can leverage a wide range of mathematical tools ranging from statistics, to geometry, to optimization. However, in many real-world applications a feasible feature-based description of objects might be difficult to obtain or inefficient for learning purposes. In these cases, it is often possible to obtain a measure of the (dis)similarity of the objects to be classified, and in some applications the use of dissimilarities (rather than features) makes the problem more viable. In the last few years, researchers in pattern recognition and machine learning are becoming increasingly aware of the importance of similarity information per se. Indeed, by abandoning the realm of vectorial representations one is confronted with the challenging problem of dealing with (dis)similarities that do not necessarily obey the requirements of a metric. This undermines the very foundations of traditional

pattern recognition theories and algorithms, and poses totally new theoretical and computational questions. In this project we aim at undertaking a thorough study of several aspects of purely similarity-based pattern analysis and recognition methods, from the theoretical, computational, and applicative perspective. We aim at covering a wide range of problems and perspectives. We shall consider both supervised and unsupervised learning paradigms, generative and discriminative models, and our interest will range from purely theoretical problems to real-world practical applications.

Laboratories: Signal and Image Processing Lab.

Research Areas: pattern recognition, computational learning

Project partners: Università Cá Foscari di Venezia, University of York, Technische Universiteit Delft, Università degli Studi di Verona, Eidgenoessische Technische Hochschule Zuerich.

Initiated: April 2008

Expected conclusion: March 2011

Classification: FT7-ICT-2007-C, grant 213250



Project name: MODI – 3D Models from 2D Images

Project leader within ISR: Prof. Pedro Aguiar (IST/ISR)

Project description: Motivated by applications in fields that range from robotics to virtual reality, the automatic generation of a 3D description of the real world environment has received the attention of a large number of researchers. Naturally, the use of expensive range sensors, i.e., sensors that provide explicit information about the 3D structure of the environment in front of it, and/or accurately calibrated video cameras, has led to successful results. However, in many cases only uncalibrated video images are available, due to either obvious economic reasons, or the specific nature of the applications, e.g., modern content-based representations for digital video. Inferring 3D content from 2D images has been one of the overall goals of the Computer Vision research field. In this project, we will step further toward that goal. Although the quest for the automatic understanding of 3D scenes has been around since the early days of Computer Vision, only recently, tools such as modern large-scale optimization techniques and statistical model-based methods, came into scene. In this context, we will address three main research topics: the correspondence problem, the analysis of non-rigid scenes, and featureless methods for 3D analysis. In a general scenario, when inferring 3D content from a set of 2D images (obtained either by moving a single camera or by using a set of cameras), a key issue is the correspondence problem, i.e., the problem of determining which feature point in each 2D image corresponds to the same 3D point. This problem is usually solved in a local way, leading to inaccurate results. In opposition, we will use global constraints and develop non-convex large-scale optimization techniques to compute the globally optimal solution to the complete set of correspondences in a set of images. A crux of most approaches to the automatic inference of 3D content is the underlying assumption of scene rigidity. In fact, these approaches can not deal with time-varying object shapes, which severely limits their application, since, for instance, most biological shapes are intrinsically deformable (skin, organs) or articulated (bones). In this project, we seek to generalize the rigidity assumption and come up with optimization techniques able to deal with both problems of computing correspondences between 2D images and inferring 3D content, in a non-rigid world. The research line outlined above, as the majority of current methods, is based on an intermediate step that computes local features, e.g., image points. This intermediate step, in general computationally expensive, is often seen as the bottleneck of current solutions for the problem of inferring 3D models from 2D images. In contrast, featureless methods, i.e., methods that process directly the whole image data, without computing inter-image correspondences of pointwise features, have succeeded in more constrained scenarios. In this project, we will use statistical modelling techniques to develop

new featureless methods that provide partial descriptions of the 3D world. These descriptions will also enable innovative research lines that combine featureless methods with feature-based ones.

Research Areas: Computer vision

Laboratories: Signal and Image Processing Lab.

Initiated: Jan. 2008

Expected conclusion: Dec. 2010

Classification: PTDC/EEA-ACR/72201/2006



Project name: DELKETI – Development and Learning of Kernels for Text and Images

Project leader within ISR: Prof. Pedro Aguiar (IST/ISR)

Project description: Kernel-based methods caused a true revolution in the theory and practice of machine/statistical learning, namely because they allowed adapting classical linear algorithms to the non-linear realm. Recently, kernel methods were further extended to non-vectorial data (strings, trees, graphs, images) with great success. A well known fact is that the performance of kernel-based methods depends heavily on the adequacy of the kernel to the particular problem at hand. This has caused a recent research trend, aiming at approaches which are able to learn "good" kernels directly from training data. This project proposes to contribute to the area of kernel development and learning, with special emphasis on kernels for structured data, such as text or images. More specifically, the proposed project will contribute in the following topics:

1. Universal dissimilarity/distance functions, based on Kolmogorov and Shannon information theories, have been recently proposed. In principle, these dissimilarities will enable defining "universal kernels". We aim at developing techniques to approximate the universal dissimilarity for several types of structured data, such as text and images. This goal will be pursued by using the known ability of compression algorithms (of the Lempel-Ziv type, in the case of text) to approximate the universal distance.
2. "Kernelized" versions of most algorithms for statistical supervised, non-supervised, and semi-supervised learning tasks have been proposed (e.g., support vector machines, kernel Fisher discriminants, kernel principal component analysis). Accordingly, we will be able to plug the (approximate) universal kernels mentioned above into any kernel-based algorithm, thus extending their applicability to a wide range of structured data types.
3. Kernels implemented via (universal) compression algorithms are necessarily approximations to the theoretical universal kernels. In some cases, these compression-based kernels converge (asymptotically in the sequence length) to the theoretical counterpart, but it is not clearly understood how they behave for finite (small) samples. In this project we will study this problem, aiming to derive concentration bounds for these kernels.
4. An alternative to tailoring kernels to specific problems or using universal-type kernels is to develop algorithms that learn "good" kernels directly from training data. In this project, we will work along this research direction. One of the main goals here, will be to learn optimal combinations of universal kernels for heterogenous data (e.g., classification of web pages, which involve multiple data types: text, links, images).
5. At a final stage of the project, the several kernel-based methods mentioned above will be applied to address problems in text and image analysis. Namely we will target central language processing problems, such as categorization, disambiguation, clustering, and summarization, as well as image analysis tasks, such as image/video classification and content-based image retrieval.

Research Areas: Machine learning

Laboratories: Signal and Image Processing Lab

Project partners: Instituto de Telecomunicações, Priberam Informática

Initiated: Jan. 2008

Expected conclusion: Dec. 2010

Classification: PTDC/EEA-TEL/72572/2006



Project name: SIPM – Signal and Image Processing on Manifolds

Project leader within ISR: Prof. João Xavier (IST/ISR)

Project description: Most signal processing algorithms are developed within the framework of flat Euclidean spaces: the input/output data spaces of the processing system are vector spaces. This explains the pervasive presence of Linear Algebra in almost any signal processing technique currently available. However, several important real world problems do not fit into this simple linear framework. Commonly, the data lives in a nonlinear, curved set. In particular, it is often the case that the input/output data spaces are instances of a Riemannian manifold (a nonlinear, curved yet smooth, metric space). Representative examples: (i) wind-direction readings in meteorology are time-series on the unit-circle (curved input space); (ii) estimation of the relative rotations of Earth's tectonic plates leads to the nonlinear group of orthogonal matrices; (iii) subspace tracking based on multiple-antenna arrays is nothing more than inference on the Grassmann manifold. When dealing with problems which cannot be captured within the usual Euclidean framework, it is common to resort to ad hoc solutions or to attempt some local linear approximations: the underlying global Riemannian manifold structure is ignored. It is expected that new techniques exploiting this additional structure will significantly outperform current state-of-art solutions. These techniques should be rooted in the field of Differential Geometry (DG) as it provides a systematic framework to address a large class of nonlinear problems on manifolds. Successful applications of DG techniques in signal and image processing have started to be reported in the past few years. A showcase can be found in several plenary and special sessions (dedicated to this topic) which have been held recently at the major signal processing conferences: the IEEE Int. Conf. on Acous., Sp. and Sig. Proc. (IEEE ICASSP 2005) Phil., USA and (IEEE ICASSP 2006) Toulouse, France and the IEEE Workshop on Sig. Proc. Advances in Wireless Comm. (IEEE SPAWC 2004) Lisbon, Portugal (sponsored by the NSF, USA). This indicates that the signal processing community has recognized the great potential of this mathematical framework (already proved fruitful in other fields of engineering: control theory). This project's Principal Investigator (PI) was a participant in all the aforementioned special sessions. The broad aim of this project is to enrich the toolkit of the signal processor with a set of new tools which enable him to solve efficiently basic problems posed in manifolds, e.g., filtering, modelling, learning, optimizing a function, etc. This is to be accomplished by capitalizing on the expertise of the research team on the fields of manifold theory, wireless communications, image processing and advanced mathematics to develop both fundamental theory applicable to general engineering problems and to derive new algorithms for specific applications. Regarding fundamental theory, representative topics are: (a) performance bounds and (b) stochastic modelling. (a) In any given estimation problem, it is crucial to know the fundamental limit for the accuracy of estimators. These limits dictate what can/cannot be done for the given problem. Popular bounds, such as the Cramer-Rao bound (CRB), were derived under the assumption that the parameter space is a vector space. However, in most real-world applications, the parameter space is in fact a nonlinear Riemannian space. It is thus of interest to have the CRB analogue for manifolds. (b) In statistical signal processing, it is of primary importance to possess simple models for describing stochastic processes, e.g. the auto-regressive (AR) process. However, most available models strongly rely on the underlying linear structure of the Euclidean space (allowing to "add" points, etc). They are inadequate for real-world applications involving nonlinear observation spaces (e.g. the sphere) - the field of directional statistics is filled with examples. A generalization of existing time-series

models to manifolds is thus needed. Regarding particular applications to be covered, representative examples are: (a) computation of means and (b) optimization of nonsmooth functions on manifolds. (a) Centroid computation in a Riemannian manifold finds direct applications in medical image, blind source separation, etc. Existing techniques are gradient-based and hence exhibit only a linear convergence rate. In this project, we study Newton-like algorithms to achieve a faster, quadratic rate. (b) Minimization of a nonsmooth functions on a manifold is required in many applications, e.g., construction of space-time codebooks in wireless systems [25]. Efficient solutions require the extension of standard Euclidean methods (e.g., bundle approach) to Riemannian manifolds. Manifold issues also arise in unconstrained nonsmooth optimisation, e.g. total-variation methods for image restoration, via the active set approach.

Research Areas: Signal Processing, Riemannian Geometry, Nonsmooth Optimization

Laboratories: Signal and Image Processing Lab

Initiated: Oct. 2007

Expected conclusion: Sept. 2010

Classification: PTDC/EEA-ACR/73749/2006



Project name: UBOAT – Ultra-Wide Band Transmission for Ad Hoc Networks

Project leader within ISR: Prof. Rui Dinis (UNL/ISR)

Project description: The implementation choices of very high data rate ad hoc networks for short and medium ranges, covering the physical, medium access control (MAC) and network layer are broad. Several proposals exist which use crosslayering techniques for the MAC and physical layers, but so far few proposed deeper cross-layering covering the three layers, and above. However, some optimizations, essential for the network and application layer performance, can only be achieved through this deeper integration.

Nodes must self-organize to control network access and reduce interference. Access can be organized into structured PANs (Personal Area Networks) composed of stable groups (scatternet), each one with one master node (e.g. 802.15.3); or it can be unstructured and decentralized (e.g. DCF (Distributed Coordination Function) of 802.11) for ad hoc medium access. Although DCF's theoretical peak rate is high, the effective throughput available per user is much lower due to MAC inefficiency on sharing the channel and on carrying broadcast traffic. Nowadays, there is a strong interest in UWB (Ultra-Wide Band) transmission schemes for ad hoc networks. The UWB signals have huge bandwidths and small power spectral densities, even below the channel noise levels. Therefore, an UWB-based system can share the spectrum with several "narrow-band" systems with minimal performance degradation for them. Moreover, since the UWB schemes use spread spectrum techniques allowing very high processing gains (even for services with moderate or high data rates), they provide strong robustness against interferences, such as those associated to the multiple "narrow-band" signals sharing its bandwidth.

The impulse radio techniques are the most popular candidate for UWB transmission, typically employing selected pulse modulation schemes combined with TH-MA (Time-Hopping Multiple Access). This is especially due to the reduced implementation complexity of impulse radio, when compared with continuous-wave UWB options. However, since the spectral efficiencies achievable with impulse radio techniques are typically low, there is an increased interest on UWB systems employing continuous-wave techniques such as OFDM (Orthogonal Frequency Division Multiplexing), DS-CDMA (Direct Sequence Code Division Multiple Access) and MCCDMA (MultiCarrier CDMA).

This work considers transmission techniques for UWB-based ad hoc networks. Both impulse radio, combined with TH-MA, and continuous-wave schemes, namely OFDM, DS-CDMA and MC-CDMA schemes, will be

considered for the UWB radio transmission. Appropriate signal processing schemes will be developed and evaluated, for both the transmitter and the receiver, so as to improve the range/bitrate tradeoffs.

Improved receivers, with multipath and multiaccess interference cancellation, will be developed. The use of multiple-antenna systems to improve the performances and/or to increase the capacity will be considered. The synchronization and channel estimation requirements will be studied, as well as appropriate estimation methods, namely employing iterative detection/estimation procedures will be developed.

For both transmission techniques (impulse radio and continuous-wave) we will consider DS (Direct Sequence) spreading and CS (Code Spread) schemes, namely employing TCH codes (Tomlinson Cercas Hughes).

Since the system should be able to share the spectrum with present "narrow-band" systems, there is especial interest in the evaluation of the mutual interference levels, as well as the development of techniques to minimize these interferences. To reduce the interference levels, we will consider appropriate pulse/spectral shaping techniques, as well as interference cancellation schemes.

Medium access control was traditionally implemented independently of the physical layer. Contention based models rely on CSMA/CA (Carrier Sense Multiple Access/Collision Avoidance) access mode, enhanced with RTS (Request to Send) / CTS (Clear to Send) mechanism for reducing the hidden node collision problem for large packets. To improve throughput and quality of service, priority mechanism and frame aggregation mechanism were introduced. However, it is not possible to offer QoS guarantees without introducing effective reservation mechanisms for broadcast and point-to-point communication. This can be achieved by coordinating access on a self-organized network, or by introducing cross-layering reservation mechanisms possibly supported by the physical layer (e.g. codes, bandwidths, time slots). From the network layer point of view, the final performance is also related to the relative performance of the broadcast traffic, since most of the basic routing and service discovery services use it. Broadcast traffic is more sensible to collisions since it is not acknowledged at the MAC layer. Its performance can be improved using cross-layering approaches. In this project we intend to optimize the throughput at the network layer, through an evaluation of the study of relevant implementation choices and crosslayer implementations.

Research Areas: Ad hoc networks, UWB (Ultra-Wide Band Systems), Spread spectrum, Cross-layering optimization

Laboratories: Signal and Image Processing Lab

Project partners: ADETTI/ISCTE, UNINOVA

Initiated: Oct. 2007

Expected conclusion: Sept. 2010

Classification: PTDC/EEA-TEL/67066/2006



Project name: ESONET - European Sea Observatory Network

Project leader within ISR: Prof. Sérgio Jesus (UALG/ISR)



Project description: ESONET is an European Network of Excellence involving over 50 European institutions during 4 years with the aim of laying down the plans and necessary standards for a future network of land connected sites for ocean observation throughout Europe, from the North Sea to the west Mediterranean. This project is financed by the EU under FP6 programme, with 7.5 Meuros for 4 years.

URL: http://wwz.ifremer.fr/esonet_emso

Research Areas: ocean circulation, climate, biology, bio-acoustics, geophysics.

Laboratories: Signal and Image Processing Lab

Project partners: IFREMER (coordinator), ULB, IO-BAS, ALCATEL, ATLANTIDE - ALTRAN OUEST, CNRS, CNRS – LOV, CNRS – CEREGE, CNRS – CPPM, CNRS – IUEM, CNRS – LMGEM, IPGP, NKE, SERCEL, Océanopolis, KDM, IFM – GEOMAR, AWI, JUB, MPIMM, NSW, SEND, SIS, TFH Berlin, HCMR, FORTH, IMI, CSA, CNR – ISMAR, INFN, INGV, TECNOMARE, TESEO, FUGRO, NIOZ, UIT,NGI, NERSC, CINTAL, FFCUL, DOP-Uaç, UALG, CSIC, UPC, DBSCALE, UGOT, SU, B.U.,KOERI, DEU-IMST, ITU-EMCOL, GURALP SYSTEMS LTD, NERC-NOC, UNIABDN.

Initiated: March 2007

Expected conclusion: Feb. 2011

Classification: FP6-SUSTDEV SUSTDEV-3 Global change and ecosystems



Project name: UAN – Underwater Acoustic Network

Project leader within ISR: Prof. Sérgio Jesus (UALG/ISR) – project coordinator

Project description: UAN objective is to conceive, develop and test at sea an innovative wireless network integrating submerged, terrestrial and aerial sensors for the protection of off-shore and coastline critical infrastructures. This project is funded by EU under FP7 Collaborative project ICT/Security with 2.95 MEuro for 3 years.



URL: <http://www.siplab.fct.ualg.pt/proj/uan.shtml>

Research Areas: Underwater communications, infrastructure protection

Laboratories: Signal and Image Processing Lab

Project partners: CINTAL, SELEX, SINTEF, ISME, FOI, KM

Initiated: Oct. 2008

Expected conclusion: Sept. 2011

Classification: FP7 Collaborative project ICT/Security



Project name: OAE – Ocean Acoustic Exploration



Project leader within ISR: Prof. Sérgio Jesus (UALG/ISR) – project coordinator

Project description: OAE is an exchange project funded under the EU Marie-Curie initiative that aims at reinforcing links, exchanging experiences and methodologies between european and non-european partners in the field of ocean exploration using acoustics. This project is funded by EU under FP7 IRSES program with 187.2 kEuro for 3 years.

URL: <http://www.siplab.fct.ualg.pt/proj/oaex.shtml>

Research Areas: Collaboration, underwater acoustic monitoring and communications

Laboratories: Signal and Image Processing Lab

Project partners: CINTAL - Centro de Investigação Tecnológica do Algarve (beneficiary), ULB - Université Libre de Bruxelles (Belgium), COPPE - Universidade Federal do Rio de Janeiro (Brasil), IEAPM - Instituto de Estudos do Mar Almirante Paulo Moreira (Brasil) and C-MARS Canadian Marine Acoustic Remote Sensing Facility (UVic, Canada).

Initiated: Feb. 2009

Expected conclusion: Dec. 2011

Classification: FP7-PEOPLE-IRSES-2008 Marie Curie Action "International Research Staff Exchange Scheme"



Project name: PHITOM - Probabilistic High-Frequency Ocean Tomography for Underwater Communications and Navigation

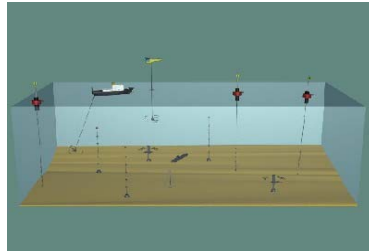

Project leader within ISR: Prof. João Pedro Gomes (IST/ISR)

Project description: the project aims at developing and applying techniques of ocean acoustic tomography to the high-frequency signals used in digital communications incorporating into the receiver some awareness of the environment and the spatial configuration of the acoustic link that is also current underwater modems. Having this capability built into the receiver is very appealing for a number of reasons.

URL: <http://www.siplab.fct.ualg.pt/proj/phitom.shtml>

Research Areas: high frequency propagation, underwater communications, bayesian methods.

Laboratories: Signal and Image Processing Lab

Project partners: Instituto Superior Técnico (P), CINTAL (P).

Initiated: Dec. 2007

Expected conclusion: Nov. 2010

Classification: PTDC/EEA-TEL/71263/2006

Project name: WEAM - Wave Energy Acoustic Monitoring

Project leader within ISR: Prof. Sérgio Jesus (UALG/ISR)



Project description: the project aims at developing, testing and validating a monitoring system for determining underwater acoustic noise generated by wave energy-based generators and its impact in the sea fauna of. This study will be able to extend noise predictions to farms of wave generators with pre-determined configurations.

URL: <http://www.siplab.fct.ualg.pt/proj/weam.shtml>

Research Areas: Acoustic environmental monitoring, acoustic tomography

Laboratories: Signal and Image Processing Lab

Project partners: Wave Energy Center, CINTAL:

Initiated: Nov. 2007

Expected conclusion: Oct. 2010

Classification: PTDC/ENR/70452/2006



Project name: CONTACT - Learning and Development of Contextual Action

Project leaders within ISR: Professor José Santos-Victor and
Professor Alexandre Bernardino (IST/ISR)

Project description: As infants, each one of us developed the ability to move our muscles to manipulate objects and also to communicate with gestures and speech. Did we learn to perceive and produce gestures for manipulation and speech independently, or are these two learning processes linked? The CONTACT project is an ambitious attempt to investigate the parallel development of manipulative and speech-related motor acts from a multi-disciplinary perspective. The project is designed to test the hypothesis that fundamentally similar mechanisms are involved in the development of perception and production for both speech and manipulation. This hypothesis is stimulated by recent evidence suggesting that the human brain interprets motor acts (movements) of other people in essentially the same way, regardless of whether the act generates speech or a manipulative gesture.

The work developed at IST during the first year of the project consisted on sound source localization for the iCub head. For that purpose, the robot head was equipped with two microphones. The binaural sound difference (intensity or phase) is used for localization on the horizontal plane. For the vertical plane, the proposed method was based on the design of ear shapes (*pinnae*) similar to some extent to the human ears so that notches at different sound frequencies can be used as cues for the (vertical) localization of the sound.

In the second year of the project, we developed an architecture that allows an artificial system to acquire language. Initially the system explores its own vocal track and builds audiomotor maps. Then, through the interaction with a caretaker the system learns basic sounds (e.g. phonemes) that can later on be used for communication.

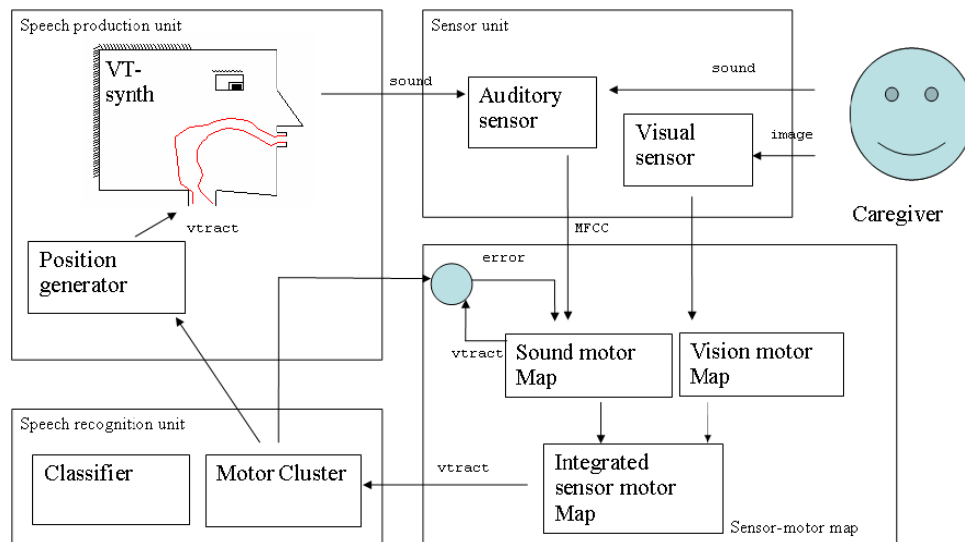

Research Areas: Computer Vision

Laboratories: Vislab - Computer Vision Lab

Project Partners: IST, DIST, U.Genova (I), Dpt Psychology U. Uppsala (SE); Dept Human Physiology, U. Ferrara (I); Dpt Linguistics, U. Stockholm (SE);

Initiated: Sep. 2005

Expected conclusion: Aug. 2009

Classification: NEST-5010



Project name: ROBOT-CUB - ROBotic Open-architecture Technology for Cognition, Understanding, and Behaviour

Project leaders within ISR: Profs. José Santos-Victor and Alexandre Bernardino (IST/ISR)



Project description: RobotCub is an Integrated Project funded by European Commission through the E5 Unit (Cognition) of Information Society Technologies priority of the Sixth Framework Programme. The consortium is initially composed of 11 European research centers plus two research centers in the USA and three in Japan specialized in robotics, neuroscience, and developmental psychology. The main goals of RobotCub are two: (1) to create an open robotic platform for embodied research that can be taken up and used by the research community at large to further their particular approach to the development of humanoid-based cognitive systems, and (2) to advance our understanding of several key issues in cognition by exploiting this platform in the investigation of cognitive capabilities. The scientific objective of RobotCub is, therefore, to jointly design the mindware and the hardware of a humanoid platform to be used to investigate human cognition and human-machine interaction. We call this platform CUB or Cognitive Universal Body. It is worth remarking that the results of RobotCub will be fully open and consequently licensed following a General Public (GP) license to the scientific community.



The team at IST is responsible for the design of the head of the iCub. The design specifications were based on the characteristics of the oculomotor system of children. This is the most complete robotic head for the given size. It consists of three degrees of freedom (dof) eye sub-system and a three dof neck. The eyes can verge

independently and tilt around a common axis. The neck can perform the pan-tilt-swing movements. The overall weight of the head is about 1.2Kg, motors included. All motors are equipped with encoders and the head possesses an inertial unit (the vestibular system). IST also worked on the design of the robot's face. The fact that the robot should act in a social environment to elicit communication with other robots and/or people was taken into account. The work on the face design was done in collaboration with the design company *Alma Design*. The picture below shows the designed head.

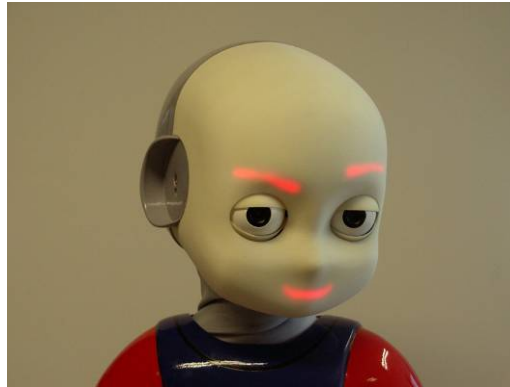

Research Areas: Computer Vision

Laboratories: Vislab - Computer Vision Lab

Project Partners: IST, DIST, U.Genova (I), Arts Lab SSS. Anna (I), AI Lab U. Zurich (CH); Dpt Psychology U. Uppsala (SE); Dept Human Physiology, U. Ferrara (I); U.Hertfordshire (UK); U. Salford (UK); EPFL (CH); Telerobot S.r.l. (I); European Brain Research Institute (I)

Initiated: Sep. 2004

Expected conclusion: Aug. 2009

Classification: IST-2004-004370



Project name: **GESTINTERACT** - Gesture Interpretation for the Analysis of Interactions Humans/Robots/Humans

Project leader within ISR: Prof. José Santos-Victor (IST/ISR)

Project description: When engaged in collaborative activities, people express their opinions, intents and wishes by speaking to each other using intonation, facial expressions and gestures. They move in physical space and manipulate objects. These actions are inherently linked to the individual's cognitive perception. They have a meaning and a purpose. They are adapted to both the environmental and social setting. In this project methods and techniques for the interpretation of human gestures will be developed using computer vision so that the analysis of the interaction and communication between humans and man-machine can be performed. The interaction will take place indoors. The space where the interaction occurs will be covered by a network of cameras. The techniques to be developed shall allow for the machine/robot to interpret human gestures from those with whom it interacts but also the interpretation of the interaction among humans using gestures and body posture.

Research Areas: Computer Vision

Laboratories: VisLab – Computer Vision Lab
Project Partners: ISR – Coimbra Pole
Initiated: Sept. 2005
Expected conclusion: Aug. 2008
Classification: FCT - POSI/EEA-SRI/61911/2004



Project name: VEMUCARV – Spatial validation of complex urban grids in virtual immersive environments

Project leader within ISR: Prof. Alexandre Bernardino (IST/ISR)

Project description: The main goals of this project are related to the semi-automatic acquisition and maintenance of 3D virtual reality models of urban areas. It is intended to use registered aerial images and low altitude laser range scans to acquire 3D data of city structure. This data will be processed in order to segment relevant structures for urban planning (buildings, roads, green areas, etc). Range information provides a very rich description of 3D structure but lack photometric information. Aerial photos provide this information, allowing to pre-segment regions based on color and texture. The main scientific innovation of this project is the combined use of 2D (aerial images) and 3D (range scans) to simplify and improve the building extraction process. Most current approaches use one or the other types of data exclusively. The final result provides a computer model which stands for a mix geometry-image database that can interface to GIS software available (at CML), as well as the generation of real-time walkthrough with thematic information. The results of this project are to be integrated on Lisbon City Hall public computational facilities.

Research Areas: Computer Vision, Virtual Reality, Computer Aided Design, Geographical Information Systems

Laboratories: VisLab – Computer Vision Lab

Project Partners: IDMEC-IST, CML

Initiated: May 2005

Expected conclusion: June 2008

Classification: POCTI/AUR/48123/2002



Project name: BIO-LOOK - Biomimetic Oculomotor Control for Humanoid Robots.

Project leader within ISR: Prof. Alexandre Bernardino (IST/ISR)

Project description: There is an increasing interest in advanced human-robot interfaces e.g. for "service robots" able to perform a variety of assistive tasks in human inhabited environments. Head and eye movements are particularly important for human-humanoid interaction, because they constitute a highly attended and communicative part of the human body, being able to convey emotions and express intentions and goals. On one hand, the way a robot controls its gaze toward targets may elicit different emotional interpretations by the user. Fast motions may indicate deep engagement on a task in time-critical or dangerous situations while smooth motions may indicate idleness and availability for interaction. On the other hand, the visual locations in which a robot concentrates its attention convey information about objects and spatial locations of interest to the current task, driving users' attention to the important items in the scene (sharing attention). By concentrating the direction of observation in particular objects or humans will indicate if the robot is enrolled in a well defined task or its intention to interact with the human. Both modalities

constitute basic implicit communication skills that will contribute to the development of advanced human-humanoid interfaces.

This project will address the following topics in oculomotor control: (i) how to perform human-like eye-head movements and postures while executing tasks and interacting with humans; (ii) how are oculomotor processes learned and developed through childhood; (iii) how can robot behaviour be modulated to implicitly communicate emotions, intentions and goals to human users. The studied methodologies will be implemented and tested both in realistic dynamical simulations and in prototype humanoid robotic platforms available in the consortium.

Research Areas: Computer Vision, Learning, Oculomotor Control

Laboratories: Vislab - Computer Vision Lab

Project Partners: University of Uppsala (Sweden)

Initiated: Oct. 2007

Expected conclusion: Sep. 2010

Classification: FCT - PTDC/EEA-ACR/71032/2006



Project name: MMCAAC - Modern Monte Carlo Algorithms for Computational Control

Project leader within ISR: Dr. Luis Montesano (IST/ISR)

Project description: Reasoning and making decisions under uncertainty appears in numerous applications ranging from standard process control (chemical process control) to robotics (designing robots exploring optimally their unknown environment), sensor networks and tracking (positioning optimally sensors so as to optimize the received information) or finance (option pricing). Such problems are also closely related to experimental design (clinical trials) and active learning (exploring intelligently massive multimedia databases for information retrieval). Despite the growing interest in such problems, there is currently no generic computational algorithm available for complex stochastic models. Closed form or exact solutions only exist for very simple models, as the linear Gaussian case and for discrete world problems. In order to deal with continuous spaces, researchers have proposed numerous approximations. Unfortunately, most of them still rely in Gaussian approximations or have been developed for very specific applications.

The objective of this project is to develop modern Monte Carlo methods to solve discrete time stochastic optimal control problems in both the fully and partially observed cases for nonlinear and/or non-Gaussian models. It aims to combine modern computational tools developed actively in statistics (Markov chain Monte Carlo, Sequential Monte Carlo aka Particle filters) to ideas developed in automatic control, operation research (gradient estimation) and reinforcement learning (value function and policy parameterization). The focus is in developing generic algorithms that can be applied in different domains and provide a unified framework for this type of problems.

Research Areas: Reasoning under uncertainty, Monte Carlo Algorithms, Partially Observed Markov Decision Processes, Robotics

Laboratories: Vislab - Computer Vision Lab

Project Partners: University of British Columbia (CA)

Initiated: Sept. 2007

Expected conclusion: Aug. 2010

Classification: FCT - PTDC/EEA-ACR/70174/2006

Project name: Smart Vision – An Active Vision Aid for the Blind

Project leader within ISR: Prof. Hans du Buf (UALG/ISR)

Project description: This project aims at developing a navigation system supported by GPS and GIS, supplemented by a vision system for obstacle avoidance, landmark detection and object recognition.

Research Areas: GIS/GPS, computer vision, human vision models

Laboratories: Signal and Image Processing Lab

Project partners: CINTAL, UTAD, AIBILI Coimbra, ISR Lisbon

Initiated: Jan. 2008

Expected conclusion: Dec. 2010

Classification: PTDC/EIA/73633/2006 (FCT)



Project name: Neural Correlates of Object Recognition: Structure-function Correlations within the Visual Ventral Stream, Striatal and Limbic Circuits in Health and Disease

Project leader within ISR: Prof. Hans du Buf (UALG/ISR)

Project description: Part of this project aims at developing models for Focus-of-Attention (psychophysics, eye-tracking) and a neural model of facial expression recognition.

Research Areas: human vision models, perception, psychophysics, fMRI

Laboratories: Signal and Image Processing Lab

Project partners: AIBILI Coimbra, Univ. Aveiro, CINTAL

Initiated: Oct. 2008

Expected conclusion: Sept. 2010

Classification: PTDC/PSI/67381/2006 (FCT)



Project name: Open Micro-Bio - A framework for computational simulation of cellular communities during BioProcess Engineering

Project leader within ISR: Prof. Agostinho Rosa (ISR/IST)

Project Description: This project is devoted to the development of High-End modeling strategies to describe the Saccharomyces colony dynamics based on individual cell models (ICM), using complex systems approaches. It is a software framework to simulate bioprocess engineering from the microscale to the macroscale levels, enabling to simulate biotechnological processes with great detail. The software framework is to be designed to simulate both colony dynamics under several scenarios, such as, production inside bio-reactors and growth in fermented foods, where the colony is highly affected by external factors such as fluid dynamics, chemical and biochemical reactions, nutrient diffusion and electromagnetic fields.

Open Source Bioinformatics

The large computational power necessary and model complexity, requires to use the latest legacy computational technology, both hardware and software; as well as programming and system development technologies, such as the use of GPU workstations and GRID computing. The project is Open Source! We hope to collaborate with you soon.

OpenMicroBio Microscale Apparatus

The project uses also the latest legacy technology in experimental apparatus. Experiments will comprise the use of batch/continuous bio-reactors, filming cellular growth and interactions at the microscope, using spectroscopy for determining nutrient diffusion and chemical/biochemical reactions. Furthermore, this project will use the latest developments in technometry for data analysis, in order to interpret and develop the individual cell models and 'emergent' microscale-to-macroscale cellular automata models.

People Involved

The project will involve highly qualified theoretical programmers and systems engineers, as well as experimental scientists; all from CBMA-UM (Molecular and Environmental Biology Research Center) CEB-UM (Centre of Biological Engineering – University of Minho) and LaSEEB-ISR (Laboratory of Evolutionary Systems and Biomedical Engineering Lab – Institute of Systems and Robotics, Lisbon).

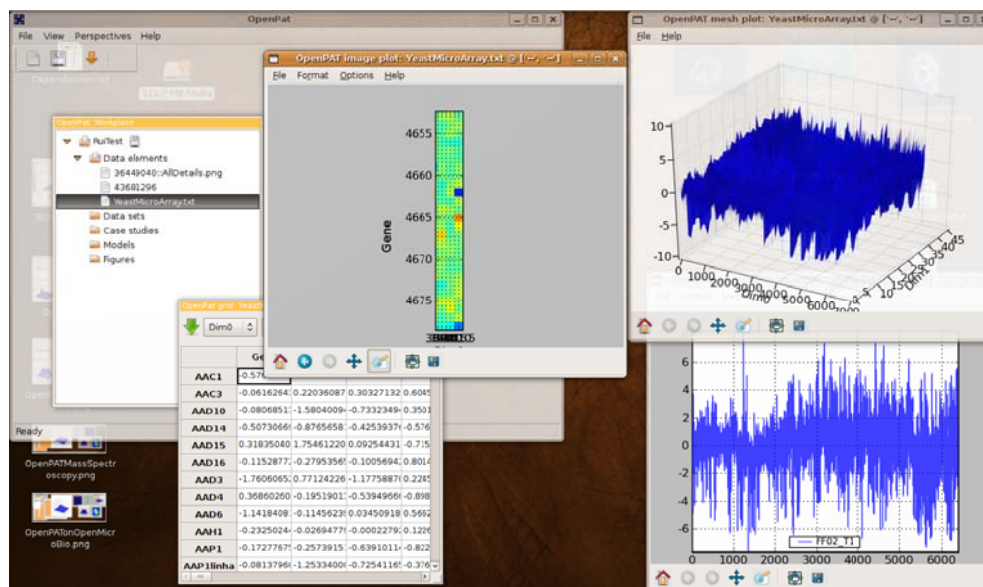

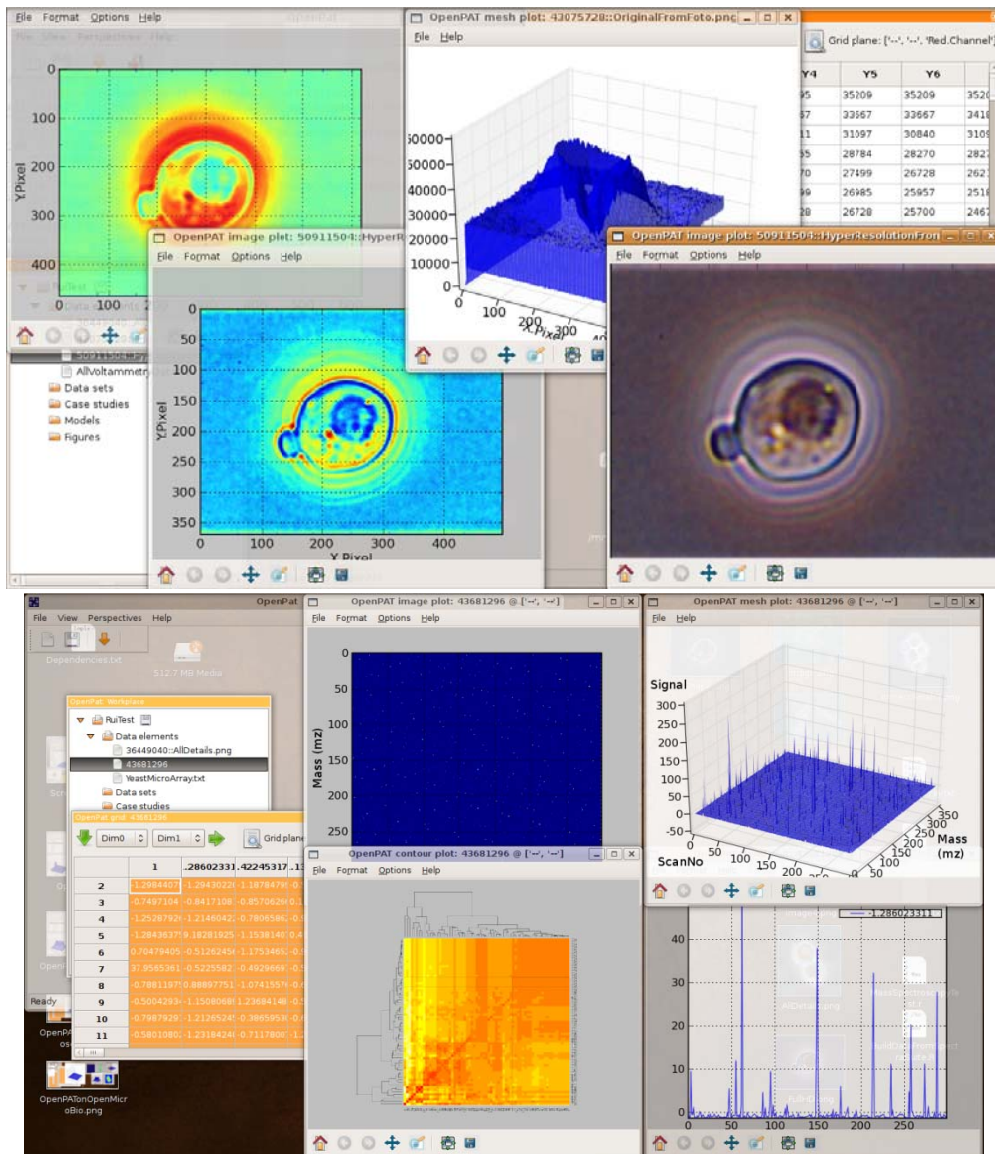

OpenMicroBio Project

Task: GPU implementation of an Agent Simulation Framework

Agent-Based Modeling (ABM) is a methodology used to model complex dynamic systems, such as stock markets, societies and biological systems, which are difficult to model analytically using partial differential equations. This is particularly the case where the system consists of autonomous entities who can independently act based on their goals and evolve over time. The properties of the system as a whole emerge from micro-scale interactions between entities and the environment. Such is the case of biological systems at the cellular level, where ABM provides a way to represent the true diversity of existing entities and related non-linear interactions. ABM also allows the possibility of determining behavioral distribution (not just the average) and rapid insertion/removal of entities and interactions. ABM formalism frameworks now provide the necessary structural and organizational context present in differential equation modeling.

There are two main problems with ABM: a) it requires considerable computational power to simulate individual entities; and b) parameter tuning is not trivial. The last problem can be minimized with computationally intensive parameter sweeping techniques; as such, both problems fall in the category of hefty computational requirements. This issue arises because population size is extremely important in ABM. By

nature, system level behaviors change with population size. In the case of the OpenMicroBio project populations in the order of millions of individuals are required to perform realistic simulations. Current generation ABM frameworks such as Repast, NetLogo and MASON, do not scale well for populations larger than a few thousand individuals. This is because of the serial nature of computing on the CPU.

OpenMicroBio aims to utilize the computational capabilities of the Graphics Processing Unit (GPU) to speed up large-scale ABM simulations of yeast colony and biofilm dynamic behavior. There are two factors that enable the scale and speed of ABMs that we want to achieve: a) computing power, and b) memory bandwidth. The latest generation NVIDIA GeForce GTX295 is rated at 1.788 teraflops, with a cost of approximately 500€. The top rated Intel 6-core Xeon (costing about 3.000€) has a peak performance of 63.84 gigaflops. Memory bandwidth of the GPU is also superior to that of the CPU: approximately an order of magnitude higher for the given example. However, to make full use of the available computing power and bandwidth, computation has to be restricted to the GPU, with minimal or no communication with the CPU; this is because GPU-CPU communication through the PCI Express bus is very slow when compared to data transfer within a single chip die. Add the fact that GPU computation is much more limited in scope than its CPU counterpart, and it is possible to conclude that the development of GPU-ABM simulations is a non-trivial task.

The GPU is what is called a stream processor, i.e. a processor which can operate in parallel by running a single kernel on many records in a stream at once. A stream is simply a set of records that require similar computation. Kernels are the functions that are applied to each element in the stream. Since GPUs process records independently there is no way to have shared or static data. For each element we can only read from the input, perform operations on it, and write to the output. It is permissible to have multiple inputs and multiple outputs, but never a piece of memory that is both readable and writable. Thus, efficient GPU applications should have large data sets, high parallelism, and minimal dependency between data elements.

A common form of feeding data to the GPU is by using a 2D grid data structure; this process fits naturally with the GPU rendering architecture. Many computations naturally map into grids: matrix algebra, image processing, physics simulation or cellular automata (CA) execution. Since textures are used as memory, texture lookups can be used as memory reads. This allows certain operations, such as the map operation, to be performed automatically. The map operation simply applies the given function (the kernel) to every element in the stream.

Considering the previous arguments, it is possible to set an essential requirement for the development of an efficient ABM-GPU framework: it should be based on a 2D explicitly discrete simulation environment, where each discrete block is an independent processing unit. This approach adapts well to the GPU programming premise, but nonetheless limits our modeling options. Thus, it becomes imperative to determine if it is possible to develop the proposed yeast models within a framework with such constraints. In order to perform such verification, we developed a prototype simulator which allows the development of models within the set limitations.

Preliminary results: LAIS

The prototype simulator, codenamed LAIS, runs on the CPU. However, LAIS emulates the constraints imposed by running simulations on the GPU: each block of 2D simulation environment is independent and can run in its own thread (fig. 1). The simulator is programmed in Java and uses scheduling and graphing tools from the Repast Agent Toolkit for rapid application development.

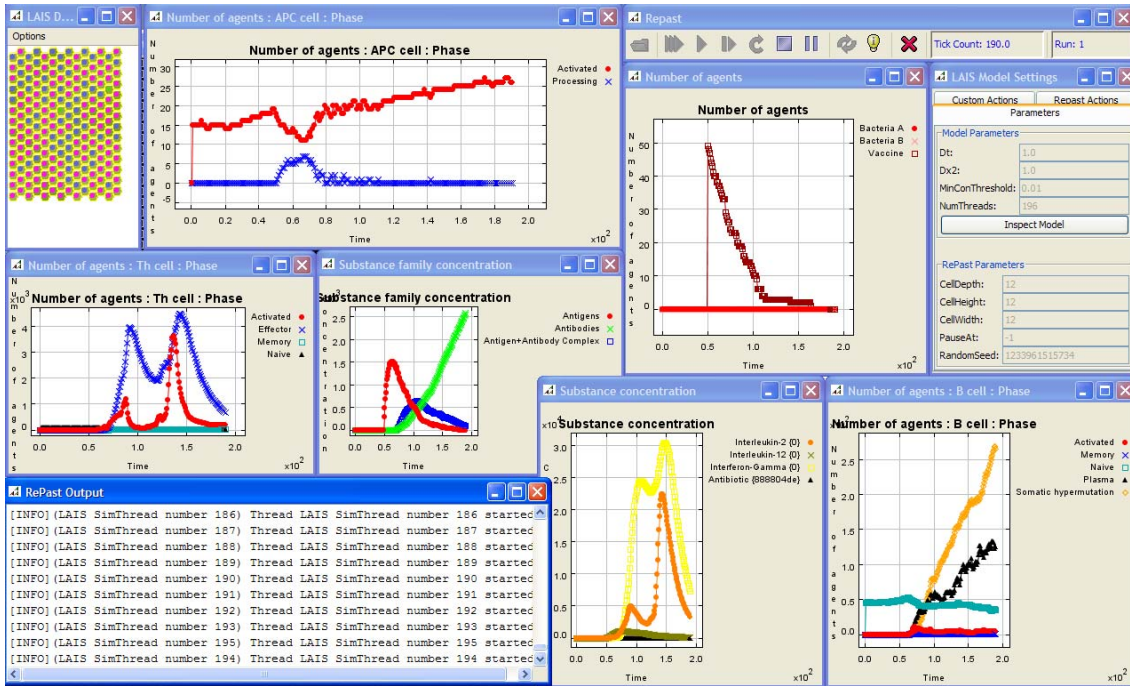

Figure 1 – The LAIS simulator

As required in general-purpose GPU computation (GPGPU), models developed on LAIS are discrete in space and time. Simulation space is divided in two layers. The lower layer, a specialized CA, is responsible for **substance** diffusion, reaction and degradation, while the upper layer represents the space where **agents** move and act. Communication between the two layers occurs when agents produce or consume substances, or when an agent action depends on the underlying substances. Substance concentration is real valued, and can be present in the lower layer of the model, or on the surface of agents. Substances are defined by bit strings. Agents communicate and act depending on the interaction of substances on the cellular surface and on the environment. Agents can present different substances at different times, contributing to a dynamic global behavior.

Research Areas: BioSystem Modelling and optimization

Laboratories: Evolutionary Systems and Biomedical Engineering Lab (LaSEEB)

Project partners: Instituto Superior Técnico (IST), Universidade do Minho (UM)

Initiated: 2007

Expected Conclusion: 2010

Classification: FCT PDCTE/BIO/69310/2006

2.2 POST-DOCS ACTIVITIES REPORT

2.2.1 Activity Report of Giampero Salvi

Period: January 2008 to December 2008

Fellowship: FCT - SFRH/BPD/35050/2007

Description of activities: The main activity during 2008 was performed within the scope of the CONTACT: Unsupervised learning of acoustic categories in speech - follow-up Dr. Salvi's Ph.D. work aiming at evaluating machine learning methods for inferring acoustic categories from the regularities that can be observed in speech data.

Analysis of a multichannel acoustic/articulatory speech database - During the CONTACT project, a multichannel speech database called Linguometer was recorded. Data include audio, video, ultrasound, articulograph and glottograph recordings for isolated words in Italian. The aim of the analysis is to find the mapping between articulatory movements of the tongue and the other speech organs, and the resulting acoustic signal. Dr. Salvi supervised the work of Michele Tavella during his visit to the Vislab at IST. The activity focused on fine tuning the raw data to prepare the database for the analysis, selecting the features that best described the problem, and using machine learning techniques to learn the mapping between acoustic and articulatory parameters.

Learning word/meaning associations - These studies make use of a humanoid robot with the aim of finding associations between the verbal description of manipulation experiments and the "conceptual" descriptions of the same experiments in terms of object properties, actions the robot performs and effects it observes. The assumption is that the associations between words and meanings can be obtained simply by considering co-occurrence, without the use of a grammar. The method involves speech recognition to translate the acoustic input to the robot into words and a probabilistic framework to find co-occurrence between words and meanings. Dr. Salvi co-supervised Verica Krunic during her thesis project on this subject.

Modeling imitation of acoustic patterns in infants - In the interaction with their parents, infants produce utterances that may or may not be considered as an imitation of the parent's utterance. Experiments with human judges show that we are fairly consistent in deciding if a vocalization is an imitation or not. The aim of this study in co-operation with Jonas Hörnstein and Lisa Gustavsson is to find the acoustic parameters that can be used to reproduce the same classification in an automatic manner.

Modeling the emergence of syllable inventories - Dr. Salvi participated in designing and implementing the simulations in [3]. This study tries to explain the distribution of features in the phonetic systems that are observed in real languages. Systems consisting of consonant-vowel syllables were considered. The place and manner dimensions were discretized resulting in 35 possible syllable kinds. Perceptual and articulatory constraints were estimated by performing listening tests on the set of possible syllables and by computing the articulatory cost in terms of energy based on x-ray measurements of the vocal tract. These constraints were used in simulations in different combinations in order to rank the most effective inventories of subsets of the 35 syllables. The size of the inventories was varied in the experiments. The results show that only when target learning is implemented in the simulations, the best systems show strong recombination of place features, as observed in real languages.

Results of previous work

During 2008, Dr. Salvi co-authored two papers [4,5] based on the results of studies performed during his Ph.D.

Teaching and Dissemination

In March 2008, Dr. Salvi was involved in the ATHENS course on learning robots, teaching unsupervised learning theory and techniques. The material created for the course was used ever since in the course. He was also involved in a number of presentations locally at Vislab and at other labs (e.g. the speech group at INESC-ID) in the attempt to promote cooperation. Finally, during 2008, he participated in two CONTACT project meetings in Munich (January 2008), and Uppsala (June 2008).

- [1] Kronic, V., Salvi, G., Bernardino, A., Montesano, L., & Santos-Victor, J. (2008). Associating word descriptions to learned manipulation task models. IEEE/RSJ Intl. Conf. on Intelligent Robots & Systems (IROS). Nice, France.
- [2] Kronic, V., Salvi, G., Bernardino, A., Montesano, L., & Santos-Victor, J. (2009). Affordance based word-to meaning association. In IEEE International Conference on Robotics and Automation (ICRA). Kobe, Japan.
- [3] Lindblom, B., Diehl, R., Park, S-H., & Salvi, G. (2008). (Re)use of place features in voiced stop systems: Role of phonetic constraints. In Proceedings of Fonetik 2008. University of Gothenburg.
- [4] Al Moubayed, S., Beskow, J., & Salvi, G. (2008). SynFace Phone Recognizer for Swedish Wideband and Narrowband Speech. In Proceedings of The 2nd Swedish Language Technology Conf. (SLTC). Stockholm, Sweden.
- [5] Beskow, J., Granström, B., Nordqvist, P., Al Moubayed, S., Salvi, G., Herzke, T., & Schulz, A. (2008). Hearing at Home – Communication support in home environments for hearing impaired persons. In Proceedings of Interspeech 2008. Brisbane, Australia.

2.2.2 Activity Report of Jacinto Nascimento

Period: January 2008 to December 2008

Fellowship: FCT - SFRH/BPD/9409/2002

Description of activities:

Project Coordinator: HEARTRACK - Segmentation and tracking of the human heart in 2D and 3D ultrasound data based on a principled combination of the top-down and bottom-up paradigms (PTDC/EEA-CRO/103462/2008).

Abstract: The segmentation and tracking of the heart in ultrasound sequences is a challenging problem, which is still unsolved, in its full generality despite recent advances in this area. The main difficulties concern the presence of complex motion patterns of the heart and the low quality of ultrasound data mainly due to speckle noise, edge dropout effect caused by motion, the presence of shadows produced by the dense muscles, and the low signal to noise ratio. Most of the proposed solutions follow two trends: 1) the use of deformable model trackers based on low-level image features (e.g., edges) and 2) pattern recognition methods based on high-level visual features, automatically learned with the objective to minimize the probability of recognition errors. In the literature, the deformable models are usually called bottom-up approaches, while pattern recognition models are known as top-down approaches. This project proposes a combination of the bottom-up and top-down approaches for solving the problem of segmenting and tracking the left ventricle (LV) of the heart in 2-D ultrasound data. This will allow a significant improvement of previous methods since we are combining edge and motion information from bottom-up with visual appearance models used in top-down. Comparing with bottom-up, we expect to obtain improved robustness in the case of edge drop out and rapid LV motion as well as an automatic procedure for contour initialization. Comparing with top-down we will obtain a significant improvement since we will use additional sources of information given by the heart

dynamic model and image edges. This approach will allow the reduction of the number of training images used in top-down, solving the major drawback of this class of techniques.

Papers in international journals

- [1] **J. M. Sanches, J. C. Nascimento, J. S. Marques**, "Multiplicative noise reduction for medical imaging using the Sylvester-Lyapunov equation", *IEEE Transactions on Image Processing*, vol. 17, no. 9, pp. 1522- 1539, Sep 2008.
- [2] **J. C. Nascimento, J. S. Marques**, "Robust Shape Tracking with Multiple Models in Ultrasound Images", *IEEE Transactions on Image Processing*, pp. 392-406, vol. 17, no. 3, March 2008.
- [3] **J. C. Nascimento, M. A. T. Figueiredo, J. S. Marques**, "Independent increment processes for human motion recognition", *International journal of Computer Vision and Image Understanding*, vol. 109, no. 2, pp. 126-138, February 2008.

Papers in international conferences

- [1] **M. Taiana, J. Santos, J. Gaspar, J. Nascimento, A. Bernardino, and P. Lima**, "Color 3D model-based tracking with arbitrary projection models", *Workshop on Omnidirectional Robot ision*, (OmniRobo-Vis2008) in conjunction with *International Conference on Simulation, Modeling, and Programming for Autonomous Robots (SIMPAN 2008)*, 2008.
- [2] **M. Tajana, J. Nascimento, J. Gaspar, A. Bernardino**, "Sample-Based 3D Tracking of Colored Objects: A Flexible Architecture", *Proc. of the British Machine Vision Conference - BMVC'08*, vol. 2, pp. 825-834, University of Leeds, Leeds, UK, Sep. 2008.
- [3] **J. Nascimento, J. Sanches**, "Total Variation with automatic hyper-parameter estimation", *30th International Conference of the IEEE Engineering in Medicine and Biology (EMBC 2008)*.
- [4] **J. Nascimento, J. Sanches**, "Ultrasound Imaging LV tracking with adaptive window size and automatic hyper-parameter estimation", *International Conference on Image Processing*, (ICIP 2008), pp. 553-556, San Diego, California, U.S.A.
- [5] **M. Silveira, J. Nascimento, J. S. Marques**, "Level Set Segmentation with Outlier Rejection", *International Conference on Image Processing*, (ICIP 2008), pp. 761-764, San Diego, California, U.S.A.
- [6] **J. Nascimento, M. A. T. Figueiredo, J. S. Marques**, "Unsupervised learning of motion patterns using generative models", *International Conference on Image Processing*, (ICIP 2008), pp. 1085-1088, San Diego, California, U.S.A.

2.2.3 Activity Report of Porfirio Silva

Period: January to December 2008

Fellowship: FCT SFRH/BPD/35862/2007

Description of Activities:

The "Institutional Robotics" work program has the overall aim of developing and implementing a new approach to the control of multiple robots' systems, which adds, to the biological inspiration, concepts from social sciences. It also intends to combine emerging mechanisms (unintended effects of aggregated individual actions) with deliberative capabilities of agents endowed with (imperfect) cognitive anticipation of their actions' effects.

A first phase of the work programme is to be implemented along three lines:

Line A: conceptual refinement (semesters 1 to 4);

Line B: implementation in simulation (semesters 3 and 4);
Line C: implementation on physical robots (semesters 5 and 6).

What follows refers to the first 12 months of work under this programme.

The objective of Semesters 1 and 2 (under Line A) was the refining of the overall concept of "Institutional Robotics", namely giving some operational content to the concept of "institutional environment". With this purpose an informal working group, with the regular participation of four PhDs, two doctoral students and a Master student, has contributed to frame this new approach within the more mature work already taking place at ISLab.

Two outcomes of this work are:

- **P. Silva, R. Ventura and P. Lima**, "Institutional Environments", in Jung, B., Michel, F., Ricci, A., e Petta, P., (eds.): From Agent Theory to Agent Implementation, Proceedings of Workshop AT2AI-6, AAMAS 2008 - 7th International Conference on Autonomous Agents and Multiagent Systems, Estoril, Portugal, 2008, pp. 157-164 (<http://www.ofai.at/research/agents/conf/at2ai6/papers/AT2AI6-working-notes.pdf>);
- **P. Silva and P. Lima**, "Instituição", in Revista de Comunicação e Linguagens (in press).

In order to improve the effective integration of this approach with the research activities already on development at ISLab:

- (a) One ISR grantee (with a Master degree) engaged in a case study to test some of the main concepts of Institutional Robotics, both in simulation and in real robots, trying at the same time the modeling of those concepts in UML (Unified Modeling Language);
- (b) A PhD student, advised by the scientific responsible for this post-doctoral fellowship, presented a work plan within the framework of institutional Robotics ("societies of robots");
- (c) One of the "Bolsas de Iniciação à Investigação" (BII) (undergraduate grants) of ISR will support an experiment on some institutional concepts within a virtual world;

A case study on institutional robotics concepts has started, both on real robots (eight e-pucks, <http://www.e-puck.org/>) and in realistic simulation ("realistic" in the sense that the same code is used in simulation and in real robots; see Webots, <http://www.cyberbotics.com/>). The case study deals with teams of robots acting as autonomous vehicles in an urban traffic scenario, eventually shared with humans, where we need the robots to recognize the physical as well as the normative constraints humans will tend to accept as "natural".

To strengthen the multidisciplinary nature of this work, a set of conferences was launched first in 2008 (from April 7 to July 7) to explore the topic "From Human Societies to Artificial Societies" (see details in "Special Events" section).

2.2.4 Activity Report of Vítor Vieira Lopes

Description of activities: The work developed during the Post-Doctoral program was greatly dedicated to the study in the fields of complex systems, object oriented programming techniques, statistical computing, GPU scientific computing applications and applied mathematics methodologies. The Post-Doctoral program was focus in the study of: a) complex system analysis - addressing issues like autonomy oriented programming techniques and statistical mean behavior analysis; and b) data analysis techniques for spectral signal decomposition and relevant data selection. With the OpenMicroBIO (PTDC/BIO/69310/2006) research project approval, it will be possible to look for these biological systems in more detail to understand the global

behaviour of biological systems processes. It will allow to combine multi-scale experimental data for the complex biological systems modeling and simulation. The participation on this project will allow to address two major pos-doctoral goals: a) data-driven methodologies for pattern recognition, image analysis and signal processing: relevant principal component analysis, PLS models, PARAFAC, supported vector machines and neural networks will be used to data mine all the information present in data. Information theory novel algorithms will be developed specially to understand and quantify synergistic/competitive interactions; and, b) understanding the emergence of the complex organization of colonies/biofilms from the interactions of its parts, individual cells and their environment, is the aim of the individual-based modeling (IbM) approach. Therefore, it will be possible to observe emergent behaviors, which can only be observed and well described by combining the different levels of information. Part of my post-doctoral research activities, also involved in the co-orientation of two MSc research work: a) a MSc research program is focused in the development of a platform for complex system simulation. The human immune system was selected as a case-study to demonstrate the simulator potentialities; and b) a MSc research program is focused in the modelling of a biological fermentation system for the optimization of Xylitol production

Scientific Publications and Communications

Book Chapter

R. C. Martins, V. V. Lopes, A. A. Vicente, and J. A. Teixeira, Chapter 1.4: Numerical solutions - finite element and finite volume methods. CRC Handbook on Optimization in Food Engineering, Ferruh Erdogdu (Ed.), In Press (2008).

Published Manuscripts

R. C. Martins, V. V. Lopes, P. Valentão, B. M. Silva, J. C. M. F. Carvalho, P. Amaral, M. T. Batista, M. R. Seabra, and P. B. Andrade. Relevant principal component analysis applied to the characterization of portuguese heather honey. Natural Product Research, accepted (2008).

R. C. Martins, V. V. Lopes, A. A. Vicente, and J. A. Teixeira, "Computational shelf-life dating: complex systems approaches to food quality and safety", *Food and Bioprocess Technology: An International Journal*, 1(3):207–222, 2008.

R. C. Martins, V. V. Lopes, "Modelling supercooling in frozen strawberries: Experimental analysis, cellular automation and inverse problem methodology", *Journal of Food Engineering*, 80: 126-141, 2008.

2.2.5 Activity Report of Ruben Martinez-Cantin

Dr. Ruben Martinez joined the ISR team at the end of 2008 after completing his doctoral thesis on Mobile Robotics at the University of Zaragoza, Spain. Previously, he spent three months at the lab as a guest researcher. During that time, he worked mainly in three different activities:

1. He started working in the projects currently being developed at the VISLAB, especially in the EU projects HANDLE and ROBOTCUB.
2. He continued and completed some of the research work started during his thesis which, based on the problem of Simultaneous Localization and Mapping (SLAM) and active strategies based on sequential decision making strategies.
3. He started a new research line in learning and decision making for humanoid robots. The objective of the line consist in extending theoretical front-end of the research conducted during the thesis, including some new applications to problems of efficient learning (e.g.: self-calibration of humanoid robots) using active strategies based on Information Theory.

His main research interests include Bayesian inference, sequential decision making, Monte Carlo methods, experimental design, robotics and neurosciences.

[1] A Bayesian exploration-exploitation approach for dynamic planning and mapping with mobile robots. Autonomous Robots, 2009 (Accepted).

[2] Active Body Schema Learning, Submitted to RSS 2009.

2.3 THESES

In this section the Doctoral and Master theses concluded, or in progress, during 2008 at ISR-Lisbon are identified.

2.3.1 Theses Concluded during 2008

DOCTORAL THESES (4)

Rodrigo Ventura, “Emotion-based Mechanisms for Decision Making in Autonomous Agents”, Ph.D. Thesis, Instituto Superior Técnico, Lisbon, Portugal, January 2008.

Abstract: Taking as biological inspiration the António Damásio proposal that the brain emotion mechanisms are essential for appropriate decision-making, this thesis presents a conceptual model for an autonomous agent based on a double-representation paradigm. Stimuli is represented under two distinct perspectives, thus inducing two representation schemata with different properties. The consequences of this model are explored in various forms. First, the applicability of the model to anticipation, and to the formulation of causal models about the world are explored. And second, a formal approach is presented, where theoretical consequences are derived, first from a probabilistic standpoint, followed by an approach based on the assumption that the above-mentioned representations live in metric spaces. Following this latter approach, an algorithm is proposed to adapt the metric for one of the spaces, as well as to provide guidance for the improvement of that representation, aiming at the creation of new features. The formulation of this algorithm is based on Multidimensional Scaling techniques. Results employing a synthetic world corroborate the hypotheses raised by the proposal of the algorithm.

Keywords: Emotions, Agents, Decision, Artificial Intelligence, Neuroscience.

Members of the Thesis Committee:

Helder Manuel Ferreira Coelho, Prof. Catedrático, Universidade de Lisboa (P)

Carlos Alberto Pinto-Ferreira, Prof. Associado, IST, supervisor (P)

Ana Maria Severino de Almeida e Paiva, Prof. Associado, IST (P)

Paolo Petta, PhD, University of Vienna (AT)

Luís Manuel Marques Custódio, Prof. Auxiliar, IST (P)

João Rodrigues, “Integrated multi-scale architecture of the cortex with application to computer vision”, Ph.D. Thesis, University of Algarve, Faro, Portugal, February 2008.

Abstract: The main goal of this thesis is to try to understand the functioning of the visual cortex through the development of computational models. In the input layer V1 of the visual cortex there are simple, complex and

endstopped cells. These provide a multi-scale representation of objects and scene in terms of lines, edges and keypoints. In this thesis we combine recent progress concerning the development of computational models of these and other cells with processes in higher cortical areas V2 and V4 etc. Three pertinent challenges are discussed: (i) object recognition embedded in a cortical architecture; (ii) brightness perception, and (iii) painterly rendering based on human vision. Specific aspects are Focus-of-Attention by means of keypoint-based saliency maps, the dynamic routing of features from V1 through higher cortical areas in order to obtain translation, rotation and size invariance, and the construction of normalized object templates with canonical views in visual memory. Our simulations show that the multi-scale representations can be integrated into a cortical architecture in order to model subsequent processing steps: from segregation, via different categorization levels, until final object recognition is obtained. As for real cortical processing, the system starts with coarse-scale information, refines categorization by using medium-scale information, and employs all scales in recognition. We also show that a 2D brightness model can be based on the multi-scale symbolic representation of lines and edges, with an additional low-pass channel and nonlinear amplitude transfer functions, such that object recognition and brightness perception are combined processes based on the same information. The brightness model can predict many different effects such as Mach bands, grating induction, the Craik-O'Brien-Cornsweet illusion and brightness induction, i.e. the opposite effects of assimilation (White effect) and simultaneous brightness contrast. Finally, a novel application is introduced: painterly rendering has been linked to computer vision, but we propose to link it to human vision because perception and painting are two processes which are strongly interwoven.

Keywords: Visual cortex, Focus-of-Attention, categorization, recognition, brightness, rendering.

Members of the Thesis Committee:

Hans du Buf, Supervisor, UAlg/ISR (P).

Rolf Wuertz, Institut fuer Neuroinformatik, Univ. Bochum (G).

Gustavo Deco, Univ. Pompeia Fabra, Barcelona (E).

Miguel Castelo-Branco, AIBILI, Univ. Coimbra (P).

Hamid Shahbazkia, UAlg (P).

Aurelio Campilho, Univ. Porto (P).

Alexandra Reis, UAlg (P).

Pedro Guerreiro, Ualg (P).

<p>Marko Beko, "Non-Coherent Communication in Multiple-Antenna Systems: Receiver Design, Codebook Construction and Capacity Analysis", Ph.D. Thesis, Instituto Superior Técnico, Lisboa, Portugal, February 2008.</p>

Abstract: The thesis addresses the problem of space-time codebook design for communication in multiple-input multiple-output (MIMO) wireless systems. The realistic and challenging non-coherent setup (channel state information is absent at the receiver) is considered. A generalized likelihood ratio test (GLRT)-like detector is assumed at the receiver and contrary to most existing approaches, an arbitrary correlation structure is allowed for the additive Gaussian observation noise. A theoretical analysis of the probability of error is derived, for both the high and low signal-to-noise ratio (SNR) regimes. This leads to a codebook design criterion which shows that optimal codebooks correspond to optimal packings in a Cartesian product of projective spaces. The actual construction of the codebooks involves solving a high-dimensional, nonlinear, nonsmooth optimization problem which is tackled here in two phases: a convex semi-definite programming (SDP) relaxation furnishes an initial point which is then refined by an iterative subgradient-like geodesic descent algorithm exploiting the Riemannian geometry imposed by the power constraints on the space-time codewords. New codebooks are obtained by this method and their performance is shown to outperform

previous state-of-art solutions. In fact, for some particular configurations, these new constellations attain the Rankin bound and are therefore provably optimal. The thesis also contains new theoretical results on the capacity (mutual information) of multiple-antenna wireless links in the low SNR regime. The impact of channel and noise correlation on the mutual information is obtained for the on-off and Gaussian signaling. The main conclusion is that mutual information is maximized when both transmit and receive antennas are fully correlated.

Keywords: Multiple-input multiple-output (MIMO) systems, non-coherent communications, space-time constellations, Grassmannian packings, equiangular tight frame (ETF), channel capacity.

Members of the Thesis Committee:

Jean-Claude Belfiore, ENST (FR)

Paulo Jorge dos Santos Gonçalves Ferreira, IEETA, UA (P)

José Manuel Nunes Leitão, IST (P)

Victor Alberto Neves Barroso, IST (P)

Tim Davidson, McMaster University (CA)

João Manuel de Freitas Xavier, IST (P)

Plinio Moreno López, “Object component models using Gabor filters for visual recognition”, Ph.D. Thesis, Instituto Superior Técnico, Lisbon, Portugal, September 2008.

Abstract: The primate visual system is extremely successful and efficient in the challenging task of recognizing objects in complex scenes. A key component of the primate visual system is a massive utilization of neuronal circuits located in the low-level visual cortex areas, with responses similar to Gabor functions. These functions have important properties for image analysis such as selectivity to orientation, scale and frequency and being specially suited to characterize image texture.

In this thesis we explore the properties of Gabor functions in the context of component based object recognition. Current component-based object recognition approaches represent objects as constellation of sub-parts, dividing the problem in three stages: interest region selection, image region description and, eventually, the recognition step. We introduce novel methods using Gabor filters for interest point selection and image region description. Performance is evaluated with state-of-the-art object recognition architectures.

Regarding the selection of interest points, we define a new top-down saliency function. We encode the appearance of object components in terms of Gabor filter responses to build the saliency function. This saliency function computes a wavelength profile for every component, being effective in filtering out clutter and noisy features. The aim of this function is to reduce the number of candidates for posterior analysis, but maintaining high recall rates.

Once the points of interest have been detected, we propose region descriptors with rich and efficient matching representations that explore the full set of parameters of Gabor filters. Local maxima of the filter energy-response are the criterion adopted to define two types of descriptors: a feature vector formed by Gabor filter responses that are chosen specifically for each object component and an alternative way to compute the SIFT descriptor.

We perform extensive tests in real scenarios, to show experimentally that our models for interest point selection and local descriptor computation are well suited for component-based object recognition. Results

show that approaches based on Gabor filter responses outperform state-of-the-art approaches in several aspects of the object recognition problem.

Keywords: object recognition, Gabor filters, top-down saliency, component recognition, local descriptor, parameter selection

Members of the thesis committee:

Alberto Sanfeliu Cortés, Universidade Politécnica da Catalunha, Spain, (ES)

Aurélio Joaquim de Castro Campilho, University of Porto, (P).

José Santos Víctor, IST, supervisor, (P).

Mário Alexandre Teles de Figueiredo, IST, (P)

Fabrizio Smeraldi, Queen Mary College, University of London, (UK)

Alexandre José Malheiro Bernardino, IST, co-supervisor, (P).

MASTER THESES (38)

<p>Ricardo Daniel Rita Beira, “Mechanical Design of an Anthropomorphic Robot Head,” M.Sc. Thesis, Instituto Superior Técnico, January 2008</p>

Abstract:

This Thesis’s main objective was to develop an anthropomorphic robot head, composed by a neck and a vision system, using computational and analytical tools for its mechanical design.

The work was developed in the framework of the European Project RobotCub which is one of the biggest efforts to develop the capacities of perception and reasoning of robots. It integrates research groups of engineers as well as teams of psychology, medicine and neuroscience aiming to create robots can be able to develop their own perceptual, motor and cognitive capacities along the time, similar to the development of children or rear-born, thus allowing to test the underlying principles of these biological mechanisms. The final platform, the iCUB, is approximately 90 cm tall, with 23 kg and with a total number of 53 degrees of freedom.

So, as this robot head was designed to have similar properties of a two-year-old child’s head, some specifications were based, not only on the other different solutions, used in several humanoid robots, but also on the biological system anatomical and behavioral data.

In the end, a platform prototype was produced, tested and optimized, in order to increase its mechanical performances.

Keywords:

Humanoid Robots; Biologically Inspired Robots; Mechanical Design; Dynamic Analysis; Actuators Selection; Robotic Mechanisms; Visual-motor coordination

Members of Committee:

José Santos Víctor, IST (P), (supervisor)

Hélder de Jesus Araújo, Univ. Coimbra (P)

Alexandre Bernardino, IST (P)

Arlindo Silva, IST (P)

Pedro Viçoso Fazenda, “Non-Holonomic Robot Formations with Obstacle Compliant Geometry”, M.Sc. Thesis, Instituto Superior Técnico, Lisbon, Portugal, January 2008.

Abstract:

This thesis introduces a method to control a formation of holonomic or non-holonomic vehicles with a deformable geometry, compliant with nearby obstacles (including those represented by each robot team-mates). The vehicles are virtually linked to each other by the influence of artificial potentials that asymptotically stabilize the formation and keep all the robots separated by specified distances. A leader selected from the team, or a virtual reference point, is used to guide the team of autonomous vehicles throughout an area scattered with obstacles. Each vehicle has access to the positions of all its team-mates, and senses the obstacles within a limited range of its neighbourhood. All robots attempt to maintain the specified distances to the leader and every other member of the formation, as the result of attractive and repulsive forces. The forces are the negative gradients of the potential fields that interconnect the formation vehicles. The procedure guarantees the cohesion of the formation without collisions between the participating members. To avoid collisions with obstacles, the vehicles are subjected to extra repulsive potentials, which induce problems due to local minima. To avoid getting stuck in those points, each vehicle recalls the n latest positions of the leader and uses this information to move around the obstacle and stay in formation.

Keywords: Formation Control, Potential Fields, Obstacle Avoidance, Distributed Robotics, Cooperative Robotics, Multi-Robot Systems

Members of the Thesis Committee:

Maria Isabel Lobato Faria Ribeiro, Full Professor, IST (P)

Estela Bicho, Assistant Professor, U. Minho (P)

Pedro Lima, Associate Professor, supervisor, IST (P)

André Bianchi de Aguiar Araújo Figueiredo, “Sistema de Controlo de um Veículo Autónomo Aéreo”, MSc. Thesis, Instituto Superior Técnico, Lisbon, Portugal, January 2008.

Abstract:

The area of unmanned aerial vehicle (UAV) research has shown rapid development in recent years and offers a great number of research challenges for autonomous systems. In this work, a prototype architecture for UAV is presented, which supports the development of intelligent capabilities and their integration in the architecture. A hierarchical architecture is considered, and a hybrid systems framework was adopted in order to design control algorithms. The global control design relies on the concept of maneuver, which is modeled by a hybrid automata.

A simulation environment with “hardware-in-the-loop” characteristics has been created in order to validate the architecture. Experiments were performed both in simulated and real environments.

Keywords: Unmanned Aerial Vehicles, Hybrid Control, Hierarchical Control

Members of the Thesis Committee:

Jorge Manuel Miranda Dias, Associate Professor, Faculdade de Ciências e Tecnologia da Universidade de Coimbra (P)

João da Silva Sequeira, Assistant Professor, IST (P)

Eduardo Alexandre Pereira da Silva, Adjoint Professor, supervisor, ISEP/IPP (P)

Pedro Lima, Associate Professor, co-supervisor, IST (P)

Nuno Maria Carvalho Pereira Fernandes Fachada, "Agent-based Simulation of the Immune System", MSc. Thesis, Instituto Superior Técnico, Lisbon, Portugal, June 2008.

Abstract: Computational models of the immune system have several applications, such as theory testing and validation, or as a complement to first stages of drug testing. The majority of existing models are developed using formal methods based on differential equations, which generally assume the relevant immune agents are uniformly distributed in space. Although well formalized, this approach is far from intuitive and inflexible to change, often straying from biologic significance. Agent-based modeling is closer to biologic reality, as well as being a more pliable approach when it is necessary to add or remove model features.

In this thesis we present LAIS, an agent-based model of immune system dynamics. The discussion of methodologies used in existing models, and how these map on to plausible simulations, both from a biological and computational point of view, partly determined the characteristics of presented model. However, LAIS also presents novel features, such as flexible and modular modeling approach, multithreaded simulation engine, low level cellular receptor interaction simulation focus, among others. Studies and results regard antibody properties, immune memory and viral dynamics, and are in qualitative accordance with literature.

Keywords:

Modeling, Simulation, Agents, Immune System, Influenza

Members of the Thesis Committee:

Doutor Luis Miguel Parreira e Correia

Doutor António Manuel Raminhos Cordeiro Grilo

Pedro Daniel Correia Pires, "Activity Characterization from Actimetry Sensor Data for Sleep Disorders Diagnosis", M.Sc. Thesis, Instituto Superior Técnico, Lisbon, Portugal, September 2008.

Abstract: The human activity (HA) is one of the most important indicators used in assessing the sleep/vigil state and to estimate the sleep circadian cycle. Its accurate definition and measurement is very difficult.

Usually only an indirect and noisy version is available, acquired with an actigraph, that is a device mainly composed by a three axis accelerometer.

In this thesis the actigraph signal is statistically processed and considered as a noisy observation of the unknown variable Activity (ACT). The activity signal is correlated with the data from a sleep e-diary (SeD) to estimate the sleep/vigil state and identify abnormal patterns on its circadian cycle. In the scope of this work a SeD was developed in a mobile phone to make it easier for patients to register the more relevant events in their daily routine.

The main goal of this thesis is to define the HA and to propose a method to estimate it from the actigraph data and from the SeD.

An observation model for the actigraph signal is proposed based on the physical working principles of the acquisition device. A Bayesian approach is used to estimate the activity and a segmentation algorithm based on Graph-Cuts is used to infer the sleep/vigil (SV) state.

Experiments using real data have shown two distinct statistical distributions of the actigraph signal, one space-shifted Maxwell distribution during the wake time, and a space-shifted Poisson distribution during the sleep time. The estimated activity and SV state are consistent with the SeD data.

Keywords: Statistical Signal Processing, Human Activity, Actigraphy, Sleep Disorder, Sleep Diary, Distribution Mixture.

Members of the Thesis Committee:

Prof. Lopes da Silva

Prof. João Sanches, advisor, IST (P)

Prof. Dr. Teresa Paiva, advisor, FML (P)

Prof. Jorge Marques, IST (P)

Isabela Maria Montenegro da Silva, “Toward a fully automatic left ventricle segmentation using cine-MR images”, M.Sc. Thesis, Instituto Superior Técnico, Lisbon, Portugal, September 2008.

Abstract: Left ventricle (LV) function is assessed by manually segmenting SA cardiac cine-MR images. It is a labor, time-consuming, operator biased task. A series of difficulties arise from these images, that make automatic segmentation of the LV a challenging task: (i) misalignment of the LV along the stack, (ii) signal intensity variation over the stack and over the slice and (iii) the presence papillary muscle. In this thesis, the first steps toward a full automatic LV segmentation algorithm based on a single view of the LV are presented:

1. Automatic crop: selects a sub-volume containing the LV in all images and in all temporal frames from the acquired data. It is based on three assumptions: (i) the LV is close of the center of the image, (ii) the LV is circular shaped and (iii) there is a high temporal variability of the image intensity in the myocardium boundaries due the heart beating.
2. Alignment-by-reconstruction: novel technique to solve the misalignment due to respiratory motion, inspired on the work from Sanches et. al [1] in ultrasound;
3. Segmentation: The LV is segmented using active contours in an energy minimization formulation with GVF as external field. The automatic initialization algorithm here implemented is original, and it is based on the property of intersecting chords. Preliminary tests with synthetic and real data from 17 patients were performed with successful results.

Keywords: left ventricle, automatic crop, intra-plane alignment, snake initialization.

Members of the Thesis Committee:

Prof. Patrícia Figueiredo

Prof. João Miguel Raposo Sanches, advisor, IST (P)

Prof. Ana Maria Gomes de Almeida, advisor, FML (P)

Dr. Jacinto Carlos Marques Peixoto do Nascimento, ISR/IST (P)

José Santos, “A Baroreflex Control Model Using Head-Up Tilt Test”, M.Sc. Thesis, Instituto Superior Técnico, Lisbon, Portugal, September 2008.

Abstract: The searching for mathematical models to resemble the baroreflex mechanism is an active field of research because not all knowledge as been acquired yet. The researchers tried to decompose and analyse each effector in the whole pathway and insight has been slowly gained. A major problem present since the beginning was the impossibility in carrying tests in human subjects, which lead to the usage of animal subjects. This impossibility has led to an increase search of models that simulate not only this mechanism but also several others that are correlated with the baroreflex. The inexistence of a mathematical model that provides a valid explanation and a reasonable behaviour when compared to the baroreflex is a major gap.

Such a mechanism would fit perfectly in carrying several tests that are unavailable in the current medical practice. Further insight could also be acquired and open new possibilities such as drug testing and finding out more about the etiology of some pathologies.

The baroreflex is a control system with a negative feedback that exists to control the blood pressure values, meaning that it can be thought as a closed-loop system with multiple blocks representing the major physiological variables. Control theory and separation of effectors through blocks have been studied in the latest years with the development of some models to assess several observed characteristics (Ringwood & Malpas, 2001; Kawada, et al., 2002).

In this thesis, a model using control theory was built for the baroreflex and simulations were run in order to show its proper functioning when a disturbance affects the signal. The intention was to modulate the autonomic nervous system influence in the baroreflex and how this influence is felt and changes the heart rate and arterial pressure. For this, it was necessary to modulate each part of this system to try to achieve a stable and reasonable output signal. The model described in the next chapters is an incremental model which means that only signal variations are accounted (variation of sympathetic and parasympathetic innervation, for example). The tests were carried out by introducing the head-up tilt table test as the disturbance signal in the mean arterial pressure and by checking out how the system answers to this disturbance and watching carefully the evolution of mean arterial pressure (MAP) and heart rate (HR). The model was based in physiological knowledge and introduces some new features to the existing models.

The results show the expected behaviour when a blood pressure drop is felt by the baroreceptors and caused by the tilting table. Mean arterial pressure values recover to the initial values in the expected time window while the heart rate does not perform a full recovery because of the increase of the differential pressure in the whole body. The same happens with the cardiac output because it is influenced primarily by the heart rate. By changing parameters one can adjust the model to perform in a different way. The tests carried out all gave results that were the expected ones according to the changes introduced.

Keywords: Autonomic nervous system, model, baroreflex, baroreceptors, mean arterial pressure, heart rate.

Members of the Thesis Committee:

Prof. Lopes da Silva

Prof. João Miguel Raposo Sanches, advisor, IST (P)

Prof. Isabel Rocha, advisor, IMM/FMUL (P)

Profa Adélia da Costa Sequeira dos Ramos

Joana Coelho, "Joint Detection-Estimation of Brain Activity in fMRI using Graph Cuts", M.Sc. Thesis, Instituto Superior Técnico, Lisbon, Portugal, September 2008.

Abstract: The BOLD technique is an fMRI method that allows the detection of brain activated regions after application of an external stimulus. This technique is based on the assumption that the metabolism increases in activated areas as well as the oxygen uptake. Analysing this information is a challenging problem because the BOLD signal is very noisy and the task-related signal changes are small in amplitude.

Therefore, the detection of temporal correlations with the applied stimulus requires statistical algorithms to understand if the changes on the BOLD signal are related with the applied stimulus. The traditional approach needs the tuning of a parameter by a medical doctor which makes it impossible to be completely automatic.

In this thesis, a new Bayesian parameter-free method to detect brain activated areas in fMRI is described. The traditional estimation and inference steps are joint together and the neural activity detection, characterised by binary variables, is obtained simultaneously with an hemodynamic response function (HRF) estimation and a drift removal processing. Finally, a spatial correlation step with Graph Cuts is introduced to improve the detection of brain activity. This approach brings several advantages since the activity detection is performed iteratively, benefiting from the adaptive HRF estimation and drift removal. Moreover, the proposed method succeeds in providing local, space variant HRF estimation, an important physiologic characteristic.

Synthetic Monte Carlo tests are performed demonstrating the robustness of the algorithm. Finally, examples using real data are presented and compared with some results from the SPM-GLM.

Keywords: fMRI, Bayesian Models, Activation Detection, Hemodynamic Response, Spatial Correlation, Drift Removal.

Members of the Thesis Committee:

Prof. Patrícia Margarida Piedade Figueiredo
Prof. João Miguel Raposo Sanches, advisor, IST (P)
Prof. Martin Hagen Lauterbac, advisor, FML (P)
Prof. Mário Alexandre Teles de Figueiredo

José J. Rodrigues, “ANSIG - an Analytic Signature for Permutation Invariant Shape Representation”, M.Sc. Thesis, Instituto Superior Técnico, Lisbon, Portugal, September 2008.

Abstract: Many applications require a computer representation of 2D shape, usually described by a set of points. The challenge of this representation is that, besides capturing the shape characteristics, it must be invariant to relevant transformations. Invariance to geometric transformations was addressed in the past under the assumption that the points are labeled, i.e., that the shape is characterized by an ordered set of landmarks. However, in many practical scenarios the points are obtained from an automatic process, e.g., edge detection, thus without natural ordering. Obviously, the combinatorial problem of computing the correspondences between the points of two shapes becomes a quagmire when the number of points is large. We avoid this problem by representing shapes in a way that is invariant to the permutation of the landmarks. We map a shape to an analytic function on the complex plane, leading to what we call its analytic signature (ANSIG). We show that different shapes lead to different ANSIGs but that shapes that differ by a permutation of the landmarks lead to the same ANSIG. Thus, ANSIG is a maximal invariant with respect to the permutation group. To store an ANSIG, it suffices to sample it along a closed contour. We further show how easy it is to factor out geometric transformations when comparing shapes. We developed a shape-based image classification system, composed by a webcam and a Matlab software package, based on the ANSIG. Our experiments illustrate the performance of this system on automatic trademark retrieval and object recognition.

Keywords: 2D shape representation, shape recognition, automatic trademark retrieval, object recognition, analytic signature (ANSIG), shape-based classification.

Members of the Thesis Committee:

Prof. Carlos J. Silvestre, IST (P)
Prof. Mário A. T. Figueiredo, IST (P)
Prof. Pedro M. Q. Aguiar, IST (P)
Prof. João M. F. Xavier, IST (P)

David Jerónimo, “Passarola: Dirigível Autónomo para Operações de Salvamento (Electrónica)”, M.Sc. Thesis, Instituto Superior Técnico, Lisbon, Portugal, September 2008.

Abstract: This work has focused on the design, development and implementation of the electronic system which provides an aerial blimp robot with complete autonomy, following lines on the ground, or tracking a land robot – an iRobot ATRV Junior - in a real environment situation. For this purpose, a realistic simulator was

developed that allows the testing of all the algorithms installed in the blimp, so they can be visualized and their behaviour consequently calibrated to minimize adjustments between the laboratory experiments and the real environment. A DSP board was assembled to the existing blimp to receive images sent by an on board camera and to calculate all the control required to command the motors during the mission.

Keywords: digital signal processing, autonomy, aerial blimp robot, image processing

Members of the Thesis Committee:

Carlos Silvestre, Assistant Professor, IST, (P)

Francisco Alegria, Assistant Professor, supervisor, IST, (P)

José Santos-Victor, Associate Professor, IST (P)

Pedro Lima, Associate Professor, co-supervisor, IST (P)

Ricardo Alcácer, “Passarola: Dirigível Autónomo para Operações de Salvamento (Robótica)”, M.Sc. Thesis, Instituto Superior Técnico, Lisbon, Portugal, September 2008.

Abstract: In this thesis is presented the theoretical study of a blimp robot guidance and control system. The work shows the capability to build an operational guidance system for the aerial vehicle, fed by a non-pre-determined trajectory, resulting from tracking the motion of a ground vehicle or following lines painted on the ground. The mathematical model of the blimp dynamics is improved with respect to prior work, and the impulsive responses of the three aircraft subsystems are identified: translation in X, translation in Z, and rotation about Z. The study of the PD controller is done concerning the visual feedback control scheme proposed for the Passarola robot. The closed loop control error is defined for both cases (ground robot tracking and lines following) and determined by image processing techniques. The blimp controller was tested in two different types of simulators: theoretical simulation in Matlab and 3D realistic simulation in USARSim, with the use of the real control setup. The latter, adapted from the beginning of the project to the Passarola robot simulation, was carefully configured to represent Passarola attitude, turning it into a powerful investigation tool for this robot. The autonomous control system was then applied to the real robot, with very satisfactory results.

Keywords: Mobile robot navigation, image-based control, autonomous blimp, 3D dynamic simulation

Members of the Thesis Committee:

Carlos Silvestre, Assistant Professor, IST, (P)

Francisco Alegria, Assistant Professor, co-supervisor, IST, (P)

José Santos-Victor, Associate Professor, IST (P)

Pedro Lima, Associate Professor, supervisor, IST (P)

João Messias, “Task Specific Motion Control of Omnidirectional Robots”, M.Sc. Thesis, Instituto Superior Técnico, Lisbon, Portugal, September 2008.

Abstract: This thesis addresses the most common motion control (guidance) problems that a holonomic mobile robot has to face, with particular emphasis on the tasks that must be performed in a robotic soccer environment. The general situations where the robot must be driven to a reference posture (stabilization) or follow a reference trajectory (tracking) are considered. These problems are solved through feedback linearization, and the respective control laws are analyzed both in continuous-time and in discrete-time.

More specific tasks may require the interaction between the mobile robot and a moveable object in its environment: in a robotic soccer setting, two such tasks are those of intercepting a freely rolling ball and transporting the soccer ball. Solutions are presented to each of these problems, which explicitly take advantage of the omnidirectional capabilities of these robots. Ball interception is achieved through a solution that combines the concepts of trajectory-tracking and proportional navigation. Moving the ball is accomplished through a control scheme that determines at each instant the necessary force that must be applied to the ball, and then uses it as a reference for a hybrid force/position control law that drives the robot. In each of these problems, the limitations of the robot's actuators are considered.

In order for the proposed control solutions to be useful in cluttered environments, the problem of obstacle avoidance is considered. The proposed solution consists in determining the locally optimal direction for movement in a reactive manner, and specifically addresses environments that are sparsely populated with fast-moving objects

Keywords: Mobile robot motion control; Moving object interception; Nonlinear control; Object manipulation; Obstacle avoidance; Robotic soccer

Members of the Thesis Committee:

Carlos Silvestre, Assistant Professor, IST, (P)

João Sequeira, Assistant Professor, IST, (P)

Pedro Lima, Associate Professor, supervisor, (P)

<p>Francisco Mendonça, "Smooth Priorities", M.Sc. Thesis, Instituto Superior Técnico, Lisbon, Portugal, October 2008.</p>

Abstract: In multi-product, limited capacity production systems with uncertain demands a decision on the amount to produce for each product is needed when what would ideally be produced exceeds the capacity. One uses a production policy to provide that decision. In this thesis a new production policy called smooth priorities and that is intended as a fairer alternative to strict priorities is studied. A general model for production systems with various products that can describe both series and re-entrant systems is devised. IPA equations for the model with a smooth priorities policy are presented. Theoretical comparisons are made to the common policies of strict priorities and linear scaling. Software that implements the model, a general simulator and a general optimizer are devised allowing the study of any system that fits the model. Optimization based on IPA simulation is used to practically compare smooth and strict priorities with the conclusion that in general smooth priorities present better result for the studied cases. Function plots obtained from simulation are used to study the structure of the cost function of smooth priorities resulting in the knowledge that in general the function can exhibit local minima.

Keywords: Periodic Review Inventory Control, Multiple products and machines, Capacitated Systems, Base-stock Echelon Policies, Infinitesimal Perturbation Analysis

Members of the Thesis Committee:

Carlos Silvestre, Assistant Professor, IST, (P)

Susana Relvas, Assistant Professor, IST, (P)

Carlos Bispo, Assistant Professor, supervisor, IST (P)

Pedro Afonso, "Railway Traffic Management", M.Sc. Thesis, Instituto Superior Técnico, Lisbon, Portugal, October 2008.

Abstract: With the growing interest in the railway sector, mainly because of energetic reasons, there is also a need to increase the efficiency of the railway lines. One way to optimize this sector is to improve quality in the train control process itself. Nowadays, train dispatching is still mostly done by human operators that use elementary tools and thereby solving conflicts sub-optimally.

Motivated by these factors, this report presents a model capable of detecting and solving conflicts, for single track railways. More specifically, this model proposes two resolution methods: a heuristic resolution and a search for the optimal solution. To evaluate the quality of the developed model, several tests were made, obtaining encouraging results. These results showed that it is possible to solve conflicts optimally or near optimally, in a feasible amount of time.

This program comes with a graphic interface so that the interaction with the dispatcher can be more user friendly. The major novelties of this work regard the improvement on the conflict detection process, the introduction of capacity conflicts, and the creation of several parameters to adjust the search for the optimal solution.

Keywords: Re-scheduling, Single Track, Railway, Meet and Pass, Train, Conflict, Decision Support System

Members of the Thesis Committee:

Carlos Silvestre, Assistant Professor, IST, (P)

Paulo Teixeira, Assistant Professor, IST, (P)

Matthijs Span, PhD, ISR/IST (P)

Carlos Bispo, Assistant Professor, supervisor, IST (P)

Artur Prego, "Desenvolvimento e Análise de Comportamentos Relacionais em Robots Futebolistas", M.Sc. Thesis, Instituto Superior Técnico, Lisbon, Portugal, October 2008.

Abstract: The goal of this thesis was, supported by previous works in the area, to create, develop and test cooperative behaviors between soccer robots within the SocRob project. The modelling of the behaviors was based on Petri Nets and a new model of Petri Nets was introduced, based on previous works, in order to ease the creation of new cooperative behaviors. Dynamic passes between robots were introduced for the first time in the project.

Two kinds of dynamic passes were developed, short pass and long pass, and the individual behavior of the supporting robot was improved, in order to take more advantage of the two passes. These behaviors were tested in a simulator, and demonstrated using real robots.

A qualitative analysis of the developed Petri Net models was made, checking deadlocks and other logical properties, as well as a quantitative analysis of the results obtained using the simulator, based on equivalent Markov Chain models.

Keywords: Robotic Soccer, Petri Nets, Relational Behaviors, Qualitative Analysis, Quantitative Analysis

Members of the Thesis Committee:

Carlos Silvestre, Assistant Professor, IST, (P)

Rodrigo Ventura, Assistant Professor, IST, (P)

Pedro Lima, Associate Professor, supervisor, IST (P)

Fausto Ferreira, "RAPOSA: Robot Autónomo Para Operações de Salvamento", M.Sc. Thesis, Instituto Superior Técnico, Lisbon, Portugal, October 2008.

Abstract: Search and Rescue (SAR) Robotics has been gaining an increasing interest in recent years. In spite of that, there is still a considerable amount of work to be developed in terms of autonomy and usability. RAPOSA is a tele-operated robot for SAR operations that has a low level of autonomy. The only tasks that were performed automatically are the inversion of the image and of the commands for the wheels when the robot "flips" upside down. The main goal of this thesis is to endow RAPOSA with a higher autonomy level namely by providing a hole detection mechanism and an autonomous docking to the power and communications cable.

In this thesis, the hole detection is performed recurring to the infrared sensors. The autonomous docking is mainly based on vision using also odometry that was developed under this work as well. Side effects of this thesis are shown such as a new communications protocol.

The two points cited before were implemented and tested under various circumstances including outdoor environments. The new communications protocol, highly efficient (in terms of packet rate), is used nowadays, having solved some problems of the original one.

Keywords: Search and Rescue Robotics, Visual Servoing, Autonomous Docking

Members of the Thesis Committee:

Isabel Ribeiro, Full Professor, IST (P)

Pedro Lima, Associate Professor, IST (P)

Rodrigo Ventura, Assistant Professor, IST (P)

Carlos Silvestre, Assistant Professor, IST (P)

Dario Bacellar, "From Pixels to Objects - Enabling a spatial model for humanoid social robots", MSc. Thesis, Instituto Superior Técnico, Lisbon, Portugal, October 2008.

Abstract: This work adds the concept of object to an existent low-level attention system of the humanoid robot iCub. The objects are defined as clusters of SIFT visual features. When the robot first encounters an unknown object, found to be within a certain (small) distance from its eyes, it stores a cluster of the features present within an interval about that distance, using depth perception. Whenever a previously stored object crosses the robot's field of view again, it is recognized and mapped into an egocentric frame of reference. This mapping is persistent, in the sense that its positions are kept even when the objects are not in the robot's field of view. Features are stored and recognized in a bottom-up fashion. This work creates the foundation for a way of linking the bottom-up attention system with top-down, object-oriented information provided by humans.

Keywords: Object Recognition, Depth Perception; Stereo Computer Vision; Saliency Map

Members of the Thesis Committee:

Alexandre Bernardino, Assistant Professor, IST (P)

Manuel Lopes, PhD, IST (P)

Rodrigo Ventura, Assistant Professor, IST (P)

Carlos Silvestre, Assistant Professor, IST (P)

Cristina Aleixo, “A receptionist robot: navigation and image processing”, MSc. Thesis, Instituto Superior Técnico, Lisbon, Portugal, October 2008.

Abstract: The present thesis discusses part of a project consisting in the design, development, and implementation of a receptionist robot for the Institute for Systems and Robotics (ISR), located at Instituto Superior Técnico, in Lisbon. The robot is stationed at ISR’s 6th floor, at the elevator hall, where it is able to assist ISR’s visitors. It detects and approaches people passing by its surrounding area, offering its services. Human-robot communication can be established orally or by means of a tactile interface. If necessary, the robot is capable of guiding visitors anywhere on the floor.

In order to be able to perform all the required tasks, the robot counts with a number of different technologies, such as indoor navigation and localization, speech recognition and synthesis, face detection, and people detection. Whenever possible, these are implemented with off-the-shelf state-of-the-art open source software packages – the integration of existing software packages is one of the project’s assumptions.

The receptionist robot project is composed of two separate theses. Apart from the receptionist’s conception and system design, which is common to both, the present thesis focuses on the robot’s navigation and localization module, as well as on all the modules that employ image processing, which are the face detection, and the people detection modules.

Experimental results concerning these modules are also presented in this thesis.

Keywords: Receptionist Robot, Navigation, Localization, Image Processing, Face Detection, People Detection.

Members of the Thesis Committee:

José Alberto Santos-Victor, Associate Professor, IST (P)

Pedro Lima, Associate Professor, IST (P)

Rodrigo Ventura, Assistant Professor, IST (P)

Carlos Silvestre, Assistant Professor, IST (P)

Manuel Malhado, “A receptionist robot: interface and coordination”, M.Sc. Thesis, Instituto Superior Técnico, Lisbon, Portugal, October 2008.

Abstract: This thesis presents a project that consists on the development of a receptionist robot for the Institute for Systems and Robotics (ISR), Lisbon. This robot is stationed at ISR’s 6th floor elevator lobby where it waits for nearby visitors. At this point it attempts to interact with them in order to find out whether they wish to be lead to a specific room on this floor.

The followed development methodology focuses on the integration of several modules, featuring navigation and localization capabilities, a graphical interface, speech recognition and synthesis, people detection, face detection, and behavior control, in order to achieve an autonomous system. In order to save time and effort, as well as obtaining a robust solution, “off-the-shelf ” software packages are used whenever possible.

This project is covered by two Master theses. The present one focuses, apart from the conception of the robot’s hardware and software architecture design, on its human-robot interaction capabilities, as well as on the integration and coordination among all modules.

Experimental results obtained in order to evaluate the employed speech recognition engine robustness in the present application and the integrated system overall performance, are also presented in this thesis.

Keywords: Receptionist robot, human-robot interaction, graphical interface, speech recognition, behavior control.

Members of the Thesis Committee:

José Alberto Santos-Victor, Associate Professor, IST (P)

Pedro Lima, Associate Professor, IST (P)

Rodrigo Ventura, Assistant Professor, IST (P)

Carlos Silvestre, Assistant Professor, IST (P)

Samuel António Tojal Ferreira, “Predtrack - Predição de Alvos Móveis: Aplicação ao Controlo de uma Cabeça Robótica,” M.Sc. Thesis, Instituto Superior Técnico, Lisbon, Portugal, November 2008.

Abstract: This thesis presents an oculomotor control system for humanoid robots. We combine three important aspects of head-eye coordination found in humans. Smooth-pursuit motions are driven by target velocity stimulus and include a predictive scheme to allow small tracking errors. Saccades are driven by large errors in target position and controlled by visual inverse kinematics both for changing interest point and reduce accumulated tracking errors. The redundant degrees of freedom in the eye-head system are exploited to define expressive postures in the robot head, as well as considering other criteria such as energy minimization and comfort. The performance of the proposed system is illustrated both with a simulator and with the real system. Results show the suitability of the proposed human-inspired techniques for tracking objects with reduced lags and generation of expressive postures. The current model assumes low inertia joints which is not a good approximation to the real robot and limits the effectiveness of motion prediction. Future work will address a better dynamical modelling of the system in order to further improve the tracking performance.

Keywords: Binocular Heads, 3D Reconstruction, Redundant Inverse Kinematic, Saccades, Kalman Filter

Members of Thesis Committee:

Carlos Jorge Ferreira Silvestre, IST (P)

Alexandre José Malheiro Bernardino, IST (P) (supervisor)

Rodrigo Martins de Matos Ventura, IST (P)

Daniela Filipa Gonçalves Pamplona, “Gaussian Foveation,” M.Sc. Thesis, Instituto Superior Técnico, November 2008.

Abstract: Foveal images are space-variant representations of the visual field, usually providing a higher acuity in the image center, to emulate certain aspects of the human retina. In this paper we propose a framework for the synthesis, analysis and processing of foveal images based on Gaussian shaped receptive fields. We formulate the forward and inverse transformations between uniform and non-uniform image spaces, in order to perform image processing operations in the transform domain we use basic Operator Theory. We present experiments illustrating the performance of the proposed approach in a motion-estimation and tracking problem, and compare it with classical approaches to space-variant image processing.

Members of the Thesis Committee

Prof. Ana Bela Cruzeiro

Prof. Alexandre José Malheiro Bernardino (Orientador), IST (P)

Prof. Carlos José Santos Alves (co-Orientador)

Prof. Ana Leonor Silvestre

Nuno Filipe Maia Lucas, “Ekit - Kit de Apoio à Aprendizagem de Sinais, Circuitos e Sistemas Electrónicos,” M.Sc. Thesis, Instituto Superior Técnico, November 2008.

Abstract: The increase of student mobility in Europe and in other countries, and the recent attempt to harmonize European curricula at the graduation and post-graduation levels lead towards an increasing co-operation among universities to develop educational modules with a common background . With Bolonha coming into effect in most universities the self-learning processes lead to the abolition of many experimental classes in the electronic graduations courses. This thesis describes a project which aims to provide the students an independent learning tool. The Ekit seeks to acquire practical knowledge through experience, which provides a complete supplement to the knowledge offered only in theory, in particular, signals, circuits and electronic systems. Using only one equipment simple to handle and easy to acquire, it is possible to carry out experiments on measuring resistors, capacitors, DC motor parameters and frequency responses of dynamic systems.

Members of the thesis committee:

José Antonio da Cruz Pinto Gaspar, (supervisor), IST (P)

João Fernando Cardoso Silva Sequeira, IST (P)

Carlos Jorge Ferreira Silvestre, IST (P)

João Miguel Raposo Sanches, IST (P)

Bruno Filipe Simão Dias, “Automatic Transcription of Musical Whistling,” M.Sc. Thesis, Instituto Superior Técnico, November 2008.

Abstract: In the first part of this dissertation we describe an automatic system for transforming (transcribing) man-made melodic whistles into MIDI-like symbolic representations. Given the monophonic nature of whistling, our system is mainly based in pitch detection and tracking methodologies. In particular, we compare four pitch detection techniques: Temporal Autocorrelation Function (tACF), Average Magnitude Difference Function (AMDF), Spectral Autocorrelation Function (fACF), and the Harmonic Product Spectrum (HPS). An onset detection function (High Frequency Content), and a set of non-linear filtering, used to convert durations, onsets and pitches into a musical notation, were also implemented. Results for both synthetic and real (man-made) whistling signals are presented in this report, showing that the system can effectively do the transcription work. A comparative evaluation of the four pitch detection algorithms is also performed. In the second part of the dissertation we present an application of the transcription system to the retrieval of musical themes. Users whistle a segment of a song as input, and as output they receive a list of music candidates, ranked by their relevance. In order to build an efficient and error tolerant retrieval system, the central component of the system, melody matching, is implemented based on dynamic programming. Three matching distances are presented to rank the retrieval results. Performance measure metrics show promising results in the retrieval system.

Members of the Thesis Committee:

Rodrigo Martins de Matos Ventura (co-supervisor), IST (P)

Jose Antonio da Cruz Pinto Gaspar (co-supervisor), IST (P)

Carlos Jorge Ferreira Silvestre, IST (P)

Joao Miguel Raposo Sanches, IST (P)

Giovanni Saponaro, “Object Manipulation from Simplified Visual Cues”, M.Sc. Thesis, Università di Roma La Sapienza, 2008

Abstract: Humanoid robotics in general, and human robot interaction in particular, is gaining new, extensive fields of application, as it gradually becomes pervasive in our daily life. One of the actions that humanoid robots must perform is the manipulation of things (reaching their arms for objects, grasping and moving them). However, in order to do this, a robot must first have acquired some knowledge about the target object and its position in space. This can be accomplished with a perceptual approach.

The developed system described in this thesis is based on the CAMSHIFT visual tracker and on a 3D reconstruction technique, providing information about position and orientation of a generic, model-free object that moves in the field of view of a humanoid robot platform. An object is perceived in a simplified way, by approximating it with its best-fit enclosing ellipse.

After having computed where an object is currently placed in front of it, the robotic platform can perform reaching tasks. Experiments obtained with the robot arm of the adopted platform are discussed.

Members of the Thesis Committee:

Prof. Daniele Nardi (supervisor)

Prof. Alexandre Bernardino (co-supervisor)

João Santos, “Multi-Robot Cooperative Object Localization: Decentralized Bayesian Approach”, M.Sc. Thesis, Instituto Superior Técnico, Lisbon, Portugal, December 2008.

Abstract: When operating in a complex unstructured environment, a team of cooperative robots becomes a team of sensors, each making observations to build a perception of reality that can be improved by others. A sensor model describes the uncertainty associated with each observation allowing to extract relevant information, rather than simple raw data from a physical device.

The sensor models are often nonlinear resulting in non-Gaussian posterior distributions. However, a parametric (e.g. Gaussian) approximation of sensors information is usually a better choice given the low computational power and low communications bandwidth it requires when sharing information. This is achieved at the cost of a limited representation of the sensors belief. Non parametric discrete approximations, such as Particle Filters, are able to capture arbitrarily complex uncertainty, but are intractable when it comes to communicating the state distribution due to the necessity of transmitting a large sample-based representation.

We aim at developing a cooperative sensor fusion model for mobile robots acting in dynamic environments. Our case study is the RoboCup MSL, where we implemented a shape-based 3D tracker for the target at hand: the ball. Furthermore, we aim at conceiving a more accurate probabilistic representation of the information shared between sensors, that copes with nonlinear sensor models. We took particle filters, Gaussian Mixture Model and a decentralized Bayesian approach to propose a cooperative sensor model that improves ball tracking and self-localization.

Keywords: Decentralized Sensor Fusion, Distributed Particle Filter, Gaussian Mixture Models, 3D Tracking, RoboCup

Members of the Thesis Committee:

Carlos Silvestre, Assistant Professor, IST (P)

Alexandre Bernardino, Assistant Professor, IST (P)

Pedro Lima, Associate Professor, supervisor, IST (P)

João Mota, “Distributed Algorithms for Sparse Reconstruction”, M.Sc. Thesis, Instituto Superior Técnico, Lisbon, Portugal, 2008.

Abstract: Many applications require the knowledge of a sparse linear combination of elementary signals that can explain a given signal. This problem is known as “sparse approximation problem” and arises in many fields of electrical engineering and applied mathematics. The great difficulty when dealing with sparse approximation problems is the lack of convexity or the non-differentiability inherent to the sparsity measures. This paper proposes and analyzes some distributed algorithms that solve a sparse convex approximation problem known as the “basis pursuit” problem. The interest in solving this problem distributedly concerns applications such as communications, computing and sensor networks. All the proposed algorithms assume that the matrix which contains the description of elementary signals is partitioned either horizontally or vertically among the several processors available. Nevertheless, each algorithm is based on a particular architecture for the links between the processors. We also state results of convergence for all the proposed algorithms. This requires extending the well-known results of convergence of the Diagonal Quadratic Approximation and the Nonlinear Gauss-Seidel methods to cover a new class of non-differentiable functions, which we call “rigid functions”.

Keywords: Basis Pursuit, Distributed Algorithms, Nonlinear Gauss–Seidel, Diagonal Quadratic Approximation, Subgradient Method, Rigid Functions.

Members of the Thesis Committee:

Prof. Carlos J. Silvestre, IST (P)

Prof. Mário A. T. Figueiredo, IST (P)

Prof. Pedro M. Q. Aguiar, IST (P)

Prof. João M. F. Xavier, IST (P)

Augusto Santos, “Subspace Segmentation”, M.Sc. Thesis, Instituto Superior Técnico, Lisbon, Portugal, 2008.

Abstract: Segmenting a mixture of linear subspaces is a crucial tool and either a theoretical challenge for computer vision regarding motion and image segmentation, structure-from-motion or object recognition. We present two mathematical formulations and a couple of algorithms to tackle the subspace segmentation problem. We also present a special case in which this problem, which is NP-Hard, can be partially characterized through a linear program. Firstly, we formulate the problem as an optimization program; maximization of a convex function restricted to a compact convex set. As the problem is NP-Hard, global optimality depends on initialization but once the maximum consensus subspace (MSC) is found our technique inherently guarantees the robustness to outliers. We present a robust segmentation algorithm by incorporating the Minorization-Maximization technique (MM) to achieve local maximizers in our model and a escaping heuristic aiming the global one. One drawback is that this method needs prior knowledge concerning the number and respective dimensions of the subspaces. Through numerical simulations in both synthetic and real data, we could see that our algorithm have never classied an outlier as inlier. Moreover it segments the articulated case as well as the independent case. In our second approach, we segment subspaces searching for the orthogonal complement. Our model consists in the minimization of a convex function that works as an heuristic for the l_0 -norm. The method incorporates an algorithm that switches from the steepest descent direction and the newton's method which is superlinear with a properly initialization. It does not require prior knowledge of the number or dimensions of the subspaces. The purposed algorithms do not rely on rank detection as most of current works.

Keywords: subspace segmentation, convex analysis, subdierential.

Members of the Thesis Committee:

Prof. Carlos J. Silvestre, IST (P)

Dr. Alessio Del Bue, IST (P)

Prof. João M. F. Xavier, IST (P)

Pedro Guerreiro, “Linear Discriminant Analysis Algorithms”, M.Sc. Thesis, Instituto Superior Técnico, Lisbon, Portugal, 2008.

Abstract: We propose new algorithms for computing linear discriminants to perform data dimensionality reduction from R^n to R^p , with $p < n$. We propose alternatives to the classical Fisher’s Distance criterion, namely, we investigate new criteria based on the: Chernoff-Distance, J-Divergence and Kullback-Leibler Divergence. The optimization problems that emerge of using these alternative criteria are non-convex and thus hard to solve. However, despite the non-convexity our algorithms guarantee global optimality for the linear discriminant when $p = 1$. This is possible due to problem reformulations and recent developments in optimization theory [8],[9]. A greedy suboptimal approach is developed for $1 < p < n$.

Keywords: Linear Discriminants, Data Dimensionality Reduction, Fisher’s Distance, Chernoff-Distance, Nonconvex strong duality results, Kullback-Leibler Divergence.

Members of the Thesis Committee:

Prof. Carlos J. Silvestre, IST (P)

Prof. José Bioucas Dias, IST (P)

Prof. Pedro M. Q. Aguiar, IST (P)

Prof. João M. F. Xavier, IST.(P)

Miguel dos Santos Venâncio, “2D and 3D medical imaging registration”, M.Sc. Thesis, Instituto Superior Técnico, Lisbon, Portugal, 2008.

Abstract: Image registration is about finding corresponding points in different images. In medical imaging applications, registration allows the comparison between images of the same modality for different subjects, for instance to compare images of healthy subjects with those of subjects with a certain disease. It also allows the comparison of images from the same subject, for instance to evaluate the progression of a disease, or the comparison of different modalities of images from the same subject, thus increasing the available information to help in the diagnosis. There are two types of image processing techniques that are usually used to perform the registration: the feature based techniques and the intensity based techniques. The first type of techniques relies on a prior step to detect salient points which normally requires human interaction. The second type of techniques is based on the minimization of a cost function which is usually based on the assumption that the image intensity is the same in both images. However, this is not true for some medical image modalities. This work addresses registration of 2D and 3D medical images without feature correspondence which can be used in images with different intensities.

Keywords: Image registration, iterative closest point, intensity normalization, medical imaging

Members of the Thesis Committee:

Prof. Carlos J. Silvestre, IST (P)

Prof. Margarida Silveira, IST (P)

Prof. Pedro M. Q. Aguiar, IST (P)

Prof. Jorge Salvador Marques, IST (P)

Pedro Gomes, "Coastline-following Preview Controller for the Delfimx Vehicle", M.Sc. Thesis, Instituto Superior Técnico, Lisbon, Portugal, 2008.

Sérgio Brás, "Pose Observers for Unmanned Air Vehicles", M.Sc. Thesis, Instituto Superior Técnico, Lisbon, Portugal, 2008.

Miguel Leitão, "Nonlinear Flight Control: Dynamic Inversion Based Control of Aircraft Pitch", M.Sc. Thesis, Instituto Superior Técnico, Lisbon, Portugal, 2008.

Joana Gomes, "Multiple model underwater tracking systems", M.Sc. Thesis, Instituto Superior Técnico, Lisbon, Portugal, 2008.

Emílio Pereira, "Robust Nonlinear Motion Control for Multiple Autonomous Robotic Vehicles", M.Sc. Thesis, Instituto Superior Técnico, Lisbon, Portugal, 2008.

Tiago Gaspar, "Indoor Target Tracking Vision Systems", M.Sc. Thesis, Instituto Superior Técnico, Lisbon, Portugal, 2008.

Renato Sousa, "Advanced Marine Vehicles Target Trackers", M.Sc. Thesis, Instituto Superior Técnico, Lisbon, Portugal, 2008.

Luis Gomes, "Advanced Signal Processing Techniques for Integrated Navigation", M.Sc. Thesis, Instituto Superior Técnico, Lisbon, Portugal, 2008.

CHAN Chun-Ning, "Advanced NAVSTAR-GPS Positioning Techniques for", M.Sc. Thesis, Instituto Superior Técnico, Lisbon, Portugal, 2008.

2.3.2 Theses in Progress during 2008

In this subsection the Doctoral and Master theses in progress during 2008, at ISR/IST (ECE) and ISR/Algarve (ECE), are identified and ordered by the scientific research area:

DOCTORAL THESES (56)

Research Area: Decentralized State Estimation for Satellite Formations

Title: Decentralized Low Communication 6DoF Full State Formation Navigation

Doctoral Student: Sónia Marques

Advisor: Pedro Lima

Initiated: September 2001

Expected conclusion: 2009

Current Status: Delivered thesis to committee

Research Area: Preference elicitation, expected utility theory

Title: Extração de Preferências por Meio de Avaliação de Comportamentos Observados

Doctoral Student: Valdinei Silva

Advisor: Pedro Lima (IST), Anna R. Costa (U. São Paulo, Brasil) – double degree

Initiated: February 2003

Expected conclusion: April 2009

Current Status: Delivered thesis to committee

Grant: GRICES/CAPES

Research Area: Petri Net Based Modelling and Coordinated Execution of Robotic Tasks

Doctoral Student: Hugo Costelha

Advisor: Pedro Lima

Initiated: October 2003

Expected conclusion: 2009

Current Status: On-going, finished PhD coursework, candidacy exam passed

Grant: FCT (now finished)

Research Area: Multi-Agent Reinforcement Learning for Stochastic Games

Doctoral Student: Gonçalo Neto

Advisor: Pedro Lima

Initiated: October 2003

Expected conclusion: 2009

Current Status: On-going, finished PhD coursework, candidacy exam passed

Grant: FCT (now finished)

Research Area: Cooperative Perception

Doctoral Student: Abdolkarim Pahlani

Advisor: Pedro Lima

Initiated: February 2005

Expected conclusion: 2010

Current Status: On-going, finished PhD coursework

Grant: FCT

Research Area: Robotic tasks modelling and supervision using DES theory

Doctoral Student: Bruno Lacerda

Advisor: Pedro Lima

Initiated: September 2008

Expected conclusion: 2012

Current Status: On-going, starting PhD coursework

Grant: FCT

Research Area: Planning under uncertainty for multi-robot systems

Doctoral Student: João Messias

Advisor: Pedro Lima, Matthijs Spaan

Initiated: September 2008

Expected conclusion: 2012

Current Status: On-going, starting PhD coursework

Grant: FCT

Research Area: Institutional robotics, swarm robotics

Doctoral Student: José Nuno Pereira

Advisor: Pedro Lima, Porfirio Silva, Alcherio Martinoli (EPFL)

Initiated: September 2008

Expected conclusion: 2012

Current Status: On-going, starting PhD coursework

Grant: FCT (IST/EPFL dual degree PhD program)

Research Area: Vision-based implicit communication for cooperative behaviours

Doctoral Student: Aamir Ahmad

Advisor: Pedro Lima

Initiated: September 2008

Expected conclusion: 2012

Current Status: On-going

Grant: URUS project

Research Area: Computer Vision

Title: Recognition of Human Activities from video

Doctoral Student: Pedro Canotilho Ribeiro

Advisor: José Santos-Victor

Initiated: 2003

Expected conclusion: 2009

Current Status: On hold

Grant: FCT

Research Area: Computer Vision

Title: Image matching

Doctoral Student: Ricardo Ferreira

Advisor: João Paulo Costeira
Initiated: 2005
Expected conclusion: 2008
Current Status: On-going
Grant: FCT

Research Area: Computer Vision
Title: Biological inspired audio-visual learning.
Doctoral Student: Karl Jonas Hornstein
Advisor: José Santos-Victor
Initiated: 2005
Expected conclusion: 2009
Current Status: On-going
Grant: FCT

Research Area: Computer Vision
Title: Learning in computer Vision
Doctoral Student: Bruno Damas
Advisor: José Santos-Victor
Initiated: 2007
Expected conclusion: 2010
Current Status: On-going
Grant: FCT

Research Area: Computer Vision
Title: Visual servoing.
Doctoral Student: Matteo Tajana
Advisor: Alexandre Bernardino
Initiated: 2008
Expected conclusion: 2011
Current Status: On-going
Grant: FCT

Research Area: Computer Vision
Title: Visual Reconstruction of deformable surfaces.
Doctoral Student: Ricardo Ferreira
Advisor: Joao Paulo Costeira
Initiated: 2006
Expected conclusion: 2010
Current Status: On-going
Grant: FCT

Research Area: Computer Vision
Title: Subspace Matching and Recognition.

Doctoral Student: Manuel Ricardo Marques
Advisor: Joao Costeira
Initiated: 2007
Expected conclusion: 2011
Current Status: On-going
Grant: FCT

Research Area: Computer Vision
Title: Visual Attention and space variant vision
Doctoral Student: Jonas Ruesch
Advisor: Alexandre Bernardino
Initiated: 2008
Expected conclusion: 2011
Current Status: On-going
Grant: FCT

Research Area: Micro-robotics
Title: Micro robots for surgical intervention.
Doctoral Student: Ricardo Beira
Advisor: José Santos-Victor (IST), Hannes Bleuler (EPFL)
Initiated: 2005
Expected conclusion: 2010
Current Status: On-going
Grant: FCT

Research Area: Navigation and Control
Title: Navigation and Control of Marine Vehicles
Doctoral Student: Pramod Maurya
Advisor: António Pascoal
Expected conclusion: 2011
Current Status: On-going
Grant: ISR and FCT

Research Area: Control Theory
Title: Multiple Model Adaptive Estimation and Control
Doctoral Student: Vahid Hassani
Advisor: António Pascoal and Michael Athans
Expected conclusion: 2011
Current Status: On-going
Grant: ISR and FCT

Research Area: Multiple Vehicle Cooperative Motion Planning
Title: Multiple Vehicle Cooperative Path Following
Doctoral Student: Andreas Hausler

Advisor: António Pascoal and António Aguiar

Expected conclusion: 2011

Current Status: On-going

Grant: FREESUBNetwork

Research Area: Dynamical Systems and Control

Title: Cooperative Control of Autonomous Vehicles in Formation

Doctoral Student: João Almeida

Advisor: Carlos Silvestre and António Pascoal

Expected conclusion: 2011

Current Status: On-going

Grant: FCT

Research Area: Underwater Positioning and Inertial Navigation Systems; Sensor fusion; Nonlinear estimation

Title: Inertial Navigation and Positioning Systems for Autonomous Marine Robots

Doctoral Student: Marco Morgado

Advisor: Paulo Oliveira and Carlos Silvestre

Expected conclusion: 2011

Current Status: On-going

Grant: FCT

Research Area: Estimation, Sensor Fusion and Decision Systems

Title: Nonlinear Systems for Target Tracking and Navigation Aiding in Autonomous Robotics.

Doctoral Student: Tiago Gaspar

Advisor: Paulo Oliveira

Expected conclusion: 2013

Current Status: On-going

Grant: FCT

Research Area: Robust Adaptive Control

Title: Contributions to Robust Adaptive Control

Doctoral Student: Paulo Rosa

Advisor: Carlos Silvestre and Michael Athans

Expected conclusion: 2011

Current Status: On-going

Grant: FCT

Research Area: Control of autonomous vehicles

Title: Nonlinear model predictive control of autonomous vehicles in the presence of obstacles

Doctoral Student: Bruno Guerreiro

Advisor: Carlos Silvestre

Expected conclusion: 2011

Current Status: On-going

Grant: FCT

Research Area: Nonlinear Observers

Title: Observers for Position and Autonomous Vehicle Position and Attitude Estimation

Doctoral Student: Sérgio Brás

Advisor: Carlos Silvestre and Paulo Oliveirda

Expected conclusion: 2010

Current Status: On-going

Grant: FCT

Research Area: Navigation and Positioning

Title: Navigation and Tracking Systems for Autonomous Vehicles

Doctoral Student: Mohammadreza Bayat

Advisor: António Aguiar

Expected conclusion: 2012

Current Status: On-going

Grant: FCT

Research Area: Navigation and Control Systems

Title: Sensor Based Navigation and Control of Autonomous Vehicles

Doctoral Student: Pedro Batista

Advisor: Carlos Silvestre and Paulo Oliveira

Expected conclusion: 2012

Current Status: On-going

Grant: FCT

Research Area: Dynamical Systems and Control

Title: Sensor Based Control of Multi-Rotor Aerial Vehicles

Doctoral Student: Pedro Serra

Advisor: Carlos Silvestre and Rita Cunha

Expected conclusion: 2012

Current Status: On-going

Grant: FCT

Research Area: Dynamical Systems and Control

Title: Motion Control of Autonomous Aerial Vehicles

Doctoral Student: David Cabeçinhas

Advisor: Carlos Silvestre

Expected conclusion: 2011

Current Status: On-going

Grant: FCT

Research Area: Underwater Acoustics
Title: Environmental based underwater communications
Doctoral Student: António João Silva
Advisor: Prof. Sérgio Jesus (UAIG/ISR)
Co-advisor: Prof. João Pedro Gomes (IST/ISR)
Initiated: 2007
Expected conclusion: 2009
Current Status: On-going
Grant: N/A

Research Area: Underwater Acoustics
Title: N/A
Doctoral Student: Paulo Santos
Advisor: Prof. Paulo Felisberto (UAIG/ISR)
Initiated: 2007
Expected conclusion: 2009
Current Status: On-going
Grant: FCT

Research Area: Underwater Acoustics
Title: N/A
Doctoral Student: Nelson Martins
Advisor: Prof. Sérgio Jesus (UAIG/ISR)
Initiated: 2007
Expected conclusion: 2009
Current Status: On-going
Grant: FCT

Research Area: computer graphics
Title: Categorisation and recognition of 3D triangulated objects
Doctoral Student: Roberto Lam
Advisor: Prof. Hans du Buf (UAIG/ISR)
Initiated: 2007
Expected conclusion: 2011
Current Status: On-going
Grant: N/A

Research Area: human vision, neurocomputing
Title: Face and object recognition by 3D cortical representations
Doctoral Student: Jaime A. Martins
Advisor: Prof. Hans du Buf (UAIG/ISR)
Initiated: 2007
Expected conclusion: 2011
Current Status: On-going
Grant: FCT

Research Area: Biomedical Engineering

Title: Characterization the Carotid Arteries and Atherosclerotic Disease with 3D Ultrasound.

Doctoral Student: José Seabra

Advisor: João Sanches

Initiated: 2007

Expected conclusion: 2010

Current Status: On-going

Grant: FCT

Research Area: Confocal Microscopy

Title: Cell nucleus Reconstruction from fluorescence confocal microscopy images.

Doctoral Student: Isabel Rodrigues

Advisor: João Sanches

Initiated: 2007

Expected conclusion: 2010

Current Status: On-going

Grant:

Research Area: Biomedical Engineering

Title: Diagnosis and Characterization of the Liver Steatosis from Ultrasound images

Doctoral Student: Ricardo Ribeiro

Advisor: João Sanches

Initiated: 2008

Expected conclusion: 2011

Current Status: On-going

Grant:

Research Area: Biomedical Engineering

Title: Hepatocarcinoma detection from Dynamic Contrast Enhanced MRI (DCE-MRI)

Doctoral Student: João Casteleiro

Advisor: João Sanches

Initiated: 2008

Expected conclusion: 2011

Current Status: On-going

Grant:

Research Area: Biomedical Engineering

Title: Diffuse Liver Disease diagnosis from multimodal images

Doctoral Student: Nuno Nobre

Advisor: João Sanches

Initiated: 2008

Expected conclusion: 2011

Current Status: On-going

Grant:

Research Area: Sensor Networks
Title: Joint Sensor Localization and Target Tracking using Range Measurements
Doctoral Student: Pinar Oguz Ekim
Advisor: João Pedro Gomes
Co-advisor: Paulo Oliveira
Initiated: 2008
Expected conclusion: 2013
Current Status: On-going
Grant: FCT

Research Area: Communications
Title: Frequency Domain Detection Techniques for DS-CDMA and MC-CDMA Signals
Doctoral Student: Paulo Silva
Advisor: Rui Dinis
Initiated:
Expected conclusion: 2009
Current Status: On-going
Grant:

Research Area: Communications
Title: Nonlinear Distortion Effects on Multicarrier Signals
Doctoral Student: Teresa Araújo
Advisor: Rui Dinis
Initiated:
Expected conclusion: 2010
Current Status: On-going
Grant:

Research Area: Sensor Networks
Title: Distributed algorithms for Sensor Networks
Doctoral Student: Dusan Djakovetic
Advisor: Prof. João Xavier (ISR/IST) and Prof. José Moura (CMU)
Initiated: 2008
Expected conclusion: 2011
Current Status: On-going
Grant: FCT

Research Area: Sensor Networks
Title: Sensor selection algorithms for detection hypothesis
Doctoral Student: Dragana BAJOVIC
Advisor: Prof. João Xavier (ISR/IST) and Prof. Bruno Sinopoli (CMU)
Initiated: 2008
Expected conclusion: 2011
Current Status: On-going
Grant: FCT

Research Area: Distributed and Parallel Algorithms
Title: Optimization algorithms for multi-core platforms
Doctoral Student: João Mota
Advisor: Prof. João Xavier (ISR/IST), Prof. Pedro Aguiar (ISR/IST) and Prof. Markus Pueschel (CMU)
Initiated: 2008
Expected conclusion: 2011
Current Status: On-going
Grant: FCT

Research Area: Computer vision
Title: Shape analysis
Doctoral Student: José Rodrigues
Advisor: Prof. Pedro Aguiar (ISR/IST), Prof. João Xavier (ISR/IST) and Prof. Takeo Kanade (CMU)
Initiated: 2008
Expected conclusion: 2011
Current Status: On-going
Grant: FCT

Research Area: Signal and Image Processing
Title: N/A
Doctoral Student: Augusto Santos
Advisor: Prof. João Xavier (ISR/IST) and Prof. José Moura (CMU)
Initiated: 2008
Expected conclusion: 2011
Current Status: On-going
Grant: FCT

Research Area: Computer vision
Title: N/A
Doctoral Student: Ricardo Ferreira
Advisor: Prof. João Costeira (ISR/IST) and Prof. João Xavier (ISR/IST)
Initiated: 2006
Expected conclusion: 2010
Current Status: On-going
Grant: FCT

Research Area: Evolutionary Algorithms
Title: Diversity-Enhanced Evolutionary Algorithms for Dynamic Optimization
Doctoral Student: Carlos Fernandes
Advisor: Agostinho Rosa
Initiated: December 2004
Expected Conclusion: 2009
Current Status: Delivered
Grant: FCT

Research Area: Biomedical Engineering

Title: Análise da Microestrutura do EEG do Sono por ondeletas e Sintonia do detector por Computação Evolutiva

Doctoral Student: Rogério Largo

Advisor: Agostinho Rosa

Initiated: 2005

Expected conclusion: 2009

Current Status: Writing

Grant: EST-IPS

Research Area: Artificial Life – Evolutionary Systems

Title: Metodologias Evolucionistas na protecção e gestão de colheitas

Doctoral Student: Gong Hongfei

Advisor: Agostinho Rosa

Initiated: December 2003

Expected Conclusion: 2009

Current Status: thesis writing and final results

Grant: FCT

Research Area: Biomedical Engineering

Title: Algoritmo para Evolução de Matrizes de pesos por Alinhamento Múltiplo Inverso de Sequências Proteicas

Doctoral Student: Nelson Pereira

Advisor: Agostinho Rosa

Initiated: 2005

Expected Conclusion: 2010

Current Status: on going

Grant: FCT

Research Area: Biomedical Engineering

Title: Processamento e Classificação de Eventos Fasicos no Sono

Doctoral Student: Daria Migotina

Advisor: Agostinho Rosa

Initiated: 2006

Expected Conclusion: 2010

Current Status: Just started

Grant: FCT

Research Area: Biomedical Engineering

Title: Simulator of Artificial Immune System

Doctoral Student: Nuno Fachada

Advisor: Agostinho Rosa

Initiated: 2008

Expected Conclusion: 2012

Current Status: started

Grant: FCT

MASTER THESES (5)

Research Area: Biomedical Engineering
Title: Adaptive paradigm design in functional MRI
Master Student: Indira Andrade
Advisor: João Sanches
Initiated: 2008
Expected conclusion: 2009
Current Status: On-going
Grant:

Research Area: Texture analysis for local and global gist vision
Title: N/A
Master Student: João José
Advisor: Prof. Hans du Buf (UAIG/ISR)
Initiated: 2007
Expected conclusion: 2010
Current Status: On-going
Grant: N/A

Research Area: Neural correlates of human facial expressions
Title: N/A
Master Student: Ricardo Sousa
Advisor: Prof. Hans du Buf (UAIG/ISR)
Initiated: 2007
Expected conclusion: 2010
Current Status: On-going
Grant: N/A

Research Area: Computer vision
Title: N/A
Master Student: Ricardo CABRAL
Advisor: Prof. Pedro Aguiar (ISR/IST) and Prof. João Xavier (ISR/IST)
Initiated: 2008
Expected conclusion: 2009
Current Status: On-going
Grant:

Research Area: Biomedical Engineering
Title: Recognition of Alzheimer Disease Patterns in PET Images
Master Student: Fábio Joel Vieira da Silva
Advisor: Margarida Silveira and Jorge Salvador Marques

Initiated: 2008

Expected conclusion: 2009

Current Status: On-going

Grant:

2.4 ADVANCED TRAINING

2.4.1 Courses

António Aguiar

- Nonlinear Systems

Carlos Silvestre

- Linear Systems
- Robust Multivariable Control

João Xavier

- “Nonlinear Optimization”, Ph.D. course, IST, Lisbon, Portugal.
- “Nonlinear Signal Processing”, Ph.D. course, IST, Lisbon, Portugal.

Jorge S. Marques

- “Image Motion Analysis”, Ph.D. Course, Universidade Autónoma de Barcelona, Spain.
- “Estimation and Classification”, Ph.D. Course, IST, Lisbon, Portugal.

Manuel Lopes, Luis Montesano, Matthijs Spaan, Giampiero Salvi, José Santos-Victor, Alexandre Bernardino

- “Learning Robots”, March 2008. One week course for international students of the ATHENS network.
- “Learning Robots”, November 2008. One week course for international students of the ATHENS network.

Paulo Oliveira

- Detection, Estimation, and Filtering.

Sérgio Jesus

- Signal and Systems module of 6 hours to circa 20 students from 10 countries at the Summer School in Underwater Acoustics, organized by FORTH (Greece) under EU project DAMOCLES in the period 26 - 28 June 2008;

2.4.2 Seminars

- **During 2008 the following Seminars were given outside ISR:**

Jorge S. Marques

- “Robust Shape Tracking”, Computer Vision Center, Universidade Autónoma de Barcelona, February, 2008.

José Santos-Victor

- “Research Projects @ VisLab”, invited talk, École Polytechnique Fédérale de Lausanne, Switzerland, December 2008.

Pedro Lima

- “Basics of Control Theory and Practice”, PhD Program on Computational Biology, Instituto Gulbenkian de Ciência, Oeiras, June 2008.
- 2SocRob: Science Beyond Soccer”, International Summer Science Camp 2008, Lisbon, August 2008;
- The Portuguese Robotics Open: Putting Robotics on the Map, invited talk within the framework of the Peer Learning Activity working group on the European Union Math, Science and Technology cluster (Directorate General for Education and Culture), Agência Nacional para a Cultura Científica – Ciência Viva and Direcção Geral de Inovação e Desenvolvimento Curricular, Centro Ciência Viva, Vila do Conde, October 2008.
- “Engineering or Emergence? Experiences with Robot Collectives”, 6º Forum Internacional dos Investigadores Portugueses (FIIP), Lisbon, December 2008;

• Monthly seminars with Mathematic Department

"A geometric view of hybrid systems"

Gabriel Pires (DM/IST)

April 2008

"ANSIG: An Analytic Signature for Permutation-Invariant Two-Dimensional Shape representation"

José Rodrigues (ISR/IST)

April 2008

"Reconstruction of a 2D Flat Manifold From Isometrically Embedded 3D Features"

Ricardo Ferreira (ISR/IST)

May 2008

"What is an algebraic surface?"

Margarida Mendes Lopes (CAMGSD/DM-IST)

May 2008

• ISR Regular seminars

In a regular basis, and organized by Paulo Oliveira, the following seminars were held:

"An Introduction to Multiple View Geometry"

Dr. Lourdes Agapito, Queen Mary Univ. of London

January 2008

"An adaptive sensori-motor representation of peripersonal space"

Micha Hersh, Learning Algorithms and Systems Laboratory, EPFL

January 2008

"Efficient MIMO soft demodulation: A semidefinite relaxation approach"

Prof. Tim Davidson, Dept. Electrical and Computer Engineering, McMaster University, Canada

February 2008

“Observer design for a class of kinematic systems”

Pedro Batista, ISR/IST PhD student

March 2008

“On the Design of Linear Parameter Varying Multi-Rate Tracking Controllers”

Duarte Antunes, ISR/IST PhD student

March 2008

“The Origins of Robust Control in the 1970’s”

Prof. Michael Safonov, University of Southern California

March 2008

“Robust Adaptive Fault-Tolerant Control using RMMAC/FDI architecture and its application to the F-14 Aircraft under Sensor Failures”

Dr. Sajjad Fekri, University of Leicester

March 2008

“Towards the Quantification of Functional Brain Imaging Measurements”

Patrícia Figueiredo, Department of Physics, IST

April 2008

“A Virtual Rider for Motorcycles: An Approach Based on Optimal Control and Maneuver Regulation”

Prof. Alessandro Saccon, University of Padova, Italy

April 2008

“An Overview of Aiding Techniques for USBL/INS Underwater Navigation Systems”

Marco Morgado, ISR/IST PhD student

April 2008

“Filter Design with Secrecy Constraints”

Miguel Rodrigues, Faculdade de Ciências da Universidade do Porto

April 2008

“ANSIG - An Analytic Signature for 2D Shape Representation”

José Jerónimo Rodrigues, ISR/IST MSc student

April 2008

“Hypergraph-Based Detection of Anomalous Interactions in Very Large Networks”

Jorge Gomes Silva and Rebecca Willett, Dept. of Electrical and Computer Engineering, Pratt School of Engineering, Duke University

May 2008

“Decoding LDPC Codes with Faulty Iterative Decoders”

Lav R. Varshney, Massachusetts Institute of Technology

May 2008

“Fault detection and self-assembly in swarms of robots”

Anders Christensen

June 2008

“Low Order Control Design: The H₂ Design by Non-smooth, Non-convex Optimization

Dr. Wojciech Kozinski, Institute for Control and Industrial Electronics, Warsaw University of Technology

July 2008

“Towards a Theory of Cascaded Detectors”

Prof. Jim Rehg, Associate Professor, Georgia Institute of Technology, USA

September

“Advanced flight control for VTOL UAV using Image-based control paradigm”

Tarek Hamel, I3S UNSA-CNRS6, Sophia Antipolis

October 2008

“Gradient like observers for invariant systems”

Robert Mahony, Department of Engineering, Australian National University

October 2008

“Visual Homing based on Optical-Flow Techniques and Applications to Autonomous Robot Cleaning”

Lorenz Gerstmayr, Computer Engineering Group, Bielefeld University, Germany

October 2008

“Algebra, Software, and Signal Processing”

Prof. Markus Pueschel, Electrical and Computer Engineering, CMU

November 2008

- “Brown Bag” seminars on Control Theory (organized by Prof. M. Athans)

2.4.3 Visits Abroad

Jorge S. Marques

- Computer Vision Center, Prof. Juan Jose Villanueva, Universidade Autonoma de Barcelona, February, 2008.

Dynamical Systems and Ocean Robotics Lab

Several visits abroad in the scope of long standing cooperation links that include the following:

- Department of Mechanical Engineering and Aeronautics, Naval Postgraduate School, Monterey, CA (USA) – a long standing collaborative research program on AUV and UAV NGC, as well as multiple vehicle control.
- Center for Control, Dynamical Systems, and Computation (CCDC) at University of California, Santa Barbara, CA (USA) – joint work on control, estimation theory, and networked control systems.
- National Institute of Oceanography (NIO), Goa (India) – an intensive research and development program was initiated in 1999, leading to the development of the MAYA AUV.

- Department of Engineering Cybernetics, Norwegian University of Science and Technology (NTNU), Trondheim (Norway) - exchange of students and research personnel; joint work on cooperative path following control.
- University of Girona, Institute of Informatics and Applications, Escola Politècnica Superior, Girona (Spain) – joint theoretical and practical work on Mission Control Systems for autonomous underwater vehicles.
- Dept. Electrical and Computer Engineering, University of Maryland (USA) – exchange of research personnel and joint initiatives on Networked Control Systems.
- Dept. Mechanical Engineering, John Hopkins University, Baltimore (USA) – exchange of research personnel and joint initiatives on Underwater Navigation Systems.

2.4.4 Reading Groups

VisLab weekly seminar meeting.

2.4.5 Supervision of Students Enrolled in Foreign Universities

Alexandre Bernardino

- Supervisor of Giovanni Saponaro, M.Sc student from Università di Roma La Sapienza, Italy, (March September 2008), ERASMUS.

Margarida Silveira

- Supervisor of Tatjana Wunderlich, TU Muchen, Germany – 3 month period at ISR/IST, September to December 2008.

Pedro Lima

- Supervisor of Valdinei Silva, Ph.D. Student from Universidade Politécnica de São Paulo, Brasil.

2.5 CONGRESS, MEETINGS AND PRESENTATIONS

This section includes invited talks, conferences attended and conferences where papers were presented, during 2008, by ISR-Lisbon researchers.

2.5.1 Invited Talks

António Aguiar

- “Minimum Energy and H-infinity Estimation: Application to Systems with Implicit Outputs”, NTNU, Trondheim, Norway, November 2008.

António Pascoal

- “Multiple Vehicle Path Generation and Cooperative Path Following with Spatial and Temporal Constraints”, NTNU, Trondheim, Norway, October 2008.

Carlos Silvestre

- UAV developments under the HELICIM and OBSERVFLY Projects, French Research Group in Robotics, GDR-Robotique, ENSAM Paris, Oct. 2008.
- “Mission and Vehicle Control of Aerial and Marine Vehicles”, UCSB – CCDC, Spring 2008 Seminar Series, UCSB USA, May 2008.

Manuel Lopes

- “How and Where to Grasp”, invited talk, IROS Workshop: Robotics Challenges for Machine Learning II, September, 2008.

Pedro Lima

- “A Systems Theory Approach to Cooperative Robotics and Sensor Networks”, invited talk, IROS2008 Network Robot Systems Workshop, Nice, France, September 2008.
- “A Multidisciplinary Approach to Cooperative Robotics”, invited talk, DISALab at EPFL, Lausanne, Switzerland, November 2008.

2.5.2 Participations

CVPR 2008 – IEEE Conference on Computer Vision and Pattern Recognition, Anchorage AK, USA, June, 2008.

ACOUSTICS 2008 – European Conference on Underwater Acoustics (ECUA) and European Conference on Noise Control (Euronoise), Paris, France, July 2008.

SPAWC 2008 - 9th IEEE International Workshop on Signal Processing Advances in Wireless Communications, Recife, Brazil, July 2008.

EMBS 2008 - 30th Annual International Conference of the IEEE Engineering in Medicine and Biology Society, Vancouver, Canada, August 2008.

EUSIPCO 2008 – 16th European Signal Processing Conference, Lausanne, Switzerland, August 2008.

OCEANS 2008 – MTS/IEEE Conference on Oceanic Engineering, Quebec City, Canada, September 2008.

GNSS 2008 – 21ST International Technical Meeting of the Satellite Division of the Institute of Navigation, Savannah, Georgia, September 2008.

ICIP 2008 – IEEE International Conference on Image Processing, San Diego CA, USA, October 2008.

4th ESA Workshop on Satellite Navigation User Equipment Technologies, December 2008.

2.6 SERVICE ACTIVITIES

This section is dedicated to service activities developed, during 2008, by ISR-Lisbon researchers as members of the national and international scientific community.

2.6.1 Editorial Boards

Agostinho Rosa

- Member of the Editorial Board of the International Journal of Information & Communication Technology in Education.

António Pascoal

- Associate Editor, IEEE Oceanic Engineering.

Jorge S. Marques

- Associate Editor of Statistics and Computing Journal, Springer.

José Santos-Victor

- Associate Editor, IEEE Transactions on Robotics, until September 2008.

Pedro Lima

- Member of the Editorial Advisory Board of Journal of Advanced Robotic Systems, published by ARS Publishing, Vienna.
- Member of the Editorial Board of the Portuguese Magazine Robótica.

2.6.2 Advisory Boards

Agostinho Rosa

- Member of AWBL – Advances in Web Based Learning Book Series – (2007-2009).

António Pascoal

- Vice-President of EurOcean, the European Portal for Marine Science and Technology.

José Santos-Victor

- Member of the Aurora Board of Participants of the European Space Agency (ESA).

2.6.3 Programme and Technical Committees

Agostinho Rosa

- Member of the IFAC TC – Optimal Control.
- Member of the IASTED TC – Biomedical Engineering.

Alexandre Bernardino

- Program Committee Member, EPIROB 2008 - International Workshop on Epigenetic Robotics.
- Program Committee Member, ICIAR2008 - International Conference on Image Analysis and Recognition.

António Pascoal

- Member of the Technical Program Committee, The 18th International Offshore (Ocean) and Polar Engineering Conference & Exhibition, Vancouver, British Columbia, Canada, July 6-11, 2008.
- Member of the Technical Program Committee, V Jornadas Argentinas de Robótica JAR'08 (The 5th Argentine Robotics Workshop), Bahía Blanca, Argentina, 12-14 November, 2008.
- Member of the Technical Program Committee, NGCUV'08 - IFAC Workshop on Navigation, Guidance and Control of Underwater Vehicles, Killaloe, Ireland, Apr. 2008.
- Chair, IFAC Technical Committee on Marine Systems.
- Member of the IFAC Technical Committee on Intelligent Autonomous Vehicles.
- Organizer of the workshop on "Cooperative Control of Multiple Autonomous Vehicles" for the 17th IFAC World Congress, Seoul, Korea, July 2008. Cooperative Control of Multiple Autonomous Vehicles. This workshop focused on the theme of Cooperative Control of Multiple Autonomous Vehicles, with applications to underwater vehicles, surface craft, wheeled mobile robots, and aircraft.
- Organizer of the special session on "Cooperative Motion Control of Multiple Autonomous Vehicles" for the 17th IFAC World Congress, Seoul, Korea, July 2008.

Carlos Silvestre

- Member of the IFAC Technical Committee on Aerospace.
- Member of the IEEE Technical Committee on Aerospace Control.
- Associated Editor of the MSC-CCA 2008, IEEE Multi-conference on Systems and Control, IEEE International Conference on Control Applications (CCA), September 3-5, 2008, San Antonio, Texas (USA).

Jacinto C. Nascimento

- Member of the Technical Program Committee of the IEEE Int. Conf on Image Processing, San Diego CA, USA, October 2008.

João Pedro Gomes

- Member of the Technical Program Committee of the 2nd International Conference on Sensor Technologies and Applications (SENSORCOMM), Cap Esterel, France, August 2008.
- Member of the Technical Program Committee of the International Workshop on Underwater Networks (WUWNET), San Francisco, California, USA, September 2008.
- Member of the Technical Program Committee of the OCEANS 2008 MTS/IEEE, Quebec City, Canada, September 2008.

João Sanches

- Elected for Associate Member of the BISP (Bio Imaging and Signal Processing) Technical Committee of the IEEE Signal Processing Society in 2008/7.
- Member of the Technical Program Committee of the IEEE International Conference on Acoustics, Speech, and Signal Processing (ICASSP) 2008.
- Member of the Technical Program Committee of the Iberoamerican Conference on Pattern Recognition (CIARP), September 9-12, Havana, Cuba, 2008.
- Member of the Technical Program Committee of the Conference of the IEEE Engineering in Medicine and Biology Society - EMBC 2008.
- Member of the Technical Program Committee of the International Conference on Image Analysis and Recognition - ICIAR 2008.

Jorge S. Marques

- Member of the Program Committee of IBERAMIA 2008, Lisbon, October 2008.

- Member of the Program Committee of VIIP'08 Visualization, Imaging and Image Processing, Palma de Maiorca, September, Spain, 2008.

José Gaspar

- Program Committee Member, Workshop on Omnidirectional Robot Vision (held with SIMPAR 2008) http://monicareggiani.net/simpar2008/index.php?option=com_content&task=view&id=26&Itemid=34

José Santos-Victor

- Program Committee Member, ICRA 2008 - IEEE International Conference on Robotics and Automation.
- Program Committee Member, CVPR 2008 - IEEE Computer Society Conference on Computer Vision and Pattern Recognition.
- Program Committee Member, IROS 2008 - IEEE International Conference on Intelligent Robots and Systems.
- Program Committee Member, RSS 2008 - Robotics Systems and Science.

Luis Montesano

- Robotics: Science and Systems

Manuel Lopes

- Robotics: Science and Systems
- International Conference on Development and Learning

Matthijs Spaan

- AAMAS 2008 - 7th International Conference on Autonomous Agents and Multi-Agent Systems, Estoril, Portugal, May 2008.
- UAI 2008 - 24th Conference on Uncertainty in Artificial Intelligence, Helsinki, Finland, July 2008.
- AAAI 2008 - 23rd Conference on Artificial Intelligence, Chicago, Illinois, USA, July 2008.
- ICAPS 2008 - 18th International Conference on Automated Planning and Scheduling, Sydney, Australia, September 2008.

Paulo Oliveira

- Member of the Technical Committee of the 8th Conference on Mobile Robots and Competitions, Castelo Branco, April 2008.

Pedro Aguiar

- Member of the Technical Program Committee of the IEEE International Conference on Image Processing, San Diego CA, USA, October 2008.

Pedro Lima

- ECAI 2008 – 18th European Conference on Artificial intelligence, Patras, Greece, July 2008.
- RoboCup Symposium 2008, Suzhou, China, July 2008.
- IROS 2008 – IEEE/RSJ International Conference on Intelligent Robots and Systems, Nice, France, September 2008.
- SIMPAR 2008 - International Conference on Simulation, Modeling, and Programming for Autonomous Robots, Venice, Italy, November 2008.

Rui Dinis

- Member of the Technical Program Committee of the Wireless Communications Symposium of IEEE ICC'08 (International Conference on Communications).

- Member of the Technical Program Committee of the Wireless Communications Symposium of IEEE GLOBECOM'08 (Global Telecommunications Conference).

2.6.4 Chairperson

António Pascoal

- Chair of the session "Marine System I", 2008 IFAC World Congress, Seoul, Korea, July 2008.
- Chair of the session "Marine System II", 2008 IFAC World Congress, Seoul, Korea, July 2008.
- Chair of the session "Nonlinear Observers II", 2008 IFAC World Congress, Seoul, Korea, July 2008.
- Chair of the session "Cooperative Motion Control of Multiple Autonomous Vehicles", 2008 IFAC World Congress, Seoul, Korea, July 2008.

Carlos Silvestre

- Co-Chair of the session "Low Altitude Flight and Landing Control", 2008 IFAC World Congress, Seoul, Korea, July 2008.

Paulo Oliveira

- Co-Chair of the session "Kalman Filtering", 2008 IFAC World Congress, Seoul, Korea, July 2008.

2.6.5 Reviewers

Agostinho Rosa

- IEEE Transaction of Circuits and Systems for Video Technology.
- BSPC Biomedical Signal Processing & Control.
- IEEE Transaction of Biomedical Engineering.
- Clinical Neurophysiology.
- International Journal of Imaging and Graphics.
- ACHI 2008 - The International Conference on Advances in Computer-Human Interactions.
- BioMed 2008 - The 6th IASTED International Conference on Biomedical Engineering.
- SAC 2008 – The 23rd Annual ACM Symposium on Applied Computing.
- ICEIS 2008 - 10th International Conference on Enterprise Information Systems.
- ICINCO 2008 – The 5th International Conference on Informatics in Control, Automation and Robotics.

Alexandre Bernardino

- Autonomous Robots, Springer Netherlands.
- International Journal on Humanoid Robot, World Scientific.
- IEEE Transactions on Image Processing.
- IEEE Transaction on Robotics.
- ECCV 2008 - European Conference on Computer Vision.
- EPIROB 2008 - The International Workshop on Epigenetic Robotics.
- ICIAR 2008 - International Conference on Image Analysis and Recognition.
- ICRA 2008 - IEEE International Conference on Robotics and Automation.

António Pascoal, Carlos Silvestre, Paulo Oliveira, and António Aguiar – reviewers for a large number of journals and conferences that include:

- IEEE Automatic Control, AUTOMATICA
- IEEE Oceanic Engineering
- IEEE Control Systems Technology
- International Journal of Robust and Nonlinear Control
- ACC 2008 - American Control Conference
- CDC 2008 - IEEE Conference on Decision and Control
- IFAC World Conference 2008
- NGCUV 2008 - Navigation, Guidance, and Control of Unmanned Vehicles

Carlos Bispo

- European Journal of Operational Research

Jacinto C. Nascimento

- IEEE Transactions on Image Processing
- Computer Vision Image Understanding
- IEEE Transactions on Systems, Man and Cybernetics, Part B
- IEEE Transactions on Circuits and Systems for Video Technology

João Pedro Gomes

- IEEE Journal on Selected Areas in Communications.
- IEEE Journal of Oceanic Engineering.
- Journal of the Acoustical Society of America.
- IET Electronics Letters.
- IEEE International Symposium on Personal.
- Indoor and Mobile Radio Communications (PIMRC'08).
- Third ACM International Workshop on UnderWater Networks (WUWNet'08).
- MTS/IEEE Oceans'08.

João Sanches

- IEEE Transaction of Biomedical Engineering
- IEEE Transaction of Image Processing

João Xavier

- IEEE Transactions on Signal Processing

José Gaspar

- CVIU, Computer Vision and Image Understanding, Journal, Elsevier.
- ICRA 2008 - IEEE International Conference on Robotics and Automation.
- IROS 2008 - IEEE/RSJ International Conference on Intelligent Robots and Systems.
- SIMPAR 2008 - International Conference on Simulation, Modeling and Programming for Autonomous Robots.
- Workshop on Omnidirectional Robot Vision (held with SIMPAR).

José Santos-Victor

- IEEE Transactions on Pattern analysis and Machine Intelligence.
- IEEE Transactions on Robotics and Automation.
- IEEE Transactions on Biomedical Engineering.

- IEEE Transactions on Robotics.
- IEEE Transactions on System Man and Cybernetics.
- Journal of Robotics and Autonomous Systems.
- BMVC 2008 - British Machine Vision Conference.
- IBPRIA 2008 - Iberian Conference on Pattern Recognition and Image Analysis.
- ICRA 2008- IEEE International Conference on Robotics and Automation.
- IROS 2008 - IEEE/RSJ International Conference on Intelligent Robots and Systems.

Luis Montesano

- IEEE Transactions on Robotics.
- ICRA 2008 - IEEE International Conference on Robotics and Automation.
- IROS 2008 - IEEE International Conference on Intelligent Robots and Systems.
- RSS 2008 - Robotics: Science and Systems.
- IJCAI 2008 -International Joint Conference on Artificial Intelligence.

Manuel Lopes

- IEEE Transactions on Robotics.
- International Jornal on Robotics Research.
- ICRA 2008 - IEEE International Conference on Robotics and Automation.
- IROS 2008 - IEEE International Conference on Intelligent Robots and Systems.
- RSS 2008 - Robotics: Science and Systems.
- ICDL 2008 - International Conference on Development and Learning.

Margarida Silveira

- Pattern Recognition Letters
- Pattern Recognition

Matthijs Spaan

- Journal of Artificial Intelligence Research (JAIR).
- Autonomous Agents and Multi-Agent Systems (JAAMAS).
- Neurocomputing.
- IEEE Transactions on Systems, Man and Cybernetics, part B.
- ICAPS 2008 - 18th International Conference on Automated Planning and Scheduling.
- UAI 2008 - 24th Conference on Uncertainty in Artificial Intelligence.
- AAAI 2008 - 23rd Conference on Artificial Intelligence.
- AAMAS 2008 - 7th International Conference on Autonomous Agents and Multi-Agent Systems.
- IFAC World Congress 2008.
- ECAI 2008 - European Conference on Artificial intelligence.
- IAS 2008 - 10th International Conference on Intelligent Autonomous Systems.

Pedro Aguiar

- IEEE Transactions on Pattern Analysis and Machine Intelligence.
- IEEE Transactions on Image Processing.
- KLUWER International Journal of Computer Vision.

Pedro Lima

- IEEE Transactions on Systems, Man and Cybernetics, part B
- IEEE Transactions on Robotics
- CASE 2008 - 4th Annual IEEE Conference on Automation Science and Engineering.
- ECAI 2008 - European Conference on Artificial intelligence.

- ICRA 2008 - IEEE International Conference on Robotics and Automation
- IROS 2008 - IEEE/RSJ International Conference on Intelligent Robots and Systems
- RoboCup Symposium 2008.
- SIMPAR 2008 - International Conference on Simulation, Modeling, and Programming for Autonomous Robots.
- IFAC World Congress 2008.

Rodrigo Ventura

- Neurocomputing
- ECAI 2008 - European Conference on Artificial intelligence.
- ICRA 2009 - IEEE International Conference on Robotics and Automation.

2.6.6 Other Activities

Agostinho Rosa

- Evaluation and review expert for EU Information Society and Technology Program – PE – TC.
- 1st course of CAP, Universidade Autonoma do Mexico (UAM), June 2008.
- “Polisonografia”, Master Course in Science of Sleep, IMM-FMUL.

António Pascoal

- Member of the evaluation panel of the PhD grants financed by Fundação para a Ciência e a Tecnologia (FCT), 2008.
- Member of Scientific Evaluation Panels of AdI.

Carlos Silvestre

- Member of scientific evaluation panels of AdI.

Hans du Buf

- Associate Editor of the International Journal of Pattern Recognition and Artificial Intelligence.

José Santos-Victor

- IST, Vice President for International Affairs.

Matthijs Spaan

- Co-organizer of “Multiagent Planning Workshop” at ICAPS 2008, Sydney, Australia, in September 2008. Other organizers: Brad Clement (NASA Jet Propulsion Laboratory), Mathijs de Weerd (Delft University of Technology), and Shlomo Zilberstein (University of Massachusetts at Amherst).

Paulo Oliveira

- Member of scientific evaluation panels of AdI.

Pedro Lima

- Member of the Board of Trustees of the RoboCup Federation.
- President of the Specialized Committee of the Portuguese Society of Robotics for the Portuguese Robotics Open (*Festival Nacional de Robótica*).
- Invited scientist for the European project GAPP (Gender Awareness Participation Process), as responsible by the “Blogue do Cientista”, close to 2 high school classes in Portugal.

- Co-organizer (with Chris Rogers, TUFTS University, EUA, and Aaron Dollar, MIT, USA) and speaker of the Workshop “Teaching with Robots”, within Robotics: Science and Systems, 2008.

Pedro Lima and Matthijs Spaan

- Co-organizers workshop on “Formal Models and Methods for Multi-Robot Systems” at AAMAS 2008, in Estoril, Portugal. Other organizers were Nikos Vlassis (Technical University of Crete) and Francisco Melo (Carnegie Mellon University).

2.7 ACADEMIC ACTIVITIES

Here we list the participation, during 2008, of ISR-Lisbon researchers in committees for Doctoral and Master Theses, and other academic related activities.

Agostinho Rosa

- Member of the M.Sc. Thesis Committee of Nuno Fachada, “LAIS, Agent-based Simulator for Artificial Immune System”, Instituto Superior Técnico, Universidade Técnica de Lisboa, June 2008.
- Member of the M.Sc. Thesis Committee of António Rorodrigues, “Agent based model of fission-fusion of the bat”, Instituto Superior Técnico, Universidade Técnica de Lisboa, Sep. 2008.
- Member of the M.Sc. Thesis Committee of Inês Freitas, “Prediction of fatigue using EMG”, Instituto Superior Técnico, Universidade Técnica de Lisboa, Dec. 2008.
- Member of the M.Sc. Thesis Committee of Nuno Alberto L.R. Rocha, “Ligacoes preferenciais por proximidade e semelhança em redes de processamento de informação”, ISCTE/FCUL, Dec. 2008.

Alexandre Bernardino

- Member of the Ph.D Thesis Committee of Plinio Moreno López, “Object component models using Gabor filters for visual recognition,” Ph.D. Thesis, Instituto Superior Técnico, Lisbon, Portugal, September 2008

Carlos Bispo

- Member of the Ph.D Thesis Committee of Ricardo Raposo Oliveira, “Optimal Multi-Frame Correspondence with Assignment Tensors”, Instituto Superior Técnico, Universidade Técnica de Lisboa, 2008.

Carlos Silvestre

- Coordinator, Graduate Studies, Scientific Area of Systems, Decision, and Control.

Hans du Buf

- Member of the Ph.D. Thesis Committee of Fitsum Admasu, “Stochastic geometric methods for Automated 3D seismic image analysis”, University of Magdeburg (Germany) 2008.

João Sanches

- Member of the Ph.D. Thesis Committee of Rui Rocha, “Image Segmentation and Reconstruction of 3D Surfaces from Carotid Ultrasound Images” (Adviser: Prof. Aurélio Campilho, FEUP, Porto).
- Member of the M.Sc. Thesis Committee of Nuno Filipe Maia Lucas, “Kit de Apoio à Aprendizagem de Sinais, Circuitos e Sistemas Electrónicos”, Instituto Superior Técnico, Universidade Técnica de Lisboa, 2008 (Advisers: José Gaspar and João Sequeira).
- Member of the M.Sc. Thesis Committee of André Duarte, “Implementação de Middleware genérico no CODAC do ISTTOK” (Adviser: Horácio Fernandes).

- Member of the M.Sc. Thesis Committee of Daniel Filipe Valcárcel, “Controlo em Tempo-Real da Posição da Coluna de Plasma no Tokamak ISTTOK” (Adviser: Bernardo Brotas de Carvalho).

João Xavier

- Member of the Ph.D. Thesis Committee of Miguel Barão, Advisor: Prof. João Miranda Lemos, Instituto Superior Técnico, Universidade Técnica de Lisboa, 2008.

Jorge S. Marques

- Member of the Ph.D. Thesis Committee of Miguel Barão, “Métodos de Controlo Probabilístico” IST, September 2008.
- Member of the Ph.D. Thesis Committee of Vera Afreixo, “Sinais Simbólicos e Aplicações em Genómica”, Universidade de Aveiro, 2008.
- Member of the Ph.D. Thesis Committee of Hugo Monteiro, “Neural and Hybrid Methods for estimation and Classification, Faculdade de Engenharia da Universidade do Porto, October 2008.
- Member of the M.Sc. Thesis Committee of Daniela Sousa, “Seguimento de Movimento Humano Usando Visão Computacional”, Faculdade de Engenharia da Universidade do Porto, 2008.
- Member of the M.Sc. Thesis Committee of Miguel Buchinho Pontos, “Alinhamento Deformável de Imagens com aplicação a mapas de doses em radioterapia”, IST, October 2008.
- Member of the M.Sc. Thesis Committee of Miguel Venâncio, Alinhamento de Imagens Médicas 2D e 3D, October 2008.
- Member of the M.Sc. Thesis Committee of Pedro Pires, “Activity characterization from actimetry sensor data for sleep disorders diagnosis, November 2008.

José Santos-Victor

- Member of the Ph.D. Thesis Committee of Fernando Monteiro, “Region Based Spatial and Temporal Image Segmentation”, Fernando Jorge Coutinho Monteiro, Faculdade de Engenharia da Universidade do Porto, March 2008.
- Member of the Ph.D. Thesis Committee of Micha Hersch, “Adaptive sensorimotor peripersonal space representation and motor learning for a humanoid robot”, École Polytechnique Fédérale de Lausanne (EPFL), December 2008.
- Member of the Ph.D Thesis Committee of Plinio Moreno López, “Object component models using Gabor filters for visual recognition,” Ph.D. Thesis, Instituto Superior Técnico, Lisbon, Portugal, September 2008.

José Gaspar

- Member of the Ph.D Thesis Committee of Nuno Gonçalves, “Noncentral Catadioptric Systems with Quadric Mirrors: Geometry and Calibration,” Ph.D. Thesis, Faculdade de Ciências e Tecnologia da Universidade de Coimbra, Coimbra, Portugal, October 2008.

Paulo Oliveira

- Member of the Executive Board of the Department of Electrical Engineering and Computers (IST).

Pedro Lima

- Member of the Ph.D Thesis Committee of Jorge Miguel de Paiva Pinheiro Pais, “A Teoria Projectiva Multidimensional e a Arquitectura NdimProA para Raciocínio Espacial Qualitativo”, Departamento de Engenharia Electrotécnica e de Computadores, Instituto Superior Técnico, Universidade Técnica de Lisboa, 2008.
- Member of the Ph.D Thesis Committee of Caetano Filipe Costa de Noronha Ferreira, “Autonomous Navigation and Multi- Sensorial Real-Time Localization for a Mobile Robot”, Departamento de Engenharia Mecânica, Universidade de Aveiro, 2008.

- Member of the Ph.D Thesis Committee of James Pugh, “Synthesis, Modeling, and Exploration of Distributed Robotic Search”, School of Architecture, Civil and Environmental Engineering, École polytechnique Fédérale de Lausanne, 2008.
- Member of the M.Sc. Thesis Committee of Pedro Miguel Figueiredo Gomes, “Sistema de Controlo para Seguimento de Costa com Aplicação a Catamarãs Autónomos”, Instituto Superior Técnico, Universidade Técnica de Lisboa, 2008.
- Member of the M.Sc. Thesis Committee of Hugo Miguel Gomes da Silva, “Sistema de Visão em Tempo Real para Sistemas Autónomos”, Instituto Superior Técnico, Universidade Técnica de Lisboa, 2008.

Rodrigo Ventura

- Member of the M.Sc. Thesis Committee of Fausto Ferreira, “RAPOSA: Robot Autónomo Para Operações de Salvamento”, Instituto Superior Técnico, Universidade Técnica de Lisboa, 2008.
- Member of the M.Sc. Thesis Committee of Artur Prego, “Desenvolvimento e Análise de Comportamentos Relacionais em Robots Futebolistas”, Instituto Superior Técnico, Universidade Técnica de Lisboa, 2008.
- Member of the M.Sc. Thesis Committee of Luís Carlos Machado Santos, “iCat e O jogo das Letras”, Instituto Superior Técnico, Universidade Técnica de Lisboa, 2008.
- Member of the M.Sc. Thesis Committee of Dario Bacellar, “A Cognitive Architecture for Humanoid Social Robots - Spatial Environment Model”, Instituto Superior Técnico, Universidade Técnica de Lisboa, 2008.
- Member of the M.Sc. Thesis Committee of Cristina Aleixo, “A receptionist robot: navigation and image processing”, Instituto Superior Técnico, Universidade Técnica de Lisboa, 2008.
- Member of the M.Sc. Thesis Committee of Manuel Malhado, “A receptionist robot: interface and coordination”, Instituto Superior Técnico, Universidade Técnica de Lisboa, 2008.
- Member of the M.Sc. Thesis Committee of Bruno Filipe Simão Dias, “Automatic Music Transcription”, Instituto Superior Técnico, Universidade Técnica de Lisboa, 2008.
- Member of the M.Sc. Thesis Committee of Samuel Ferreira, “PREDTRACK - Predição de Trajectórias de Alvos Móveis”, Instituto Superior Técnico, Universidade Técnica de Lisboa, 2008.

2.8 VISITS TO ISR

2.8.1 Distinguished Visitors

- Alcherio Martinoli, “A Multi-Level Modeling Methodology for Swarm Robotic Systems”, 12 May, 2008.
- Magnus Egerstedt, “Graph-Based Control of Heterogeneous Robot Networks”, 12 May, 2008.
- Juan J Merello – University of Granada, Spain.
- Prof. Cecilia Laschi, Scuola Superiore Satnanna, Italy.
- Prof. Luciano Fadiga, University of Ferrara.
- Prof. Francisco Lacerda, University of Stockholm.
- Prof. Alberto Sanfeliu, Universidad Politecnica de Cataloni.
- Prof. Fabrizio Smeraldi, Queen Mary College, University of London.
- Dr. Jan Peters, MPI for BiologicalCybernetics, Tübingen, Germany.
- Dr. Marcel Brass, University of Ghent, Belgium.
- Prof. Nando de Freitas, University of British Colombia, Canada.

2.9 SPECIAL EVENTS

2.9.1 “From Human Societies to Artificial Societies”

Lisbon, Portugal
April 7 – July 7, 2008

Organizers: Dr. Porfírio Silva, Prof. Pedro Lima

Laboratory: Intelligent Systems

Description: Under the Institutional Robotics ISR project, this conference cycle was organized to bring to ISR/IST a set of researchers from different areas of knowledge (Economists, Philosophers, Biologists, Neuroscientists), so as to shed light over topics more or less closely related to collective robotics, and clarify the different ontologies on related subjects. The conference cycle was open to general audiences and widely advertised in Lisbon and Portugal.

WEB: <http://institutionalrobotics.wordpress.com/>

PROGRAM:

- 7 April – “Economia, Instituições e Sociedades Artificiais” (“Economics, Institutions, and Artificial Societies”), by José M. Castro Caldas, Centro de Estudos Sociais, Faculdade de Economia, University of Coimbra (commentator: Carlos Bispo, ISR/IST).
- 28 April – “O cérebro em acção - interacção com o ambiente” (“The brain in action-interaction with the environment”), by Fernando Lopes da Silva, Professor Emérito de Fisiologia, Centro de Neurociências, University of Amsterdam (commentator: José Santos Victor, ISR/IST).
- May – “Ontologia e Epistemologia. Pensar o realismo” (“Ontology and Epistemology, Questions to Realism”) by, João Paulo Monteiro, Professor Catedrático Aposentado de Filosofia, Universidade de S. Paulo, Instituto de Filosofia da Linguagem, New University of Lisbon (commentator: Rodrigo Ventura, ISR/IST).
- 28 May – “Como as células constroem um corpo sem terem um plano” (“ How cells build a body without a plan”), by Jorge Carneiro, Instituto Gulbenkian de Ciência, Laboratório Associado de Oeiras (commentator: Joaquim Sampaio Cabral, IST, Instituto de Biotecnologia e Bioengenharia).
- 16 May – “Para uma Ecologia dos Ambientes Institucionais” (“Towards na Ecology of Institutional Environments”), by, Viriato Soromenho-Marques, Departamento de Filosofia, FL, University of Lisbon (commentator: Paulo Ferrão, IN+ , Programa MIT-Portugal).
- 7 July – “Engenharia das Sociedades Artificiais e Engenharia das Sociedades Humanas” (“Engineering Artificial Societies, Emgineering Human Societies”), by Pedro U. Lima, Instituto de Sistemas e Robótica, IST (commentator: Porfírio Silva).

2.9.2 CAS 2008 – Curso de Acústica Submarina 2008

Faro, Portugal
12 – 15 May, 2008

Coordinator: Orlando Camargo Rodríguez.

Laboratories: SiPLAB.

Support: ISR.

Description: O curso (de nível pós-graduação) destinou-se a licenciados desempenhando funções de investigação ou tarefas ligadas ao mar, nas suas vertentes de observação, intervenção ou estudo nas áreas da biologia marinha, engenharia electrotécnica, oceanografia e geofísica. Destinou-se igualmente a oficiais da marinha com interesse nas áreas das tecnologias, sistemas electrónicos submarinos de vigilância ou tácticas de defesa. O curso teve uma duração de 32 horas efectivas, distribuídas ao longo de 4 dias, incluindo sessões teóricas, sessões práticas com simulação em computador e incluiu uma saída de mar, durante a qual os participantes tiveram a oportunidade de assistir e participar numa mini-campanha de aquisição de dados acústicos, que foram analisados no último dia do curso.

URL: <http://www.siplab.fct.ualg.pt/cas/programa.html>

2.9.3 GREX Trials

Azores, Portugal Summer of 2008

Organized jointly by the IMAR/DOP/UAzores and the ISR/IST, the first series of GREX sea trials took place at HORTA, Faial, during the Summer of 2008. Considerable progress was made towards bringing together the different modules for multiple vehicle control of ATLAS (Ger), SEEBYTE (UK), IFREMER (FR), IST (PT), and ORANGE ENERGY (PT). *The tests witnessed the integration of the communication, decision, and control modules developed by the partners followed by transition from the laboratory to the water and the successful execution of multiple vehicle missions.*



The EU GREX TRIALS: the project partners in the Azores

2.10 Awards

Has du Buf

- CERATONIA (Caixa Geral de Depósitos) Award: "The Amateur Painter: da percepção da imagem à pintura artificial", December 2008.

José Jerónimo Rodrigues

- Prize L. Vidigal for the best M. Sc. Thesis of IST on the scientific areas of Electrical Engineering and Computer Science.

Manuel Marques

- Best Student Presentation Award, IEEE International Conference on Automatic Face and Gesture Recognition 2008 – Amsterdam, The Netherlands.

Pedro Aguiar, João Xavier, Marko Stosic

- DoCoMo USA Labs Innovative Paper Award. Paper: "Globally optimal solution to exploit rigidity when recovering structure from motion under occlusion", IEEE International Conference on Image Processing ICIP'08, S. Diego CA, USA, October 2008.

2.11 PUBLICATIONS

a) M.Sc. Theses (38)

- [1] **Ricardo Daniel Rita Beira**, “Mechanical Design of an Anthropomorphic Robot Head,” Master Thesis, Instituto Superior Técnico, Lisbon, Portugal, January 2008.
- [2] **Pedro Fazenda**, “Non-Holonomic Robot Formations with Obstacle Compliant Geometry”, Master Thesis, Instituto Superior Técnico, Lisbon, Portugal, January 2008.
- [3] **André Bianchi Figueiredo**, “Sistema de Controlo de um Veículo Autónomo Aéreo”, Master Thesis, Instituto Superior Técnico, Lisbon, Portugal, January 2008.
- [4] **Nuno Fachada**, “LAIS: Agent Based Simulator for Artificial Immune System”, Master Thesis, Instituto Superior Técnico, Lisbon, Portugal, June 2008.
- [5] **Pedro Daniel Correia Pires**, “Activity Characterization from Actimetry Sensor Data for Sleep Disorders Diagnosis”, Master Thesis, Instituto Superior Técnico, Lisbon, Portugal, September 2008.
- [6] **Isabela Maria Montenegro da Silva**, “Toward a fully automatic left ventricle segmentation using cine-MR images”, Master Thesis, Instituto Superior Técnico, Lisbon, Portugal, September 2008.
- [7] **José Santos**, “A Baroreflex Control Model Using Head-Up Tilt Test”, Master Thesis, Instituto Superior Técnico, Lisbon, Portugal, September 2008.
- [8] **Joana Coelho**, “Joint Detection-Estimation of Brain Activity in fMRI using Graph Cuts”, Master Thesis, Instituto Superior Técnico, Lisbon, Portugal, September 2008.
- [9] **José J. Rodrigues**, “ANSIG - an Analytic Signature for Permutation Invariant Shape Representation”, Master Thesis, Instituto Superior Técnico, Lisbon, Portugal, September 2008.
- [10] **David Jerónimo**, “Passarola: Dirigível Autónomo para Operações de Salvamento (Electrónica)”, Master Thesis, Instituto Superior Técnico, Lisbon, Portugal, September 2008.
- [11] **Ricardo Alcácer**, “Passarola: Dirigível Autónomo para Operações de Salvamento (Robótica)”, Master Thesis, Instituto Superior Técnico, Lisbon, Portugal, September 2008.
- [12] **João Messias**, “Task Specific Motion Control of Omnidirectional Robots”, Master Thesis, Instituto Superior Técnico, Lisbon, Portugal, September 2008.
- [13] **Francisco Mendonça**, “Smooth Priorities”, Master Thesis, Instituto Superior Técnico, Lisbon, Portugal, October 2008.
- [14] **Pedro Afonso**, “Railway Traffic Management”, Master Thesis, Instituto Superior Técnico, Lisbon, Portugal, October 2008.
- [15] **Artur Prego**, “Desenvolvimento e Análise de Comportamentos Relacionais em Robots Futebolistas”, Master Thesis, Instituto Superior Técnico, Lisbon, Portugal, October 2008.

- [16] **Fausto Ferreira**, “RAPOSA: Robot Autónomo para Operações de Salvamento”, Master Thesis, Instituto Superior Técnico, Lisbon, Portugal, October 2008.
- [17] **Dario Bacellar**, “From Pixels to Objects - Enabling a spatial model for humanoid social robots”, Master Thesis, Instituto Superior Técnico, Lisbon, Portugal, October 2008.
- [18] **Cristina Aleixo**, “A receptionist robot: navigation and image processing”, Master Thesis, Instituto Superior Técnico, Lisbon, Portugal, October 2008.
- [19] **Manuel Malhado**, “A receptionist robot: interface and coordination”, Master Thesis, Instituto Superior Técnico, Lisbon, Portugal, October 2008.
- [20] **Samuel António Tojal Ferreira**, “Predtrack - Predição de Alvos Móveis: Aplicação ao Controlo de uma Cabeça Robótica,” Master Thesis, Instituto Superior Técnico, Lisbon, Portugal, November 2008.
- [21] **Daniela Filipa Gonçalves Pamplona**, “Gaussian Foveation,” Master Thesis, Instituto Superior Técnico, Lisbon, Portugal, November 2008.
- [22] **Nuno Filipe Maia Lucas**, “Ekit - Kit de Apoio à Aprendizagem de Sinais, Circuitos e Sistemas Electrónicos,” Master Thesis, Instituto Superior Técnico, Lisbon, Portugal, November 2008.
- [23] **Bruno Filipe Simão Dias**, “Automatic Transcription of Musical Whistling,” Master Thesis, Instituto Superior Técnico, Lisbon, Portugal, November 2008.
- [24] **João Santos**, “Multi-Robot Cooperative Object Localization: Decentralized Bayesian Approach”, Master Thesis, Instituto Superior Técnico, Lisbon, Portugal, December 2008.
- [25] **Giovanni Saponaro**, “Object Manipulation from Simplified Visual Cues”, Master Thesis, Università di Roma La Sapienza, 2008.
- [26] **João Mota**, “Distributed Algorithms for Sparse Reconstruction”, Master Thesis, Instituto Superior Técnico, Lisbon, Portugal, 2008.
- [27] **Augusto Santos**, “Subspace Segmentation”, Master Thesis, Instituto Superior Técnico, Lisbon, Portugal, 2008.
- [28] **Pedro Guerreiro**, “Linear Discriminant Analysis Algorithms”, Master Thesis, Instituto Superior Técnico, Lisbon, Portugal, 2008.
- [29] **Miguel dos Santos Venâncio**, “2D and 3D medical imaging registration”, Master Thesis, Instituto Superior Técnico, Lisbon, Portugal, 2008.
- [30] **Pedro Gomes**, “Coastline-following Preview Controller for the Delfimx Vehicle”, Master Thesis, Instituto Superior Técnico, Lisbon, Portugal, 2008.
- [31] **Sérgio Brás**, “Pose Observers for Unmanned Air Vehicles”, Master Thesis, Instituto Superior Técnico, Lisbon, Portugal, 2008.

- [32] **Miguel Leitão**, “Nonlinear Flight Control: Dynamic Inversion Based Control of Aircraft Pitch”, Master Thesis, Instituto Superior Técnico, Lisbon, Portugal, 2008.
- [33] **Joana Gomes**, “Multiple model underwater tracking systems”, Master Thesis, Instituto Superior Técnico, Lisbon, Portugal, 2008.
- [34] **Emílio Pereira**, “Robust Nonlinear Motion Control for Multiple Autonomous Robotic Vehicles”, Master Thesis, Instituto Superior Técnico, Lisbon, Portugal, 2008.
- [35] **Tiago Gaspar**, “Indoor Target Tracking Vision Systems”, Master Thesis, Instituto Superior Técnico, Lisbon, Portugal, 2008.
- [36] **Renato Sousa**, “Advanced Marine Vehicles Target Trackers”, Master Thesis, Instituto Superior Técnico, Lisbon, Portugal, 2008.
- [37] **Luís Gomes**, “Advanced Signal Processing Techniques for Integrated Navigation Systems”, Master Thesis, Instituto Superior Técnico, Lisbon, Portugal, 2008.
- [38] **CHAN Chun-Ni**, “Advanced NAVSTAR-GPS Positioning Techniques for UAVs”, Master Thesis, Imperial College of London, UK, 2008.

b) Ph.D. Theses (4)

- [39] **Rodrigo Ventura**, “Emotion-based Mechanisms for Decision Making in Autonomous Agents”, Ph.D. Thesis, Instituto Superior Técnico, Lisbon, Portugal, January 2008.
- [40] **Marko Beko**, “Non-Coherent Communication in Multiple-Antenna Systems: Receiver Design, Codebook Construction and Capacity Analysis”, Ph.D. Thesis, Instituto Superior Técnico, Lisbon, Portugal, February 2008.
- [41] **João Rodrigues**, “Integrated multi-scale architecture of the cortex with application to computer vision”, Ph.D. Thesis, University of Algarve, Faro, Portugal, February 2008.
- [42] **Plinio Moreno López**, “Object component models using Gabor filters for visual recognition,” Ph.D. Thesis, Instituto Superior Técnico, Lisbon, Portugal, September 2008.

c) In Books (6)

- [43] **J. S. Marques, J. Nascimento, A. Abrantes, M. Silveira**, “Robust Shape Estimation with Deformable Models”, in *Advances in Computational Vision and Medical Image Processing: Methods and Applications*, Springer, invited paper, 57-76, 2008.
- [44] **R. C. Martins, V. V. Lopes, A. A. Vicente, and J. A. Teixeira**, “Numerical solutions - finite element and finite volume methods”, *Optimization in Food Engineering*, Ferruh Erdogdu (Ed.), Chapter 1.4, pp. 49-108, 2008.

- [45] **C. Fernandes, A. Rosa**, “Evolutionary Algorithms with Dissortative Marting in Static and Dynamic Environments”, in *Evolutionary Algorithms*, Witold Kosinski (Edt), Ch. 10, pp. 181-206, ISBN 978-3-902613-32-5. ARS Press, Vienna, Austria.
- [46] **A. M. Mora, C. M. Fernandes, J. J. Merelo, V. Ramos, J. L. Laredo, A. C. Rosa**, “KohonAnts: A Self-Organizing Ant Algorithm for Clustering and Pattern Classification”, *ALIFE XI*, pp. 428-435, 2008, MIT Press.
- [47] **J. L. Laredo, P. A. Castillo, A. M. Mora, J. J. Merelo, A. Rosa, C. Fernandes**, “Evolvable Agents in Static and Dynamic Optimization Problems”, PPSN, *Lectures Notes in Computer Sciences 5199*, Springer-Verlag, ISBN 978-3-540-87699-1, pp. 488-497, 2008.
- [48] **C. Fernandes, A. M. Mora, J. J. Merelo, V. Ramos, J. L. Laredo, A. Rosa**, “KANTS: Artificial Ant System for Classification”, ANTSI08, *Lectures Notes in Computer Science, Vol 5217*, Springer-Verlag, ISBN 978-3-3540-87256-1 pp 339-346. <http://dx.doi.org/10.1007/978-3-540-87527-735>.

d) In International Journals (29)

- [49] **F. Oliehoek, M. Spaan, N. Vlassis**, “Optimal and Approximate Q-value Functions for Decentralized POMDPs”, *Journal of Artificial Intelligence Research*, Vol. 32, pp. 289-353, 2008.
- [50] **B. Lacerda, P. Lima**, “Linear-Time Temporal Logic Control of Discrete Event Models of Cooperative Robots”, *Journal of Physical Agents*, Vol. 2, No. 1, Special Issue on Multi-Robot Systems, 2008.
- [51] **P. Moreno, A. Bernardino and J. Santos-Victor**, “Improving the SIFT descriptor with smooth derivative filters”, *Pattern Recognition Letters*, Vol. 30 (1) 2008.
- [52] **L. Montesano, J. Minguez, L. Montano**, “Modeling Dynamic Scenarios for Local Sensor-Based Motion Planning”, *Autonomous Robots*, Vol. 25(3) 2008.
- [53] **L. Montesano, M. Lopes, A. Bernardino, J. Santos-Victor**, “Learning Object Affordances: From Sensory Motor Maps to Imitation”, *IEEE Transactions on Robotics*, Special Issue on Bio-Robotics, Vol. 24(1) Feb 2008.
- [54] **J. Nascimento, M. A. T. Figueiredo, J. S. Marques**, “Independent Increment Processes for Human Motion Recognition”, *Computer Vision and Image Understanding*, 109, 126–138, 2008.
- [55] **J. Sanches, J. Nascimento, J. S. Marques**, “Medical Image Noise Reduction using the Sylvester-Lyapunov Equation”, *IEEE Transactions on Image Processing*, vol. 17, 1522-1539, September 2008.
- [56] **J. Nascimento, J. S. Marques**, “Robust Shape Tracking with Multiple Models in Ultrasound Images”, *IEEE Transactions on Image Processing*, vol. 17, 392-406, March 2008.
- [57] **P. M. Q. Aguiar, M. Stosic, and J. Xavier**, “On Singular Values of Partially Prescribed Matrices”, *ELSEVIER Linear Algebra and its Applications*, vol. 429, 8-9, October 2008.

- [58] **J. Gomes, A. Silva, S. Jesus**, "Adaptive spatial combining for passive time-reversed communications", *Journal of the Acoustical Society of America*, vol. 124, no. 2, pp. 1038-1053, August 2008.
- [59] **J. Gomes, V. Barroso**, "Array-based QR-RLS multichannel lattice filtering", *IEEE Transactions on Signal Processing*, vol. 56, no. 2, pt. 1, pp. 3510-3522, August 2008.
- [60] **N. Martins, C. Soares, S. Jesus**, "Environmental and Acoustic Assessment: the AOB concept", *Journal of Marine Systems*, vol. 69, pp. 114-125, January 2008.
- [61] **J. A. Martins, J. Rodrigues, J. M. H. du Buf**, "Multi-scale lines and edges in V1 and beyond: brightness, object categorization and recognition, and consciousness", *BioSystems*, vol. 95, pp. 206-226, 2008.
- [62] **M. Beko, J. Xavier and V. Barroso**, "Further results on the capacity and error probability analysis of non-coherent MIMO systems in the low SNR regime", *IEEE Transactions on Signal Processing*, vol. 56, no. 7, pp. 2915 - 2930, July 2008.
- [63] **R. Dinis and A. Gusmão**, "Nonlinear Signal Processing Schemes for OFDM Modulations within Conventional or LINC Transmitter Structures", *European Trans. on Telecomm*, 2008.
- [64] **P. Silva and R. Dinis**, "A Turbo SDMA Receiver for Strongly Nonlinearly Distorted MC-CDMA Signals", *Canadian Journal of Electrical and Computer Engineering*, 2008.
- [65] **M. Silva, A. Correia and R. Dinis**, "Interference Suppression Consisting of Pre-distortion Filtering and Selective Transmit Diversity", *Wireless Personal Communications*, Springer, 2008.
- [66] **A. Aguiar, J. Hespanha, and P. Kokotović**, "Performance Limitations in Reference Tracking and Path-Following for Nonlinear Systems", *IFAC Automatica*, Vol. 44, No. 3, pp. 598-610, March 2008.
- [67] **R. Cunha, C. Silvestre, J. Hespanha**, "Output-feedback control for stabilization on SE(3)", *Elsevier Systems and Control Letters*, Volume 57, Issue 12, pp. 1013-1022, December 2008.
- [68] **J. Vasconcelos, M. Athans, S. Fekriasl, C. Silvestre, P. Oliveira**, "Stability-and Performance-Robustness Tradeoffs: MIMO Mixed-mu vs Complex-mu Designs", *International Journal of Robust and Nonlinear Control*, February 2008, DOI: 10.1002/rnc.1299.
- [69] **A. Aguiar, J. Hespanha, and P. V. Kokotović**, "Zero Dynamics and Tracking Performance Limits in Nonlinear Feedback Systems", In *Analysis and Design of Nonlinear Control Systems*, Astolfi, Alessandro; Marconi, Lorenzo (Eds.), Springer Verlag Berlin, 2008.
- [70] **C. Fernandes, A. Rosa**, "Self-Adjusting the Intensity of Assortative Mating in Genetic Algorithms", *Journal of Soft Computing*, 12(10), pp. 955-979, 2008.
- [71] **R. C. Martins, V. V. Lopes, A. A. Vicente, and J. A. Teixeira**, "Computational shelf-life dating: complex systems approaches to food quality and safety", *Food and Bioprocess Technology, An International Journal*, 1(3):207-222, 2008.

- [72] **R. C. Martins, V. V. Lopes, and A. A. Vicente**, “Sistemas computacionais para a previsão da qualidade e segurança alimentar: evolução e sistemas complexos”, *Ingenium*, 104:57-60, 2008.
- [73] **C. Munteanu, F. Cabrera, and A. C. Rosa**, “Enhancing Obstetric and Gynecology Ultrasound Images by Adaptation of the Speckle Reducing Anisotropic Diffusion Filter”, *Artificial Intelligence in Medicine*, 43, pp. 223-242, 2008.
- [74] **M. C. Lopes, C. Guilleminault, A. Rosa, C. Passarelli, S. Roizenblat, S. Tufik**, “Delta Sleep Instability in children with chronic arthritis”, *Brazilian Journal of Medical and Biological Research*, 41:938-943, 2008.
- [75] **R. C. Martins, V. V. Lopes, P. Valentão, B. M. Silva, J. C. M. F. Carvalho, P. Amaral, M. T. Batista, M. R. Seabra, and P. B. Andrade**, “Relevant principal component analysis applied to the characterization of Portuguese heather honey”, *Natural Product Research* (In Press).
- [76] **R. C. Martins, R. Oliveira, F. Bento, D. Geraldo, V. V. Lopes, P. Guedes de Pinho, C. M. Oliveira, and A. C. Silva Ferreira.**, “Oxidation management of white wines using cyclic voltammetry and multivariate process monitoring”, *Journal of Agricultural and Food Chemistry* (In Press).
- [77] **C. M. Fernandes**, “Pherographia: Drawing by Ants”, *Leonardo* (accepted).

e) In International Conferences (123)

- [78] **D. Almeida, S. Nunes, J. Carvalho, V. Brito, J. Rodrigues, J.M.H. Du Buf**, “Fine arts edutainment: the amateur painter”, *Proc. of GRAPP 2008 - the International Conference on Computer Graphics, Theory and Applications*, pp. 262-267, Funchal Portugal, January 2008.
- [79] **M. Marques, J. Costeira**, “Optimal shape from motion estimation with missing and degenerate data”, *Proc. of WACV 2008 - IEEE Workshop on Application of Computer Vision*, Copper Mountain, CO, USA, January 2008.
- [80] **J. Fayad, A. Del Bue, P. Aguiar**, “Articulated motion analysis from motion capture data”, *Proc. of CMBBE 2008 - International Symposium on Computer Methods in Biomechanics and Biomedical Engineering*, Porto, Portugal, February 2008.
- [81] **D. Afonso, J. Sanches, M. H. Lauterbach**, “Joint Bayesian Detection of Brain Activated Regions and HRF Estimation in Functional MRI”, *Proc. of ICASSP 2008 - IEEE International Conference on Acoustics, Speech, and Signal Processing*, Las Vegas, Nevada, USA, March 2008.
- [82] **J. Sequeira**, “Measuring motion expressiveness in wheeled mobile robots”, *Proc. of EUROS 2008 - European Robotics Symposium*, Prague, Czech Republic, March 2008.
- [83] **R. Dinis, C. Lam and D. Falconer**, “Joint Frequency-Domain Equalization and Channel Estimation using Superimposed Pilots”, *Proc. of WCNC 2008 – IEEE Wireless Communications & Networking Conference*, Las Vegas, USA, March-April 2008.

- [84] **N. Souto, R. Dinis, J. Silva and P. Carvalho**, "A High Throughput Technique for OFDM Systems", *Proc. of WCNC 2008 – IEEE Wireless Communications & Networking Conference, Las Vegas, USA, March-April 2008*.
- [85] **N. Souto, A. Correia, R. Dinis, J. Silva, L. Abreu**, "Multiresolution MBMS Transmissions for MIMO UTRA LTE systems", *Proc. of BTS 2008 - IEEE International Symposium on Broadband Multimedia Systems and Broadcasting, Las Vegas, USA, March-April 2008*.
- [86] **J. Leitner, A. Bernardino and J. Santos-Victor**, "A Benchmark on Stereo Disparity Estimation for Humanoid Robots", *Proc. of Robotica 2008 - 8th Conference on Autonomous Robot Systems and Competitions, Aveiro, Portugal, April 2008*.
- [87] **B. Tworek, A. Bernardino, J. Santos-Victor**, "Visual Self-Calibration of Pan-Tilt Kinematic Structures", *Proc. of Robotica 2008 - 8th Conference on Autonomous Robot Systems and Competitions, Aveiro, Portugal, April 2008*.
- [88] **N. M. Hagenfeldt, A. Karlsson, J. Sequeira**, "An Alternative Metrology Concept: Ray Trace Ranging", *Proc. of the 3rd International Symposium on Formation Flying, Missions and Technologies, ESA/ESTEC, Noordwijk, The Netherlands, April 2008*.
- [89] **F. Teixeira, A. Pascoal**, "Geophysical Navigation of Autonomous Underwater Vehicles Using Geomagnetic Information", *Proc. of NGCUV 2008 - IFAC Workshop on Navigation, Guidance and Control of Underwater Vehicles, Killaloe, Ireland, April 2008*.
- [90] **F. Vanni, A. Aguiar, A. Pascoal**, "Cooperative Path-Following of Underactuated Autonomous Marine Vehicles with Logic-based Communication", *Proc. NGCUV 2008 - IFAC Workshop on Navigation, Guidance and Control of Underwater Vehicles, Killaloe, Ireland, April 2008*.
- [91] **J. Vasconcelos, G. Elkaim, C. Silvestre, P. Oliveira, B. Carneira**, "A Geometric Approach to Strapdown Magnetometer Calibration in Sensor Frame", *Proc. of NGCUV 2008 - IFAC Workshop on Navigation, Guidance & Control of Underwater Vehicles, Killaloe, Ireland, April 2008*.
- [92] **F. Vanni, A. Aguiar, A. Pascoal**, "Cooperative Path-Following of Underactuated Autonomous Marine Vehicles with Logic-based Communication", *Proc. of NGCUV 2008 - IFAC Workshop on Navigation, Guidance and Control of Underwater Vehicles, Killaloe, Ireland, April 2008*.
- [93] **F. Melo, I. Ribeiro**, "Reinforcement learning with function approximation for cooperative navigation tasks", *Proc. of ICRA 2008 - IEEE International Conference on Robotics and Automation, Pasadena, CA, USA, May 2008*.
- [94] **J. Ruesch, M. Lopes, A. Bernardino, J. Hornstein, J. Santos-Victor, R. Pfeifer**, "Multimodal Saliency-Based Bottom-Up Attention A Framework for the Humanoid Robot iCub", *Proc. of ICRA 2008 - IEEE International Conference on Robotics and Automation, Pasadena, CA, USA, May 2008*.
- [95] **F. Melo, I. Ribeiro**, "Emerging coordination in infinite team Markov games", *Proc. of AAMAS 2008 - 7th International Conference on Autonomous Agents and Multi-agent Systems, Estoril, Portugal, May 2008*.

- [96] **N. Lopes, P. Lima**, "OpenSDK - An Open-source Implementation of OPEN-R", *Proc. of AAMAS 2008 - 7th International Joint Conference on Autonomous Agents and Multi-Agent Systems*, Estoril, Portugal, May 2008.
- [97] **H. Costelha, P. Lima**, "Modelling, Analysis and Execution of Multi-Robot Tasks using Petri Nets", *Proc. of AAMAS 2008 - 7th International Joint Conference on Autonomous Agents and Multi-Agent Systems*, Estoril, Portugal, May 2008.
- [98] **V. Ziparo, L. Iocchi, P. Palamara, H. Costelha, D. Nardi**, "PNP: A Formal Model for Representation and Execution of Multi-Robot Plans", *Proc. of AAMAS 2008 - 7th International Joint Conference on Autonomous Agents and Multi-Agent Systems*, Estoril, Portugal, May 2008.
- [99] **F. Oliehoek, M. Spaan, S. Whiteson, N. Vlassis**, "Exploiting Locality of Interaction in Factored Dec-POMDPs", *Proc. of AAMAS 2008 - the 7th International Conference on Autonomous Agents and Multiagent Systems*, Estoril, Portugal, May 2008.
- [100] **M. Spaan, F. Melo**, "Interaction-Driven Markov Games for Decentralized Multiagent Planning under Uncertainty", *Proc. of AAMAS 2008 - the 7th International Conference on Autonomous Agents and Multiagent Systems*, Estoril, Portugal, May 2008.
- [101] **P. Silva, R. Ventura, P. Lima**, "Institutional Environments, Proc. of Workshop AT2AI: From agent theory to agent implementation", *Proc. Of AAMAS 2008 - 7th International Conference on Autonomous Agents and Multiagent Systems*, Estoril, Portugal, May 2008.
- [102] **G. Neto, P. Lima**, "Combining Supervisory Control of Discrete Event Systems and Reinforcement Learning to Control Multi-Robot Systems", *Proc. of Workshop Formal models and methods for multi-robot systems, AAMAS 2008 - the 7th International Conference on Autonomous Agents and Multiagent Systems*, Estoril, Portugal, May 2008.
- [103] **A. F. Martins, P. Aguiar, and M. A. T. Figueiredo**, "Tsallis kernels on measures", *Proc. of ITW 2008 - IEEE Information Theory Workshop*, Porto, Portugal, May 2008.
- [104] **T. Araújo and R. Dinis**, "Analytical Evaluation of Nonlinear Distortion Effects on OFDMA Uplink Signals", *Proc. of VTC 2008 (Spring) - IEEE 67th Vehicular Technology Conference*, Singapore, May 2008.
- [105] **C. Fernandes, J. Merelo, A. Rosa**, "Tracking Extrema in Dynamic Fitness Landscapes with Dissortative Mating Genetic Algorithm", *Proc. of HIS 2008 - 8th International Conference on Hybrid Intelligent Systems*, Barcelona, Spain, pp. 59-64, May 2008.
- [106] **A. Khmelinskii, R. Ventura, J. Sanches**, "Chromosome Pairing for Karyotyping Purposes using Mutual Information", *Proc. of ISBI 2008 - 5th IEEE International Symposium on Biomedical Imaging: From Nano to Macro*, Paris, France, May 2008.
- [107] **M. Silveira, J. S. Marques**, "Level set segmentation of dermoscopy images", *Proc. of ISBI 2008 - 5th IEEE International Symposium on Biomedical Imaging: From Nano to Macro*, Paris, France, May 2008.

- [108] **D. Afonso, J. Sanches and M. H. Lauterbach**, “fMRI Brain Activity and Underlying Hemodynamics Estimation in a New Bayesian Framework”, *Proc. of ISBI 2008 – 5th IEEE International Symposium on Biomedical Imaging: From Nano to Macro*, Paris, France, May 2008.
- [109] **L. Caldeira and J. Sanches**, “Liver Tumor Assessment with DCE-MRI”, *Proc. of ISBI 2008 – 5th IEEE International Symposium on Biomedical Imaging: From Nano to Macro*, Paris, France, May 2008.
- [110] **A. Khmelinskii, R. Ventura and J. Sanches**, “Chromosome Pairing for Karyotyping Purposes using Mutual Information”, *Proc. of ISBI 2008 – 5th IEEE International Symposium on Biomedical Imaging: From Nano to Macro*, Paris, France, May 2008.
- [111] **J. Sanches, D. Afonso, K. Bartnykas and M. H. Lauterbach**, “Comparison of Two Different Approaches for Brain Activity Detection in fMRI: SPM-Bayesian and SPM-GLM”, *Proc. of ISBI 2008 – 5th IEEE International Symposium on Biomedical Imaging: From Nano to Macro*, Paris, France, May 2008.
- [112] **P. Figueiredo and J. Sanches**, “Sampling Strategy for Perfusion Quantification using PASL-MRI”, *Proc. of ISBI 2008 – 5th IEEE International Symposium on Biomedical Imaging: From Nano to Macro*, Paris, France, May 2008.
- [113] **P. Serra, R. Cunha, C. Silvestre**, “On the Design of Rotorcraft Landing Controllers”, *Proc. of MED 2008 - 16th Mediterranean Conference on Control and Automation*, Ajaccio, Corsica, France, June 2008.
- [114] **J. J. Rodrigues, P. Aguiar, and J. Xavier**, “ANSIG — an analytic signature for permutation-invariant two-dimensional shape representation”, *Proc. of CVPR 2008 - IEEE Conference on Computer Vision and Pattern Recognition*, Anchorage, Alaska, USA, June 2008.
- [115] **P. Aguiar, M. Stosic, and J. Xavier**, “Spectrally optimal factorization of incomplete matrices”, *Proc. of CVPR 2008 - IEEE Conference on Computer Vision and Pattern Recognition*, Anchorage, Alaska, USA, June 2008.
- [116] **N. Silva, J. Costeira**, “Subspace Segmentation with Outliers: a Grassmannian approach to the maximum consensus subspace”, *Proc. of CVPR 2008 - IEEE Computer Society Conference on Computer Vision and Pattern Recognition*, Anchorage, Alaska, USA, June 2008.
- [117] **L. Caldeira and J. Sanches**, “Pharmacokinetic Perfusion Curves Estimation for Liver Tumor Diagnosis from DCE-MRI”, *Proc. of ICIAR 2008 - International Conference on Image Analysis and Recognition*, Póvoa de Varzim, Portugal, June 2008.
- [118] **P. F. Palamara, V. A. Ziparo, L. Iocchi, D. Nardi, P. Lima**, “Teamwork Design Based on Petri Net Plans”, *Proc. of RoboCup International Symposium*, Suzhou, China, July 2008.
- [119] **A. Aguiar, I. Kaminer, R. Ghabcheloo, A. Pascoal, E. Xargay, N. Hovakimyan, C. Cao, V. Dobrokhodov**, “Coordinated Path Following of Multiple UAVs for Time-Critical Missions in the Presence of Time-Varying Communication Topologies”, *Proc. of the 17th IFAC World Congress*, Seoul, Korea, July 2008.

- [120] **A. Aguiar, V. Hassani, A. Pascoal, and M. Athans**, "Identification and Convergence Analysis of a Class of Continuous-Time Multiple-Model Adaptive Estimators", *Proc. of the 17th IFAC World Congress*, Seoul, Korea, July 2008.
- [121] **J. Almeida, C. Silvestre, A. Pascoal**, "Compliant coordination and control of multiple vehicles with discrete-time periodic communications", *Proc. of 17th IFAC World Congress*, Seoul, South Korea, July 2008.
- [122] **D. Antunes, C. Silvestre, R. Cunha**, "Linear Parameter Varying Control for Sampled-Data Multi-Rate Systems", *Proc. of 17th IFAC World Congress*, Seoul, South Korea, July 2008.
- [123] **P. Batista, C. Silvestre, P. Oliveira**, "Kalman and H Infinity Optimal Filtering for a Class of Kinematic Systems", *Proc. of 17th IFAC World Congress*, Seoul, South Korea, July 2008.
- [124] **P. Batista, C. Silvestre, P. Oliveira**, "Position and Velocity Navigation Filters for Marine Vehicles", *Proc. of 17th IFAC World Congress*, Seoul, South Korea, July 2008.
- [125] **B. Guerreiro, C. Silvestre, R. Cunha**, "Terrain Avoidance Model Predictive Control for Autonomous Rotorcraft", *Proc. of 17th IFAC World Congress*, Seoul, South Korea, July 2008.
- [126] **M. Morgado, P. Oliveira, C. Silvestre, J. Vasconcelos**, "Improving Aiding Techniques for USBL Tightly-Coupled Inertial Navigation System", *Proc. of 17th IFAC World Congress*, Seoul, South Korea, July 2008.
- [127] **N. Palomeras, P. Ridao, M. Carreras, C. Silvestre**, "Towards a Mission Control Language for AUVs", *Proc. of 17th IFAC World Congress*, Seoul, South Korea, July 2008.
- [128] **J. Vasconcelos, C. Silvestre, P. Oliveira**, "A Nonlinear Observer for Rigid Body Attitude Estimation Using Vector Observations", *Proc. of 17th IFAC World Congress*, Seoul, South Korea, July 2008.
- [129] **J. Gomes, A. Silva, S. Jesus**, "Experimental assessment of time-reversed OFDM underwater communications", *Proc. of ACOUSTICS 2008*, Paris, France, July 2008.
- [130] **S. Jesus, C. Soares, N. Martins**, "Water column tomographic inversion with a network of drifting buoys", *Proceedings of ACOUSTICS 2008*, Paris, France, July 2008.
- [131] **J.C. Legac, J-P. Hermand, S. M. Jesus**, "Medium frequency (800-1600Hz) geoacoustic inversions with drifting sparse arrays during the MREA/BP'07 experiment", *Proc. of ACOUSTICS 2008*, Paris, France, July 2008.
- [132] **M. Beko, J. Xavier and V. Barroso**, "Low SNR analysis of the non-coherent MIMO channel under arbitrary channel and noise correlation structures", *Proc. of SPAWC 2008 - IEEE International Conference on Signal Processing Advances in Wireless Communications*, Recife, Brasil, July 2008.
- [133] **R. Oliveira, L. Bernardo, P. Pinto and R. Dinis**, "A Load-adaptive Timeout for Beaconing-based Link Protocols in Ad Hoc Networks", *Proc. of EW 2008 – European Wireless Conference, Prague, Czech Republic*, July 2008.

- [134] **C. Fernandes, C. Lima, A. Rosa**, "UMDA for Dynamic Optimization Problems", *Proc of GECCO 2008 – Genetic and Evolutionary Computation Conference*, Atlanta, Georgia, USA, pp .399-406, July 2008.
- [135] **C. Fernandes, J. Merello, V. Ramos, A. Rosa**, "A Self-organized Criticality Mutation operator for Dynamic Optimization Problems", *Proc of GECCO 2008 – Genetic and Evolutionary Computation Conference*, Atlanta, Georgia, USA, pp. 937-944, July 2008.
- [136] **C. Lima, C. Fernandes**, "Investigating Restricted Tournament Replacement in ECGA for Non-Stationary Environments", *Proc of GECCO 2008 – Genetic and Evolutionary Computation Conference*, Atlanta, Georgia, USA, pp. 439-446, July 2008.
- [137] **A. F. Martins, M. A. T. Figueiredo, P. Aguiar, N. A. Smith, and E. P. Xing**, "Nonextensive entropic kernels", *Proc. of ICML 2008 - International Conference on Machine Learning*, Helsinki, Finland, July 2008.
- [138] **F. Melo, I. Ribeiro, S. P.Meyn**, "An analysis of reinforcement learning with function approximation", *Proc. of ICML 2008 - International Conference on Machine Learning*, Helsinki, CA, Finland, July 2008.
- [139] **N. Gonçalves, J. Sequeira**, "Modeling Robot Behaviors With Hybrid Automata", *Proc. of Control 2008 - 8th Portuguese Conference on Automatic Control*, Vila Real, Portugal, July 2008.
- [140] **M. Spaan**, "Cooperative Active Perception using POMDPs", *Proc. of AAAI 2008 Workshop on Advancements in POMDP Solvers*, Chicago, USA, July 2008.
- [141] **A. Ahmad**, "Probabilistic Roadmap Method and Real Time Gait Changing Technique Implementation for Travel Time Optimization on a Designed Six-legged Robot", *Proc. of ISR 2008 - 39th International Symposium on Robotics*, Seoul, South Korea, July 2008.
- [142] **A. Aguiar, I. Kaminer, R. Ghabcheloo, A. Pascoal, E. Xargay, N. Hovakimyan, C. Cao, V. Dobrokhodov**, "Time-Coordinated Path Following for Multiple UAVs using Dynamic Networking and L1 Adaptation", *Proc. of GN&C 2008 - AIAA Guidance, Navigation and Control Conference*, Honolulu, Hawaii, August 2008.
- [143] **N. Monteiro, J. Gomes, J. Xavier**, "Detection of statistical periodicities in DNA by conflict and entropy minimization methods", *Proc. of EUSIPCO 2008 – 16th European Signal Processing Conference*, Lausanne, Switzerland, August 2008.
- [144] **J. Rodrigues, D. Almeida, J. A. Martins, R. Lam, J. M. H. du Buf**, "An integrated framework for combining gist vision with object segregation, categorisation and recognition", *Proc. of ECVP 2008 - 31th European Conference on Visual Perception*, Utrecht, The Netherlands, August 2008.
- [145] **J. M. H. du Buf, J. Rodrigues**, "Brightness perception: one simple model explains most if not all effects", *Proc. of ECVP 2008 - 31th European Conference on Visual Perception*, Utrecht, The Netherlands, vol. 37, p. 62, August 2008.
- [146] **R. Dinis, P. Montezuma and J. Martins**, "Soft Combining ARQ Techniques for Wireless Systems Employing SC-FDE Schemes", *Proc. of ICCCN 2008 – 17th International Conference on Computer Communications and Networks*, St. Thomas, USA, August 2008.

- [147] **M. Silveira, P. Aguiar**, "Simultaneous Registration and Intensity Normalization of SPECT Perfusion Images", *Proc. of EMBS 2008 - 30th Annual International Conference of the IEEE Engineering in Medicine and Biology Society*, Vancouver, British Columbia, Canada, August 2008.
- [148] **J. Nascimento, J. Sanches**, "Total Variation with automatic hyper-parameter estimation", *Proc. of EMBS 2008 - 30th Annual International Conference of the IEEE Engineering in Medicine and Biology Society*, Vancouver, British Columbia, Canada, August 2008.
- [149] **I. Rodrigues, J. Sanches**, "Temporal 2D Reconstruction of Cell Nucleus from Fluorescence Confocal Microscopy Images with Anisotropic Filtering", *Proc. of EMBS 2008 - 30th Annual International Conference of the IEEE Engineering in Medicine and Biology Society*, Vancouver, British Columbia, Canada, August 2008.
- [150] **J. Coelho, J. Sanches, M. H. Lauterbach**, "fMRI Binary Detection of Brain Activated Regions with Graph-Cuts", *Proc. of EMBS 2008 - 30th Annual International Conference of the IEEE Engineering in Medicine and Biology Society*, Vancouver, British Columbia, Canada, August 2008.
- [151] **A. Khmelinskii, R. Ventura, J. Sanches**, "Automatic Chromosome Pairing Using Mutual Information", *Proc. of EMBS 2008 - 30th Annual International Conference of the IEEE Engineering in Medicine and Biology Society*, Vancouver, British Columbia, Canada, August 2008.
- [152] **J. Seabra, J. Xavier, J. Sanches**, "Convex Ultrasound Image Reconstruction with Log-Euclidean Priors", *Proc. of EMBS 2008 - 30th Annual International Conference of the IEEE Engineering in Medicine and Biology Society*, Vancouver, British Columbia, Canada, August 2008.
- [153] **I. Rodrigues, J. Xavier, J. Sanches**, "Fluorescence Confocal Microscopy Imaging Denoising with Photobleaching", *Proc. of EMBS 2008 - 30th Annual International Conference of the IEEE Engineering in Medicine and Biology Society*, Vancouver, British Columbia, Canada, August 2008.
- [154] **J. Seabra, J. Sanches**, "Three-dimensional labeling of vulnerable regions in carotid plaques using Graph-Cuts", *Proc. of EMBS 2008 - 30th Annual International Conference of the IEEE Engineering in Medicine and Biology Society*, Vancouver, British Columbia, Canada, August 2008.
- [155] **J. Seabra, J. Sanches**, "Modeling Log-Compressed Ultrasound Images for Radio Frequency Signal Recovery", *Proc. of EMBS 2008 - 30th Annual International Conference of the IEEE Engineering in Medicine and Biology Society*, Vancouver, British Columbia, Canada, August 2008.
- [156] **A. Khmelinskii, R. Ventura, J. Sanches**, "Automatic Chromosome Pairing Using Mutual Information", *Proc. of EMBC 2008 - 30th Annual International Conference of the IEEE Engineering in Medicine and Biology Society*, Vancouver, British Columbia, Canada, August 2008.
- [157] **V. Kronic, G. Salvi, A. Bernardino, L. Montesano, J. Santos-Victor**, "Associating word descriptions to learned manipulation task models", *Proc. of IROS 2008 Workshop on Grasp and Task Learning by Imitation*, Nice, France, September 2008.
- [158] **M. Lopes, F. S. Melo, B. Kenward and J. Santos-Victor**, "A computational model for social learning mechanisms", *Proc. of IROS 2008 Workshop - From motor to interaction learning in robots*, Nice, France, September 2008.

- [159] **J. Hörnstein, L. Gustavsson, J. Santos-Victor and F. Lacerda**, "Modeling Speech imitation", *Proc. of IROS 2008 Workshop - From motor to interaction learning in robots*, Nice, France, September 2008.
- [160] **J. Sequeira**, "The URUS Project", *Proc. of EuroTRUSTAmI 2008 - 2nd European Workshop on European Research towards Trusted Ambient intelligence*, Sophia-Antipolis, France, September 2008.
- [161] **J. Gomes, A. Silva, S. Jesus**, "OFDM Demodulation in Underwater Time-Reversed Shortened Channels", *Proc. of MTS/IEEE OCEANS 2008*, Quebec, Canada, September 2008.
- [162] **S. Jesus, O. C. Rodríguez**, "A time-reversal suboptimal detector for underwater acoustic barriers", *Proc. of MTS/IEEE OCEANS 2008*, Quebec, Canada, September 2008.
- [163] **L. Gomes, P. Oliveira**, "Bathymetric Data Fusion: PCA based Interpolation and Regularization, Sea Tests, and Implementation", *Proc. of MTS/IEEE OCEANS 2008*, Quebec, Canada, September 2008.
- [164] **R. Sousa, A. Alcocer, P. Oliveira, R. Ghabcheloo, A. Pascoal**, "Joint Positioning and Navigation Aiding System for Underwater Robots", *Proc of MTS/IEEE OCEANS 2008*, Quebec, Canada, September 2008.
- [165] **M. Taiana, J. Nascimento, J. Gaspar, A. Bernardino**, "Sample-Based 3D Tracking of Colored Objects: A Flexible Architecture", *Proc. of BMVC 2008 - The British Machine Vision Conference*, vol. 2, pp. 825-834, University of Leeds, Leeds, UK, September 2008.
- [166] **M. Taiana, J. Nascimento, J. Gaspar and A. Bernardino**, "Sample-Based 3D Tracking of Colored Objects: A Flexible Architecture", *Proc. of BMVC 2008 - British Machine Vision Conference*, Leeds, UK, September 2008.
- [167] **N. Delgado, F. Nunes and J. Xavier**, "A geometrical approach for maximum likelihood estimation of multipath", *Proc. of ION GNSS 2008 – 21st International Technical Meeting of the Satellite Division of The Institute of Navigation*, Savannah, September 2008.
- [168] **M. Silva, A. Correia and R. Dinis**, "On Pre-Processing for MIMO W-CDMA", *Proc. of WPMC 2008 – 11th International Symposium on Wireless Personal Multimedia Communications*, Lapland, Finland, September 2008.
- [169] **J. Silva, R. Dinis and N. Souto**, "Efficient Channel Estimation for Iterative MIMO SC-FDE Systems", *Proc. of VTC 2008 (Fall) – IEEE 68th Vehicular Technology Conference*, Calgary, Canada, September 2008.
- [170] **M. Marques, J. Costeira**, "3D face recognition from multiple images: a shape-from-motion approach", *Proc. of FG 2008 - 8th IEEE International Conference on Automatic Face and Gesture Recognition*, Amsterdam, The Netherlands, September 2008.
- [171] **ISEM and IST Teams**, "Underwater vehicle technology in the VENUS project", *Proc. of UUVS 2008 – 12th Unmanned Underwater Vehicle Showcase*, Southampton, UK, September 2008.

- [172] **M. Spaan, F. Oliehoek, N. Vlassis**, “Multiagent Planning under Uncertainty with Stochastic Communication Delays”, *Proc. of ICAPS 2008 - 18th International Conference on Automated Planning and Scheduling*, Sydney, Australia, September 2008.
- [173] **F. S. Melo and M. Lopes**, “Fitted natural actor-critic: A new algorithm for continuous state-action MDPs”, *Proc. of ECML/PKDD 2008 - European Conference on Machine Learning*, Antwerp, Belgium, September 2008.
- [174] **G. Saponaro, A. Bernardino**, “Pose Estimation for Grasping Preparation from Stereo Ellipses”, *Proc. of CLAWAR 2008 Workshop on Humanoid Robotics*, Coimbra, Portugal, September 2008.
- [175] **J. Sequeira**, “Architectural Aspects of Networked Robotic Systems”, *Proc. of SSRR 2008 - IEEE International Workshop on Safety, Security, and Rescue Robotics*, Sendai, Japan, October 2008.
- [176] **T. Araújo and R. Dinis**, “Analytical Evaluation of Nonlinear Distortion Effects on OFDMA Signals used in the Downlink Transmission”, *Proc. of ISWCS 2008 – IEEE International Symposium on Wireless Communication System*, Reykjavik, Iceland, October 2008.
- [177] **P. Pedrosa, R. Dinis, F. Nunes**, “Performance Evaluation of Decision-Directed Carrier Synchronization for SC-FDE Schemes”, *Proc. of ISWCS 2008 – IEEE International Symposium on Wireless Communication System*, Reykjavik, Iceland, October 2008.
- [178] **P. Carvalho, J. Martins, L. Bernardo, R. Dinis**, “Effective Power Control in UWB Systems Using Spreading Code’s Spatial Resolution Properties”, *Proc. of ISWCS 2008 – IEEE International Symposium on Wireless Communication System*, Reykjavik, Iceland, October 2008.
- [179] **E. Grossmann, J. Gaspar and F. Orabona**, “Calibration from statistical properties of the visual world”, *Proc. of ECCV 2008 - European Conference on Computer Vision*, Marseille, France, October 2008.
- [180] **M. Silveira, S. Heleno**, “Water/Land Segmentation in SAR Images using Level Sets”, *Proc. of ICIP 2008 - IEEE International Conference on Image Processing*, San Diego, California, USA, October 2008.
- [181] **M. Silveira, J. Nascimento, J. Marques**, “Level Set Segmentation with Outlier Rejection”, *Proc. of ICIP 2008 - IEEE International Conference on Image Processing*, San Diego, California, USA, October 2008.
- [182] **J. Nascimento, M. Figueiredo, J. S. Marques**, “Learning of Motion patterns using Generative Models”, *Proc. of ICIP 2008 - IEEE International Conference on Image Processing*, San Diego, California, USA, October 2008.
- [183] **J. Nascimento, J. Sanches**, “Ultrasound Imaging LV tracking with adaptive window size and automatic hyper-parameter estimation”, *Proc. of ICIP 2008 - IEEE International Conference on Image Processing*, pp. 553-556, San Diego, California, USA, October 2008.
- [184] **I. Rodrigues, J. Sanches and J. Bioucas-Dias**, “Denoising of Medical Images Corrupted by Poisson Noise”, *Proc. of ICIP 2008 - IEEE International Conference on Image Processing*, San Diego, California, USA, October 2008.

- [185] **L. Caldeira, I. Silva and J. Sanches**, "Automatic Liver Tumor Diagnosis with Dynamic-contrast Enhanced MRI", *Proc. of ICIP 2008 - IEEE International Conference on Image Processing*, San Diego, California, USA, October 2008.
- [186] **D. Afonso, J. Sanches and M. H. Lauterbach**, "Robust Brain Activation Detection in Functional MRI", *Proc. of ICIP 2008 - IEEE International Conference on Image Processing*, San Diego, California, USA, October 2008.
- [187] **B. Pires, J. M. F. Moura, J. Xavier**, "LASIC: a model invariant framework for correspondence", *Proc. of ICIP 2008 - IEEE International Conference on Image Processing*, San Diego, California, USA, October 2008.
- [188] **J. J. Rodrigues, J. Xavier, and P. Aguiar**, "Classification of unlabeled point sets using ANSIG", *Proc. of ICIP 2008 - IEEE International Conference on Image Processing*, San Diego, California, USA, October 2008.
- [189] **P. Aguiar, J. Xavier, and M. Stosic**, "Globally optimal solution to exploit rigidity when recovering structure from motion under occlusion", *Proc. of ICIP 2008 - IEEE International Conference on Image Processing*, San Diego, California, USA, October 2008.
- [190] **N. Fachada, V. V. Lopes, A. C. Rosa**, "Simulation of immune system response to bacterial challenge", *Proc. of ESM 2008 - European Simulation and Modeling*, Le Havre, France, pp 252-257, October 2008.
- [191] **P.A. Castillo, J. Laredo, A. Mora, C. Fernandes, J. Merelo**, "Addressing Churn in a Peer-to-Peer Evolutionary Algorithm", *Proc. of WPABA 2008 - 1st International Workshop on Parallel Architecture and Bioinspired Algorithms*, Toronto, Canada, pp. 5-12, October 2008. ISBN 978-84-691-6513-3.
- [192] **M. Taiana, J. Santos, J. Gaspar, J. Nascimento, A. Bernardino, and P. Lima**, "Color 3D model-based tracking with arbitrary projection models", *Workshop on Omnidirectional Robot Vision, (OmniRoboVis2008) in conjunction with International Conference on Simulation, Modeling, and Programming for Autonomous Robots (SIMPAN 2008)*, Venice, Italy, November 2008.
- [193] **M. Taiana, J. Santos, J. Gaspar, J. Nascimento, A. Bernardino, P. Lima**, "Color 3D Model-Based Tracking with Arbitrary Projection Models", *Proc. of SIMPAR 2008 - International Conference on Simulation, Modeling and Programming for Autonomous Robots, Workshop on Omnidirectional Robot Vision*, Venice, Italy, November 2008.
- [194] **M. Taiana, J. Santos, J. Gaspar, J. Nascimento, A. Bernardino, P. Lima**, "Color 3D Model-Based Tracking with Arbitrary Projection Models", *Proc. of SIMPAR 2008 - International Conference on Simulation, Modeling and Programming for Autonomous Robots, Workshop on Omnidirectional Robot Vision*, Venice, Italy, November 2008.
- [195] **R. Ventura**, "Action and Adaptation: Lessons from Neurobiology and Challenges for Robot Cognitive Architectures", *Proc. of AAAI Fall Symposium: Biologically Inspired Cognitive Architectures*, Washington DC, USA, November 2008.

- [196] **N. Delgado, F. Nunes and J. Xavier**, "GNSS satellite selection for multiple-constellations using convex geometry", *Proc. of 4th ESA Workshop on Satellite Navigation User Equipment Technologies*, December 2008.
- [197] **D. Antunes, J. Hespanha, C. Silvestre, N. Kataria, F. Brewer**, "Computationally Efficient Methods for Digital Control", *Proc. CDC 2008 - 47th IEEE Conference on Decision and Control*, Cancun, Mexico, December 2008.
- [198] **P. Batista, C. Silvestre, P. Oliveira**, "Optimal Position and Velocity Navigation Filters with Discrete-Time Delayed Measurements", *Proc. of CDC 2008 - 47th IEEE Conference on Decision and Control*, Cancun, Mexico, December 2008.
- [199] **A. Peñas, P. Oliveira, A. Pascoal, R. Cunha, C. Silvestre**, "A Dynamic Estimator on SE(3) Using Range-Only Measurements", *Proc. of CDC 2008 - 47th IEEE Conference on Decision and Control*, Cancun, Mexico, December 2008.
- [200] **J. Vasconcelos, C. Silvestre, P. Oliveira**, "A Nonlinear GPS/IMU Based Observer for Rigid Body Attitude and Position Estimation", *Proc. CDC 2008 - 47th IEEE Conference on Decision and Control*, Cancun, Mexico, December 2008.

h) In National Journals (1)

- [201] **J. Seabra, L.M. Pedro, J. Sanches, F. Viola, A.C. Dinis, J. Mendanha, P. Brogueira and M.T. Peña**, "Investigação no Ensino de Engenharia Biomédica: dois casos de estudo", *Saúde & Tecnologia*, pp. 7-19, May 2008.

i) In National Conferences (20)

- [202] **J. Messias, J. Santos, J. Antunes, P. Lima**, "Monte Carlo Localization Based on Gyrodometry and Line-Detection", *Proc. of ROBÓTICA 2008 - 8th Conference on Mobile Robots and Competitions*, Aveiro, Portugal, April 2008.
- [203] **M. Neves, J. Marques, A. Bernardino, J. Santos-Victor**, "Experiments on Vision Based Control of and Indoors RF Blimp", *Proc. of Controlo 2008 - 8th Portuguese Conference on Automatic Control*, Vila Real, Portugal, July 2008.
- [204] **P. Carreiras, A. Bernardino, J. Santos-Victor**, "Predictive Reaching control with Multiple motion Models", *Proc. of Controlo 2008 - 8th Portuguese Conference on Automatic Control*, Vila Real, Portugal, July 2008.
- [205] **M. S. C. Almeida, J. Sanches, L. B. Almeida**, "Blind Adaptative Deblurring of Chromosome images", *Proc. of FPBC 2008 - First Portuguese Forum on Computational Biology*, Gulbenkian Institute of Science, Oeiras, Portugal, July 2008.
- [206] **A. Khmelinskii, R. Ventura, M. Carmo-Fonseca, J. Sanches**, "Automatic Pairing of Metaphase Chromosomes with Mutual Information for Karyotyping Purposes", (Poster), *Proc. of FPBC-2008 -*

First Portuguese Forum on Computational Biology, Gulbenkian Institute of Science, Oeiras, Portugal, July 2008.

- [207] **I. Rodrigues, J. Sanches**, “Spatio-temporal 3D reconstruction from fluorescent microscopy images with anisotropic filtering”, (Poster), *Proc. of FPBC-2008 - First Portuguese Forum on Computational Biology*, Gulbenkian Institute of Science, Oeiras, Portugal, July 2008.
- [208] **I. Rodrigues, J. Sanches**, “Cell nucleus GFP flow analysis from sequences of LSCFM images” (Poster), *Proc. of Portugal-UT Austin CFD 2008 - 1st Workshop on Computational Engineering: Fluid Dynamics*, IST, Lisbon, Portugal, July 2008.
- [209] **J. Santos, J. Sanches, S. Carvalho**, “Autonomic Nervous System Control Model of the Blood Pressure and Heart Rate Physiological Variables” (Poster), *Proc. of Portugal-UT Austin CFD 2008 - 1st Workshop on Computational Engineering: Fluid Dynamics*, IST, Lisbon, Portugal, July 2008.
- [210] **J. Santos, J. Sanches, S. Carvalho**, “Autonomic Nervous System Control Model of the Blood Pressure and Heart Rate Physiological Variables”, *Workshop Physics of Biological Systems: From Genes to Societies*, Lisbon, Portugal, October 2008.
- [211] **P. Pires, J. Sanches, T. Paiva**, “Activity Characterization from Actimetry Sensor Data for Sleep Disorders Diagnosis”, *Workshop Physics of Biological Systems: From Genes to Societies*, Lisbon, Portugal, October 2008.
- [212] **J. A. Martins, J. Rodrigues, J.M.H.du Buf**, “Region segregation and saliency using colour information”, *Proc. of RecPad 2008 - 14th Portuguese Conference on Pattern Recognition*, Coimbra, Portugal, October 2008.
- [213] **I. Silva, J. Sanches, A. Almeida**, “Alignment-by-Reconstruction in Cardiac MRI”, *Proc. of RecPad 2008 - 14th Portuguese Conference on Pattern Recognition*, Coimbra, Portugal, October 2008.
- [214] **I. Rodrigues, J. Sanches**, “Fluorescence Confocal Imaging Noise Removal: A Bayesian Approach”, *Proc. of RecPad 2008 - 14th Portuguese Conference on Pattern Recognition*, Coimbra, Portugal, October 2008.
- [215] **J. Santos, J. Sanches, S. Carvalho**, “Autonomic Nervous System Control Model of the Blood Pressure and Heart Rate Physiological Variables”, *Proc. of RecPad 2008 - 14th Portuguese Conference on Pattern Recognition*, Coimbra, Portugal, October 2008.
- [216] **J. Coelho, J. Sanches, M. Lauterbach**, “fMRI Binary Detection”, *Proc. of RecPad 2008 - 14th Portuguese Conference on Pattern Recognition*, Coimbra, Portugal, October 2008.
- [217] **R. Ribeiro, J. Seabra, J. Sanches**, “Fatty Liver Automatic Diagnosis from Ultrasound Images”, *Proc. of RecPad 2008 - 14th Portuguese Conference on Pattern Recognition*, Coimbra, Portugal, October 2008.
- [218] **J. Seabra, J. Sanches**, “Labeling of the Echo-Morphology of Atherosclerotic Plaques using Graph-Cuts”, *Proc. of RecPad 2008 - 14th Portuguese Conference on Pattern Recognition*, Coimbra, Portugal, October 2008.

- [219] **N. Leite, A. Del Bue, J. Gaspar**, "Calibrating a Network of Cameras Based on Visual Odometry", *Proc. of JETC 2008 - IV Jornadas de Engenharia Electrónica e Telecomunicações e de Computadores*, Lisbon, Portugal, pp. 174-179, November 2008.
- [220] **R. Carona, A. Aguiar, J. Gaspar**, "Control of Unicycle Type Robots: Tracking, Path Following and Point Stabilization", *Proc. of JETC 2008 - IV Jornadas de Engenharia Electrónica e Telecomunicações e de Computadores*, Lisbon, Portugal, pp. 180-185, November 2008.
- [221] **B. Dias, R. Ventura, J. Gaspar**, "Automatic Transcription of Musical-Whistling: Comparing Pitch Detection Methods", *Proc. of JETC 2008 - IV Jornadas de Engenharia Electrónica e Telecomunicações e de Computadores*, Lisbon, Portugal, November 2008.

j) In Technical Reports (3)

- [222] **P. J Santos**, "Makai Ex 2005: the Vector Sensor Array (VSA) data", Rep. 03/08, SiPLAB Report, University of Algarve, October 2008.
- [223] **P. J. Santos**, "Vector Sensor Array (VSA) simulations", Rep. 02/08, SiPLAB Report, University of Algarve, October 2008.
- [224] **C. Lima, C. Fernandes, F. Lobo**, Investigating Restricted Tournament Replacement in ECGA for Non-Stationary Environments (extended version), IlliGAL Technical Report No. 2008010, University of Illinois at Urbana-Champaign, 2008.

3 LABORATORY FACILITIES AND SERVICES

3.1 Common Facilities

ISR/IST has a computer network infra-structure based on 5 PC servers, providing basic services such as mail and web servers, shell accounts, firewall, among others (databases, mailing lists, SVN, FTP, backup, etc.). These servers are located on a data center room with dedicated AVAC. The firewall provides IP connectivity (both IPv4 and IPv6) to the IST campus network. About 220 users have accounts on the isr.ist.utl.pt domain mail and/or shell, and more than 300 machines, including PCs, SUN workstations, Macintoshes and others, are currently linked to the network, using switching technology (Ethernet 10/100/1000). Moreover, all ISR facilities are covered by the campus WiFi 802.11b/g network, thus providing wireless access to the Internet to all ISR users.

3.2 Laboratory Facilities

INTELLIGENT SYSTEMS Lab (IS)

The ISLab offers the main following facilities:

- 1 all-terrain remotely-operated (by wireless or cable LAN) robot (RAPOSA), endowed with several sensors for detection of dangerous gases, humidity, and temperature, a thermal camera, several web cams (some of them with controllable pan);
- 5 omni-directional (3 wheels) robots endowed with an on-board laptop with wireless communications, rate-gyro, 16 sonars, omni-directional catadioptric system, optical mouse for odometry, electromechanical kicker and rolling drum systems for robotic soccer applications;
- 1 RWI ATRV-Jr mobile robot, 4-wheel drive, equipped with 16 sonars, GPS, inertial navigation module and a compass, pan and tilt vision system and one SICK Laser scanner (shared with the Mobile Robotics and Computer and Robot Vision Labs);
- 1 Blimp aerial robot, with pan and tilt vision system, 3 servomotors, RF link for remote control and remote video-link for video transmission (shared with the Mobile Robotics and Computer and Robot Vision Labs);
- 4 Nomadic Super-Scout II mobile robots, with updated electronics (by IdMind) equipped with 16 sonars and 2 cameras each, one of them part of an omni-directional catadioptric system;
- 14 Philips 740K USB Web Cams, used in the Super-Scout II robots;
- 1 Real-Time RF video link;
- 1 Space Mouse device, for teleoperation of mobile robots and manipulators;
- 35 Pentium Personal Computers (PIII or PIV, including 10 laptops, 4 of them for the omni-directional robots) – under Linux and Windows 2000/XP OS;
- 1 Small humanoid robot (Robotis Bioloid kit);
- 1 Small laser range finder (Hokuyo);
- 3 Novatel RTK GPS systems with external antennas;
- 2 Raytheon infrared cameras (one of them installed in the RAPOSA robot);
- 3 wireless Access points (one of which is a high-performance a/b/g/n Cisco with MIMO technology for diversity);
- Matlab and Simulink software for different simulation projects;
- 1 PRO and 1 Student Webots simulator licenses (shared with the Mobile Robotics and Computer and Robot Vision Labs);

MOBILE ROBOTICS Lab (LRM)

The LRM offers the main following facilities:

- 2 Scout mobile platforms with on-board computer, one of them with a video camera, and wireless Ethernet;
- 1 ATRV Jr Rover with ultrasound sensors, GPS and Inertial Measurement Unit. This mobile platform is shared with the Intelligent Systems and Computer Vision Laboratories;
- 4 Sony dogs Aibo, shared with the Intelligent Systems Lab;
- A complete set of the LEGO Mindstorms system for Mobile Robotics;
- A Laser Range Finder from the Riegl supplier with range and luminance measurement;
- 3 Sick Laser Scanners;
- Three computer controlled Pan & Tilt Units from Direct Perception;
- Video cameras, including two Quick Cams and a Network Eye supporting direct display of real scenes on the Internet;
- 10 Pentium PCs + 5 portable Pentiums;
- Three laser printers, and one DeskJet colour printer;
- 1 PC with VME bus;
- 8 webcams;
- 2 ethernet switches 100Mbps;
- 1 ethernet access point;
- 5 USB wireless adapters;
- 2 pairs of ethernet modems from OTC;
- 1 oscilloscope (digital) Tektronix.

A large open space appropriate for mobile robotics navigation experiments.

COMPUTER VISION Lab (VISLAB)

The VisLab is equipped with various PCs, various cameras (CCD, CMOS, Colour, Black & White, Digital or Analogue) and image frame grabbers, a pan-tilt unit and several pan-tilt cameras.

Special equipment consists of:

- Baltazar Humanoid Torso: composed of a high-speed 4 degrees of freedom binocular head, an articulated arm and hand, for research in learning by imitation (see pictures below).
- Vizzy – another humanoid platform that is mounted on a segway mobile base. Construction is planned to be finished in 2009.
- Two robotic heads designed for the iCub, each with 6 degrees of freedom, an inertial sensor, audio and ability to perform facial expressions (see pictures below).
- TRC LabMate mobile platform.
- One Pioneer mobile platform equipped with a manipulator.
- Two Nomad Superscout mobile platforms, equipped with vision and an on-board computer.
- One Tobii system for gaze tracking
- One data glove and magnetic tracker

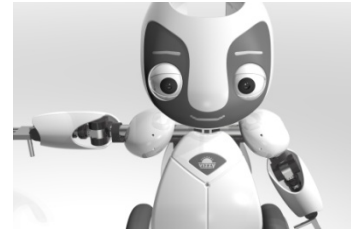
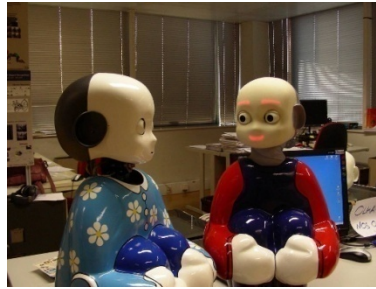

SIGNAL AND IMAGE PROCESSING GROUP (SIPG) – LISBON

The SIPG at IST offers the main following facilities:

- Intel-compatible personal computers;
- Xerox Phaser 8550 Color printer;
- 100 Mbit/s thin Ethernet LAN interfacing the Signal Processing Laboratory to the ISR Network;
- ORCA underwater acoustic communication system (surface modem with programmable acoustic receiver, underwater modem);
- Texas Instruments TMS320C6711 hardware (software DSP development system);
- Motorola software development system for the DSP56000 digital signal processor (DSP);
- 2 Xilinx field programmable gate array (FPGA) hardware/software development systems;
- 2 Signalware high-speed multichannel analog I/O boards for the TMS320C6711 DSP starter kit;
- National Instruments multifunction data acquisition boards (1 MIO-16E-4 PCI board, 2 PC-Cards) and LabView virtual instrumentation software;
- 1 National Instruments digital I/O PCI board;
- 1 TEAC CS-391 multichannel data recorder;
- 1 Goldstar OS-9040D 40 MHz analog oscilloscope;
- 1 Hewlett-Packard HP8116A 50 MHz function generator
- 1 Escort EGC 3230 2 MHz function generator with 100 MHz frequency meter;
- 1 Sony F670ES power amplifier;
- 1 Kiotto KT-1990EX digital multimeter;
- 1 GW ST3030TD triple power supply;
- 1 Weller WTCP-S soldering station.

SIGNAL AND IMAGE PROCESSING GROUP (SIPG) – ALGARVE

The SIPG at UALG offers the main following facilities:

- room with research desks divided in cubicles + computer servers (mostly Linux) + printer set (B&W and color), backup and storage systems;
- software resources: Matlab, C and Fortran compilers;
- book literature (computational methods, C and Fortran programming, signal processing, etc.);
- Acoustic Oceanographic Buoy – version 2 (AOB2);
- Acoustic Oceanographic Buoy – version 1 (AOB1);
- Broadband Lubell acoustic source;
- Low frequency acoustic source;

- Ultra Light Vertical Array (ULVA);

DYNAMICAL SYSTEMS AND OCEAN ROBOTICS Lab (DSOR)

Mechanical / Electric shop (8th Floor of ISR) - basic equipment and tools to machine mechanical pieces and to assemble circuit boards.

Very High Precision Calibration Table (for motion sensor testing and calibration)

Small **Zodiac** to support operations at sea.

DELFIN and DELFIN_X Autonomous Surface Vehicles (ASCs) – designed and built by ISR/IST to carry out experimental research in the area of ocean robotics and to perform scientific missions at sea. DELFIN Length: 3.5m, Width: 2m, Weight: 320 Kg. DELFINx Length: 4.5 m, Width: 2.4 m, Weight: 300 Kg. Propulsion by electric motors. These vehicles have been used to acquire marine Data in the Azores, in cooperation with the partner IMAR/DOP and to carry out experiments on single and multiple vehicle cooperative control.

INFANTE Autonomous Underwater Vehicle (AUV) – designed and built by ISR/IST and the company RINAVE to carry out experimental research in the area of ocean robotics and to perform scientific missions at sea. The vehicle is 4:5m long, 1:1m wide and 0:6m high. It is equipped with two main thrusters (propellers and nozzles) for cruising and fully moving surfaces (rudders, bow planes and stern planes) for vehicle steering and diving in the horizontal and vertical planes, respectively.

MAYA AUV – designed and built by a Luso-Indian consortium consisting of NIO (Goa, India), ISR/IST, IMAR/DOP/UAzores, and RINAVE. A small, modular, autonomous underwater vehicle (AUV) for scientific and commercial applications. Missions include geological and oceanographic surveys, marine habitat mapping, inspection of harbours and estuaries. The first prototype has been tested and used extensively in Goa, India.

CARAVELA 2000 Autonomous Research Vessel – designed and built by IMAR/DOP/UAzores, ISR/IST, and the companies RINAVE. And CONAFI Prototype of an autonomous surface craft for long range missions at sea (co-owned by IST/ISR, IMAR/Dept. Oceanography and Fisheries of the Univ. Azores, RINAVE, and CONAFI).

Autonomous Helicopter (Bergen Industrial Twin) - a small-scale industrial helicopter. This is a transformed radio-controlled helicopter, about 1.6m long (including the rotor diameter), with a payload capability of 10 kg, and a top speed of 70 Km per hour.

IRIS TOOL – designed and built by ISR/IST. A high accuracy surveying tool for both the above water and submerged parts of semi submerged structures. IRIS is equipped with an accurate Laser Scanner, a profiler sonar, a high end motion reference unit, and a surveying class GPS.

Medusa I – designed and built by ISR/IST. First prototype of a class of semi-submerged vehicles of small size for underwater target positioning. A set of vehicles acting cooperatively will be used in the scope of the EU COGAUVs (Cognitive marine robotics) project for assisted diving operations.

Mechanical/ Electrical Equipment

- **Pressure Chamber** - to test the marinization of equipment down to depths of 600 meters.

- **Crane** with the capacity to handle loads of up to 2500 Kg.
- **Industrial air compressor.**
- **2 Trailers for the transportation of marine vehicles.**

Actuators and Sensors for Robotic Ocean Vehicle Development and Operation (part of the equipment is dedicated to the operation of the autonomous marine vehicles that are property of IST/ISR).

- *Actuators* - 5 electrical thrusters.
- 3 rate gyros, 2 pendulums and 1 fluxgate (Watson's Attitude & Heading Reference Unit AHRS-C303);
- 3 rate gyros, 3 accelerometers and 1 magnetometer (SEATEX MRU-6)
- 3 rate gyros, 2 pendulums and 1 magnetometer (KVH attitude reference unit).
- 1 flowmeter TSA-06-C-A (EG & G Flow Technology);
- 2 depth cells DC 10R-C (Transinstruments);
- 2 echosounders ST200 (Tritech);
- 2 echosounders ST500 (Tritech);
- 1 Sidescan sonar (System Technologies / Tritech);
- 1 Acoustic Modem for underwater communications (System Technologies / Tritech);
- GIB (GPS Intelligent Buoys) – GPS based underwater positioning system, with target tracking capabilities.
- 1 Doppler Log TSM 5740 with 4 beams in a Janus configuration, operating at 300 KHz (Thomson-ASM);
- 1 Doppler Log, operating at 600 KHz, rated for 2000 m (RDI);
- 1 set of 3 rate gyros, 2 pendulums and 1 directional gyro from Humphreys.
- 1 *Long Baseline Positioning System* for underwater vehicle positioning - 1 transducer and 4 transponders.
- 1 *DGPS (Differential Global Positioning System)* for accurate surface vehicle navigation - 4 Motorola Encore unit and 3 FREEWAVE radios.
- 1 Multibeam unit (RESON)
- 1 Integrated Sidescan/Subbottom profiler unit
- 4 sets of Acoustic Modems

Software Tools for Navigation, Guidance, and Control System Design.

NetMarSys (Networked Marine Systems Simulator), with Hardware-in-the-loop capabilities. Modeling and simulation tool for *the integrated analysis and design of navigation, guidance and control systems for multiple autonomous marine vehicles*. The software was developed at IST/ISR and is built around the commercially available package MATLAB. It provides the means to assess the combined performance of navigation, guidance, and single and multiple vehicle control systems prior to their implementation.

General Computer Facilities.

- 12 Desktop PCs
- 8 Laptop PCs
- 2 Laser printers

EVOLUTIONARY SYSTEMS AND BIOMEDICAL ENGINEERING Lab (LASEEB)

The Laseeb offers the main following facilities on digital signal processing for biomedical engineering, digitalization and development for multimedia applications:

- 20 Personal Computers running Windows 98/NT4/2000 and Linux;
- 2 Laser printer;
- 2 color inkjet printers;
- 1 Video Capture Board MIRO VIDEO DC30;
- 3 Cd-RW Recorders;
- 1 Tape Backup 12 Gb;
- 1 Scanner;
- 1 Biological amplifier Medelec;
- 1 Biological amplifier Braintronics;
- 1 Biological amplifier CAPS;
- 2x30 ch. A/D Acquisition DT 2834 16 Hz;
- 2x16 ch. A/D Acquisition DT 2821 150 Hz;
- 1x16 ch. A/D Acquisition DT 2811 30 Khz;
- 1x8 ch A/D Acquisition PCMCIA 50Khz.

In the Laseeb Sleep Laboratory:

- Sonolab 632 from MEditron – Polysomnography Acquisition System;
- 1 Infrared Video Monitoring system from Meditron – sleep video;
- 1 LED bright light phototherapy from Meditron – Phase delay and advance therapy device;
- Med Supply A8000 from Meditron – CPAP machine;
- 1 Sonolab X1 from Meditron – Digital Pulse Oximetry;

Added 4 Quad Core with GTX 9200 GPU