



INSTITUTE FOR SYSTEMS AND ROBOTICS

Annual Report – 2003



Lisbon Pole



*Torre Norte, Piso 7
IST, Av. Rovisco Pais
1049 - 001 Lisboa
Portugal*

Director

Prof. João José dos Santos Sentieiro

Vice - Director

Prof. Maria Isabel Lobato de Faria Ribeiro

Torre Norte, 7º Piso

IST, Av. Rovisco Pais

1049 - 001 Lisboa

Portugal

Tel.: + 351 21 841 82 89

Fax.: + 351 21 841 82 91

e-mail: jjss@isr.ist.utl.pt

Table of Contents

OVERVIEW	1
1. ISR IN NUMBERS	3
2. RESEARCH TEAM AND INTERESTS	4
2.1 Members and Collaborators	4
2.2 Current Research Interests	6
2.2.1 <i>Intelligent Systems</i>	6
2.2.2 <i>Computer and Robot Vision</i>	8
2.2.3 <i>Mobile Robotics</i>	10
2.2.4 <i>Signal and Image Processing</i>	11
2.2.5 <i>Evolutionary Systems and Biomedical Engineering</i>	12
2.2.6 <i>Dynamical Systems and Ocean Robotics</i>	14
2.2.7 <i>Aeronautics</i>	24
3. RESEARCH ACTIVITIES	25
3.1 Research Projects	25
3.1.1 <i>Underwater and Ocean Robotics</i>	25
3.1.2 <i>Cooperative Robotics</i>	32
3.1.3 <i>Educational Robotics</i>	34
3.1.4 <i>Image Processing</i>	35
3.1.5 <i>Underwater Acoustics</i>	38
3.1.6 <i>Computer Vision</i>	40
3.1.7 <i>Artificial Intelligence</i>	42
3.1.8 <i>Communications</i>	43
3.1.9 <i>Aeronautics</i>	46
3.1.10 <i>Unmanned Air Vehicles</i>	48
3.1.11 <i>Non-Linear Control</i>	49

3.2	Post-Docs Activities Report	51
3.2.1	<i>Activity Report of Sebastian Bausson</i>	51
3.2.2	<i>Activity Report of Pierre Borgnat</i>	52
3.2.3	<i>Activity Report of Etienne Grossmann</i>	53
3.2.4	<i>Activity Report of Nuno Gracias</i>	53
3.2.5	<i>Activity Report of Ettore Barros</i>	54
3.3	Theses	56
3.3.1	<i>Theses Concluded During 2003</i>	57
3.3.2	<i>Theses in Progress During 2003</i>	66
3.4	Advanced Training	80
3.4.1	<i>Courses</i>	80
3.4.2	<i>Seminars</i>	81
3.4.3	<i>Reading Groups</i>	84
3.4.4	<i>Visits Abroad</i>	84
3.4.5	<i>Supervision of Students Enrolled in Foreign Universities</i>	84
3.5	Congress, Meetings and Presentations	85
3.5.1	<i>Invited Talks</i>	85
3.5.2	<i>Promotion of Science and Technology Among the Youth</i>	86
3.5.3	<i>Participations</i>	86
3.6	Service Activities	88
3.6.1	<i>Editorial Boards</i>	88
3.6.2	<i>Advisory Boards</i>	88
3.6.3	<i>Programme and Technical Committees</i>	88
3.6.4	<i>Chairperson</i>	91
3.6.5	<i>Reviewers</i>	91
3.6.6	<i>Other Activities</i>	94
3.7	Academic Activities	96
3.8	Distinguished Visitors	99
3.9	Special Events	100
3.9.1	<i>ROBÓTICA 2003 – 3rd Portuguese Robotics Open (Festival Nacional de Robótica)</i>	100
3.9.2	<i>Construção de um Robot Futebolista</i>	100

3.9.3	<i>1st ISLAB WorkShop</i>	101
3.9.4	<i>2nd ISLAB WorkShop</i>	101
3.9.5	<i>Maritime Rapid Environmental Assessment '03 Sea Trial</i>	101
3.9.6	<i>Infante Sea Trial</i>	102
3.9.7	<i>Participation in the Exhibit "Engenho e Obra"</i>	102
3.10	Awards	104
3.11	Publications	105
4.	LABORATORY FACILITIES AND SERVICES	114
4.1	Common Facilities	114
4.1	Laboratory Facilities	114

OVERVIEW

Since its foundation, ISR (Lisbon) has given special attention to international cooperation in order to strengthen and broaden its scientific competence. Two types of cooperation are especially noteworthy: firstly, participation in R&D projects in conjunction with universities, research centers, and European businesses of note under the auspices of programs funded by the Portuguese Science and Technology Foundation, European Community and other agencies; and, secondly, training initiatives, primarily through master and doctoral programs. These initiatives have involved not only the Instituto Superior Técnico (IST) and the University of Algarve (UA) but also universities and research centers in Europe and the United States.

In 2003¹ we have continued our efforts in order to push theoretical developments in the fields of Marine Robotics, Underwater Acoustics, Mobile Communications, Computer Vision, Cooperative Robotics and Formation Estimation and Control promoting international cooperation through joint projects; trying to reinforce the teams with full time and post-doc researchers; bridging the gap between theory and practice by pushing the collaboration with marine scientists, environmental experts and government agencies interested in the management of ocean resources and civil protection; trying to endow researchers with the infra-structures and technical personnel required for the development and testing of ocean equipment and vehicles.

Also special attention was given by ISR (Lisbon) to the active promotion of scientific culture and public understanding of science, both within Portugal and Worldwide. Within this context ISR-Lisbon has, with the support of FCT and "Ciência Viva", participated in a number of initiatives aiming to increase the levels of public understanding, awareness of, and involvement in, issues concerning science and technology.

In 2003 ISR has offered several courses in the Doctoral and Master Programs in Electrical and Computer Engineering of IST, as well as other post-graduate level courses. Also seminars were organized in a regular basis. The courses and seminars were attended by a large number of Ph.D. students and faculty.

In 2003, 132 senior and junior researchers have developed their research activities within ISR (Lisbon Pole). These included 29 professors, 1 Principal Researcher, 8 post-docs, 44 Ph.D. Students, 24 M.Sc. Students and 26 undergraduate research trainees.

During 2003, the institute researchers have been involved in a large number of national and international R&D projects, financial resources being provided at a national (FCT, ICCTI, AdI, Ciência Viva, private companies) and international level (EU, ESA and others), contributing to increase the international visibility of the institution. As a result of these activities 6 M.Sc. and 6 Ph.D. theses were concluded, 3 papers were published in books, 26 papers were published in well known international journals, and 58 papers presented at prestigious international conferences. Steps keep being taken to encourage researchers to increase the publication of their research results in archive journals. Also the number of publications by Post-Docs is, in general, beyond expected and hence efforts should be made by their supervisors in order to change the situation.

The training of young researchers has pursued, involving 44 Ph.D. Students (Portuguese and foreigners) and 24 M. Sc. Students (Portuguese). Six researchers have concluded their doctoral theses, and 6 researchers have concluded their M. Sc. theses. Also, young licentiates from several European countries have come to participate in short and medium term research initiatives.

Several ISR researchers have stayed short or long periods abroad, as visiting or invited professors, researchers or students. Several foreign senior and junior researchers have visited and stayed with ISR.

The participation in editorial boards of international journals, and in the program committees of international conferences of high reputation was also very active.

¹ In 2003, the Associate Laboratory ISR-Lisbon in partnership with the other 3 founding units (o Centro de Estudos em Inovação, Tecnologia e Políticas de Desenvolvimento do Instituto Superior Técnico - IN+, o Centro de Recursos Minerais, Mineralogia e Cristalografia - CREMINER, da Universidade de Lisboa e o Centro do IMAR da Universidade dos Açores) has been involved in a large number of activities that will be described in a different report.

ISR has organized the 3rd Portuguese Robotics Open (ROBOTICA2003 - Festival Nacional de Robótica). The Workshops "Building a Junior Football Player for Robótica 2003" was also organized aiming at motivating high school students for Science and Technology. Full scale models of the autonomous underwater and autonomous surface vehicles developed at ISR were on display in the Exhibit "Engenho e Obra". Initiatives involving ISR researchers and high school students have been organized as well.

As closing remarks I would like to stress the fact that despite the financial difficulties (the usual FCT "plurianual" financing is now delayed for more than two years, the same happening with the financing of a large number of projects), the international visibility of ISR and in particular of some of his groups has increased significantly. This fact translates not only on the increasing number of foreign graduate students and post-docs wishing to pursue their research careers at ISR, but also on the international contacts leading to collaboration projects and in the interest that Workshops and Conferences organized by ISR are raising in the scientific community.

Due to the absence of a clear commitment from FCT that funding will be available in a regular basis, and the shortage of funds received in 2003, we have not been able to initiate the process of contracting new researchers, both post-docs and PhD students. It is my belief that if FCT does not urgently fulfill the agreement signed with ISR in 2001, concerning the plurianual financing and the hiring of 14 new post-doc researchers and 4 technical staff, it will be no longer possible to maintain the degree of excellency that has been recognized to our institution by the independent international evaluation panels. Also, if the "re-equipment program" launched by the FCT in 2001 and presently frozen is not resumed, top institutions like ours will have to review their strategic objectives, with natural negative consequences for the progress of science and technology in Portugal.

As in previous years, we urge again the host institution, IST, to recognize the research and graduate advising contributions of the faculty through the assignment of different classroom teaching loads and through the increase of administrative and technical support for all our laboratories.

João Sentieiro
ISR, April 19, 2004

1. ISR IN NUMBERS

(2003)

Research Team:

University Professors:	29
Principal Researchers:	01
Post-Docs:	08
Ph.D. Students:	44
M.Sc. Students:	24
Undergraduate Students:	26

Total: 132

Research Projects: 41

Doctoral theses concluded: 06

Master theses concluded: 06

Publications:

Books:	00
In Books:	03
In International Journals:	26
In National Journals:	01
In International Conferences:	58
In National Conferences:	14
Technical Reports:	28

(2002)

Research Team:

University Professors:	27
Principal Researchers:	01
Post-Docs:	07
Ph.D. Students:	44
M.Sc. Students:	26
Undergraduate Students:	39

Total: 144

Research Projects: 39

Doctoral theses concluded: 10

Master theses concluded: 05

Publications:

Books:	02
In Books:	12
In International Journals:	29
In National Journals:	01
In International Conferences:	74
In National Conferences:	09
Technical Reports:	21

2. RESEARCH TEAM AND INTERESTS

2.1 MEMBERS AND COLLABORATOR

THEORY GROUP:

Michael ATHANS, *Principal Researcher*
Luis Torres MAGALHÃES, *Full Professor IST*

INTELLIGENT SYSTEMS:

Carlos PINTO-FERREIRA, *Associate Professor (IST)*
Pedro LIMA, *Assistant Professor (IST)*
Luis M. CUSTÓDIO, *Assistant Professor (IST)*
Sónia MARQUES, *Adj. Professor (IPS), Ph.D. Student*
Rodrigo VENTURA, *Teaching Assistant (IST), Ph.D. Student*
Dejan MILUTINOVIC, *Ph.D. Student, FCT grantee*
Andrés GARCÍA, *Ph.D. Student, FCT grantee*
Miguel GARÇÃO, *Ph.D. Student*
Hugo COSTELHA, *PhD Student, FCT grantee*
Gonçalo NETO, *PhD Student, FCT grantee*
Pedro PINHEIRO, *MSc Student*
Miguel ARROZ, *MSc Student*
Vasco PIRES, *MSc Student*
Márcia MAÇÃS, *M.Sc. Student*
Bruno DAMAS, *M.Sc. Student*
Carla PENEDO, *M.Sc. Student*
João PAVÃO, *M.Sc. Student*
Pedro NUNES, *M.Sc. Student*
João FRAZÃO, *Research Assistant, AdI grantee*
Axel SCHNEIDER, *Student (Tech. Univ. of Chemnitz, Germany)*
Bob van der VECHT, *Student (Univ. of Gröningen, The Netherlands)*
Constança SOUSA, *Student*
Hugo VEIGA, *Student*

COMPUTER AND ROBOT VISION :

João SENTIEIRO, *Full Professor, ISR/IST Director*
José SANTOS-VICTOR, *Associate Professor*
João Paulo COSTEIRA, *Assistant Professor*
José António GASPAS, *Assistant Professor*
Alexandre BERNARDINO, *Teach. Assistant, Ph.D. St.*
Nuno GRACIAS, *Post-Doc*
Etienne GROSSMANN, *Post-Doc*
Plínio Moreno LOPEZ, *Ph.D. St.*
Manuel Cabido LOPES, *Ph.D. St.*
Ricardo OLIVEIRA, *Ph.D. St.*
Roger Alex de FREITAS, *visiting Ph.D. St.*
Raquel Frizzera VASSALLO, *visiting Ph.D. St.*
Sandra Esperanza Nope RODRIGUEZ, *visiting Ph.D. St.*
Pedro Canotilho RIBEIRO, *Researcher*

EVOLUTIONARY SYSTEMS AND BIOMEDICAL ENG. :

Agostinho ROSA, *Associate Professor*
Fernando MELÍCIO, *Adj. Professor, Ph.D. St.*
Rogério LARGO, *Adj. Professor, Ph.D. St.*
Osvaldo BRASAO, *Ph. D. St.*
Hongfei GONG, *Ph.D. St.*
Cristian MUNTEANU, *Ph.D. St.*
José MALAQUIAS, *Ph.D. St., Teaching Assistant*
Ernesto SOARES, *Ph. D. St.*
João Paulo CALDEIRA, *M.Sc. St., Teaching Assistant*
Rui TAVARES, *PhD. St., Teaching Assistant*
Carlos FERNANDES, *PhD. St, Teaching Assistant*
Nelson PEREIRA, *M.Sc. St.*
Ivo BHATT, *M.Sc. St*
Alexandre CALAPEZ M.Sc. St
Márcio MOURÃO, *M. Sc. St.*

Henrique PEREIRA, *Research Project*
Paulo SILVA, *Research Project*
Pedro SOEIMA, *Undergrad. St*
Nuno COSTA, *Undergrad. St*
Fernando CONTREIRAS, *Undergrad. St*
Marco ERRA, *Undergrad. St*
Pedro MITRA, *Undergrad. St*
Carlos Manuel C CONCEIÇÃO, *Undergrad. St*
João Fernando M COSTA, *Undergrad. St*
Teresa Maria de Andrade ROSADO, *Undergrad. St*
Miguel Reis NAVE, *Undergrad. St*
Paulo Jorge MS APARÍCIO, *Undergrad. St*
Paulo Sérgio da Silva PAIXÃO, *Undergrad. St*
Miguel Angelo de CARVALHO, *Undergrad. St*
Bruno Ricardo Nogueira e SOUSA, *Undergrad. St*
João Marco Cabral Dias SOUSA, *Undergrad. St*
Diogo M GRADE, *Undergrad. St*
Eduardo COUTINHO, *Undergrad. St*

MOBILE ROBOTICS :

Maria Isabel RIBEIRO, *Associate Professor, ISR/IST Vice - Director*
João SEQUEIRA, *Assistant Professor*
Alberto VALE, *Ph.D. Student*
Francisco Melo, *Ph.D Student*
Sérgio GUERREIRO, *M.Sc. Student*
Inácio ROCHA, *M.Sc. Student*
Zlatan TATAROV, *M.Sc Student*
Carlos ALFARO, *M.Sc Student*
Armando FONSECA, *Student*
Luis JORGE, *Student*
Ricardo FERREIRA, *Student*
Pedro SOARES, *Student*

SIGNAL PROCESSING: (IST)

Victor BARROSO, *Associate Professor*
 Isabel LOURTIE, *Associate Professor*
 Jorge S. MARQUES, *Associate Professor*
 Carlos BISPO, *Assistant Professor*
 Pedro M. Q. AGUIAR, *Assistant Professor*
 Francisco GARCIA, *Assistant Professor*
 João Pedro GOMES, *Assistant Professor*
 João XAVIER, *Assistant Professor*
 João SANCHES, *Assistant Professor*
 Paulo GONÇALVES, *Ph.D., Visiting Researcher*
 Sebastien BAUSSON, *Post-Doc*
 Pierre BORGNAT, *Post-Doc, Visiting Researcher*
 Jacinto NASCIMENTO, *Post-Doc*
 Jorge BARBOSA, *Ph.D. St.*
 Jorge SILVA, *Ph.D. St.*
 Marko BEKO, *Ph.D. St.*
 Pedro JORGE, *Ph.D. St.*
 Nuno ORFÃO, *Ph.D. St.*
 Manuel VIEIRA, *M.Sc. St.*
 Paulo LOPES, *M.Sc. St.*
 Tiago PATRÃO, *M.Sc. St.*
 Tiago BARROSO, *M.Sc. St.*
 Rui F. C. GUERREIRO, *M.Sc. St.*
 Bernardo E. PIRES, *Undergrad. St.*
 João PEREIRA, *Undergrad. St.*
 João LEONARDO, *Undergrad. St.*
 João SOUSA, *Undergrad. St.*

SIGNAL PROCESSING : (U.ALGARVE)

Sérgio JESUS, *Associate Professor*
 Hans du BUF, *Invited Associate Professor*
 Hamid SHAHBAZKIA, *Assistant Professor*
 Orlando C. RODRIGUEZ, *Assistant Professor*
 Mário C. M. JESUS, *Adjoint Professor*
 António João SILVA, *Adjoint Professor, Ph.D. St.*
 Paulo FELISBERTO, *Adjoint Professor, Ph.D. St.*
 Robert LOKE, *Ph.D. St.*
 João RODRIGUES, *Ph.D. St.*
 Luis SANTOS, *Ph.D. St.*
 Pedro GUERREIRO, *Ph. D St.*
 Roberto LAM, *Ph. D. St.*
 Cristiano SOARES, *Ph. D St.*
 Nelson MARTINS, *Ph. D St.*
 Filipe TOMAZ, *Research Assistant*
 Tiago CANDEIAS, *Research Assistant*

DYNAMICAL SYSTEMS AND OCEAN ROBOTICS :

António PASCOAL, *Associate Professor*
 Carlos SILVESTRE, *Assistant Professor*
 Paulo OLIVEIRA, *Assistant Professor*
 Lionel LAPIERRE, *Post-Doc*
 Ettore BARROS, *Post-Doc*
 Rita CUNHA, *PhD. Student*
 Francisco TEIXEIRA, *PhD. St.*
 Sajjad ASL, *Ph.D. St.*
 Reza GHABCHELOO, *Ph.D. St.*
 Danilo CARVALHO, *Visiting Ph.D. St.*
 Rodolfo OLIVEIRA, *M.Sc. St.*
 Nuno PAULINO, *M.Sc. St.*
 José LUCAS, *M.Sc. St.*
 Alex PENA, *Res. Engineer*
 Luis SEBASTIÃO, *Res. Engineer*
 Manuel RUFINO, *Res. Engineer*
 José VASCONCELOS, *Res. Engineer*
 João ALVES, *Res. Engineer*
 Guilherme LIBÓRIO, *Technician*

ADMINISTRATIVE STAFF:

Filomena VIEGAS
 Loic BAMDÉ
 Nuno SENA

AERONAUTICS :

Luís M. Braga da Costa CAMPOS, *Full Professor*
 Fernando P. LAU, *Assistant Professor*
 Paulo J. S. GIL, *Assistant Professor*
 Pedro M. V. MIRANDA MENDES, *Colaborator*

2.2 CURRENT RESEARCH INTERESTS

The Lisbon pole of ISR is internally organized in 7 laboratories/groups. In this section the main research interests of each one of the Laboratories/groups are briefly described.

2.2.1 INTELLIGENT SYSTEMS LAB (IS)

The ISLab driving theme is the Research and Development on Multi Robotic Agent Systems and involves the following research topics:

Multi Agent Systems - to study formal modelling tools adequate to develop and organize a team capable of dealing with complex and dynamic environments, working coherently as a group of agents, handling different and even opposite views of the world and the problem within the team, allowing flexible communication among team members, evaluating the team performance and implementing re-organization strategies to handle unexpected situations.

Hybrid and Discrete Event Systems - for robotic task modelling, supervision and coordination, so as to provide means for analysis and synthesis from desired qualitative and quantitative specifications, such as the absence of deadlocks or live locks, unreachable unsafe states, deterministic or probabilistic execution time.

Cooperative Reinforcement Learning - as an approach to iterative stochastic decision making during the coordinated execution of robotic tasks, without full knowledge of the environment model, as well as a quantitative evaluation of robotic task performance.

Formation Guidance, Control, Navigation and Coordination - GNC methodologies for several robots in formation, including free flyers and land robots, as well as its coordination with the task under execution.

Emotion-based Agents - to study methodologies for developing emotion-based agents, which is an entity whose behaviour is guided by taking into account first a rough evaluation of a stimulus goodness and badness, and then an identification of the stimulus based on past experiences. A complementary goal for this research is to study how an emotion-based architecture might be articulated with a classical rational-based architecture.

The group is currently interested in applications to *Soccer Robots*, *Rescue Robots*, *Manufacturing Systems*, and *Satellite Formations*.



Left: drawings for new soccer robots; Right: current soccer robots.

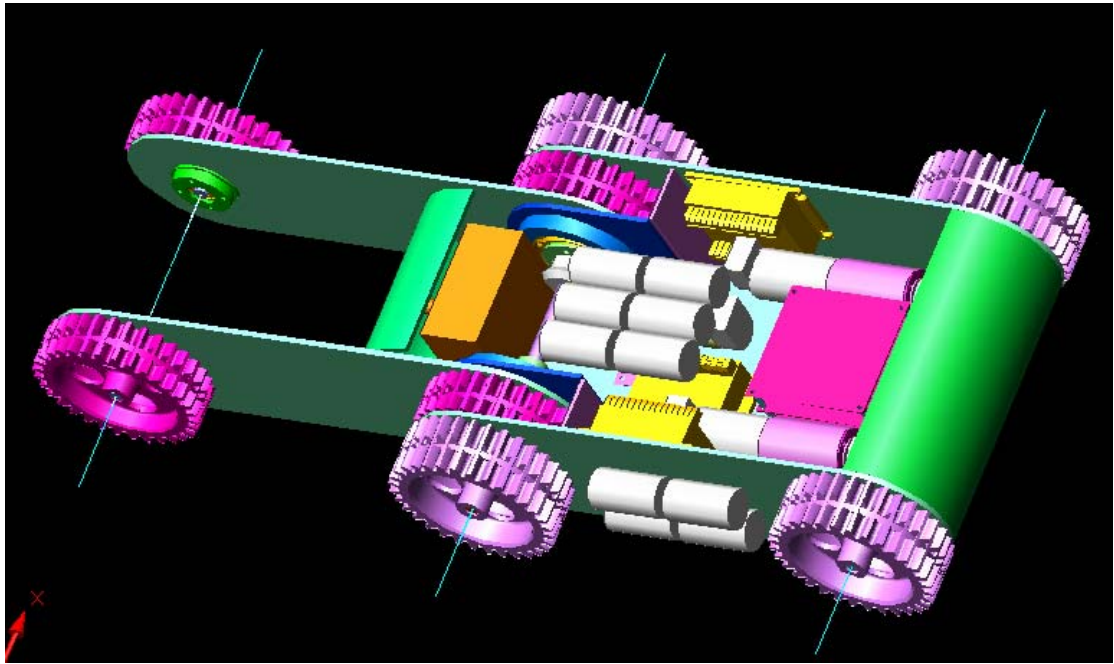

CAD Drawing for RAPOSA Rescue robot

2.2.2 COMPUTER AND ROBOT VISION (VIS)

The research conducted in the Vislab is organized in two main lines:

- **Vision Based Control and Navigation**
- **3D Motion analysis and Reconstruction**

When a camera is moving in a static (or dynamic) environment, the image sequence conveys information regarding the scene/objects structure and camera/objects motion.

In the theme of *Vision Based Control and Navigation*, we address the fundamental problems of understanding what *relevant* information can be extracted from the image sequences to *control* a robot in order to perform a *given task*. This has long standing research line of the Vislab including the control of extremely varied systems like the active control of a binocular head, a learning-by-imitation humanoid-robot, vision based navigation for land, aerial and underwater vehicles and teleoperated cellular robots. From the foundation, VisLab has addressed the control of Binocular Systems and a land mobile robots. More recently, the research was extended to vehicles moving in the 3D space, such that the interplay between the vehicle's degrees of freedom and the scene structure is significantly richer. Example applications have focused on lighter than air blimps and underwater vehicles, in the context of European Research Projects. One distinctive aspect is the search for alternative imaging geometries, often inspired after biological findings. Extensive work has been carried out in the domain of using omnidirectional images for navigation and control as well as for map building for indoors robots. In addition, we have pursued the usage of non-metric maps for navigation like topological maps for structured environments and video mosaics for underwater navigation. Recently, this line of work has evolved towards more cognitive systems, where the vision systems should learn from the observations over long periods of time. Two examples of this motivation lie in the areas of video surveillance and adaptive and developing sensorimotor coordination.

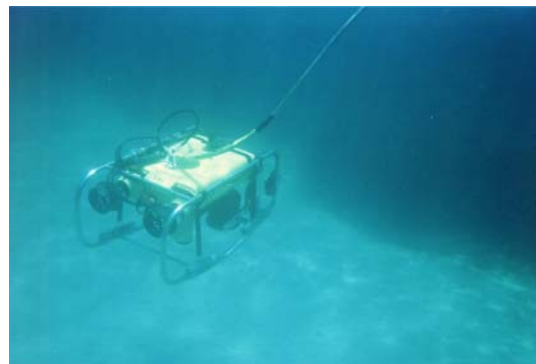
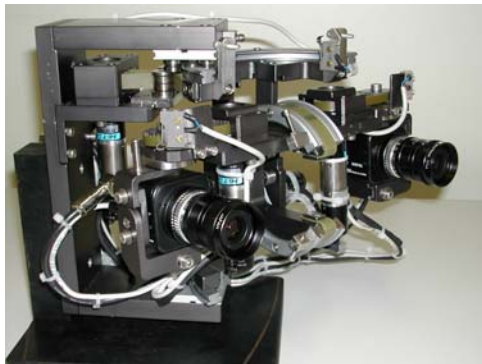



The theme of *3D motion Analysis and Reconstruction* is devoted to the geometry of retrieving information about the scene structure or camera motion from video sequences. Work has addressed the problem of estimating the 3D motion of a camera from an image sequence. Several visual cues were exploited for this purpose: the visual motion and occlusions. Regarding 3D reconstruction, work has focused on developing optimal approaches for matching image features, which is a key step in most 3D vision systems. In addition, the depth estimation process has been formulated in an optimal way by itself. Another line of research has been the reconstruction of structured scenes (e.g. buildings) making use of auxiliary geometric information provided by the user.



Research in all these topics has been carried out both at the level of the fundamental methodologies and also for applications. As the knowledge in these various aspects matures inside the group, research projects have been proposed, including national and European Projects.

2.2.3 MOBILE ROBOTICS (MR)

The Mobile Robotics Lab activities focuses on the research, development and testing of robotic tools applied to the control and navigation of autonomous mobile robotics.

In this Laboratory we are particularly interested in the issues of:

mobile robot navigation, in structured and semi-structured environments,
cooperation/colaboration among multiple robotic devices,
robotics and information systems.

- **Mobile robot navigation:** Study of navigation methodologies for the operation of mobile robots in structure and semi-structured indoor environments, including environment representation, obstacle detection and avoidance, path planning, trajectory finding, motion control and localization. Different sensors are used, namely ultrasound and laser. The group is most interested in the establishment of new sensor and world representations aiming at simplifying the navigation tasks, namely to overcome the absolute localization required in most tasks. The study of probabilistic approaches for the Simultaneous Localization and Map Building, SLAM, in outdoors environment, together with hybrid environment representation, aiming at outdoors operations is currently under study.
- **Cooperative robotics:** Study of the control of multiple heterogeneous robots (mobile platforms and manipulators) acting together towards the fulfillment of an assigned task. Behavior-based approaches to the control of each single robot and multi-robots are considered using tools from algebraic group theory. These led to conceptual control architecture of hybrid nature, with a supervisor modeled by a finite discrete automaton and a set of classes of continuous models modeling robot motion. A distinctive feature of these continuous models is that they accept (in the sense that an assigned mission can be successfully executed) a broad range of robot trajectories. A different addressed issue relates with cooperative navigation and cooperative SLAM.
- **Robotics and information systems:** Information systems are one of the cornerstones of most of the modern organizations. Furthermore, the use of CASE tools in organizations management/operation led to the development of abstract modeling languages of which one of the most widely used is UML (Universal Modeling Language). The biological inspiration has been used in many areas of robotics, such as sensors and robot control architectures. Furthermore, the recent explosion of cooperative robotics is also absorbing paradigms from social evolution models to minimize the complexity of the problem. A similar approach was followed to design a robot control architecture based on a business modeling framework. Unlike the classical approach, this robot control architecture is defined for each mission assigned to the robot and it is revised each time an event in a pre-specified set is triggered. It is also expected that the overall methodology can be applied to robot teams.

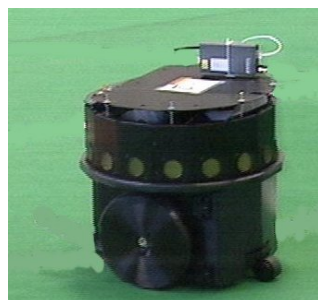

2.2.4 SIGNAL AND IMAGE PROCESSING (SP)

- **Statistical Array and Signal Processing**
- **Wireless Communication Systems**
- **Underwater Acoustic Data Communications**
- **Detection and Estimation Theory**
- **Time-Frequency Signal Analysis and Processing**
- **Navigation and Guidance of underwater vehicles**
- **Image Processing**
- **shape analysis**
- **video surveillance**
- **pattern recognition**
- **Image analysis**
- **Computer vision**
- **Video processing**
- **Multimedia signal processing**

Since september 2003, an informal research project about "Non-Stationarity Of Any Kind" (NSOAK) regroupes P. Borgnat (post-doctoral fellowship from INRIA, France), P. Gonçalves (researcher on leave at ISR from INRIA Rhône-Alpes), S. Bausson (post-doc ISR), P. Mónica Oliveira (Portuguese Naval Research) I. Lourtie (Professor IST) and F. Garcia (Professor IST).

Research themes of NSOAK are:

- Sparse Continuous Wavelet Inversion (P. Borgnat and P. Gonçalves)
- Empirical Mode Decomposition in 1D and 2D (P. Gonçalves and S. Bausson)
- Adaptive Diffusion for Affine Time-Frequency Distributions (P. Gonçalves, in collaboration with Laboratory LM2S, Troyes)
- Statistical Modeling of Image Symmetries and Stationarization (P. Borgnat)
- Sparse Continuous Wavelet Transform Inversion (P. Borgnat and P. Gonçalves)

2.2.5 EVOLUTIONARY SYSTEMS AND BIOMEDICAL ENGINEERING (ESBE)

The research work of this group focus on biologically inspired new algorithms and paradigms and biomedical signal and imaging processing algorithms. The potential of the results have been demonstrated in applications. A few recent results will be presented below.

- **In the Evolutionary Algorithms:** a new version (JDEAL2) of the Java Distributed Evolutionary Algorithms Library is ready and released. This new version added the Island Distributed Cooperative Computing Models to the library and also a new interface for remote control. Several applications using previous release of JDEAL can switch seamlessly to JDEAL2. A new hybrid Evolutionary Taboo Search Algorithm has been proposed and this algorithm demonstrated its potential by providing several new best and one lower bound benchmark results on JOBSHOP scheduling. A new algorithm, Adaptive Reservoir Evolutionary Algorithms (AREA) has been proposed. This algorithm has been applied to optimize benchmark and specific designed test functions and showed superior performance compared to existing algorithms. The successful adaptation of the Olive Fly Model using Evolutionary Approach has captured the interest of the National Plant Protection Department, where is under negotiation the implementation of a nation wide simulation and decision support system based on this concept. Hybrid method of Protein/base Multiple Sequence Alignment is in final stage of benchmarking. Suite of web technologies using evolutionary approach were developed: Adaptive web pages presentation system without specific users feedback, a semantic search engine with intelligent suggestion for surfing and a intelligent and adaptive web servers with all the necessary edition tools. New functional extensions of explicit cooperation were added to the Artificial Life Gaia simulator.
- **In the Biomedical Engineering** area, the Feature Network method is proposed, it is a new object acquisition, representation and reconstruction process which display translation and rotation invariance and tolerance to scale and perspective changes. A new algorithm has been proposed to segment regions in confocal microscope FRAP images of cells using a new distortion and noise model. The group also contributed to the research and normalization of the new Cyclic Alternating Pattern paradigm for sleep microstructure. A new paradigm for Classification and Dynamic organization of Phasic Events in the Sleep EEG will be investigated.

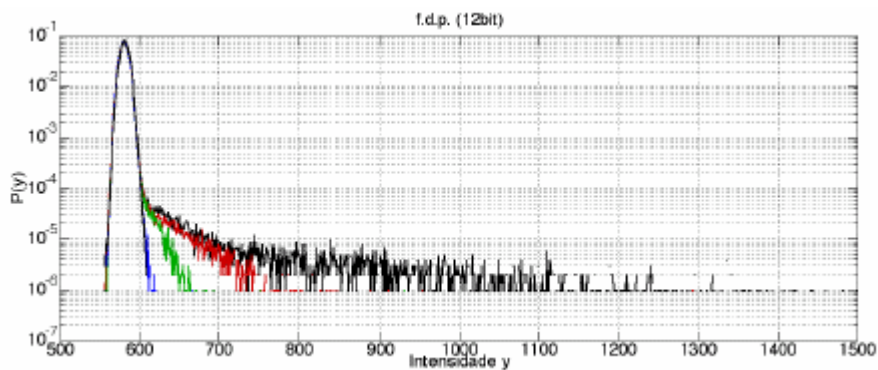

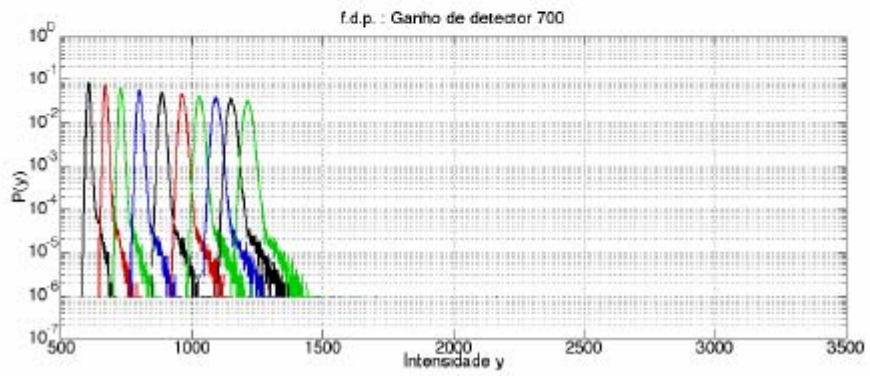
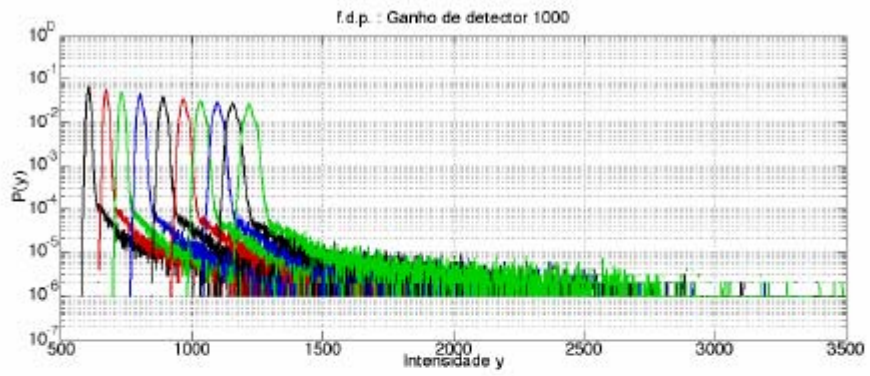

Different Noise Models for FRAP image Processing and Segmentation

2.2.6 DYNAMIC SYSTEMS AND OCEAN ROBOTICS (DSOR)

The key objectives of the research and development work carried out at the Dynamical Systems and Ocean Robotics Laboratory (DSORL) of ISR are *fourfold*:

- Contributing to furthering the knowledge in the general area of *dynamical systems theory*, with a special focus on nonlinear robotic systems *modeling* and *robust and adaptive control*.
- Developing new analysis and design tools in the fields of *navigation, guidance, and control (NGC)*, and applying them to the development of highly performing systems for autonomous air and marine robots.
- Advancing the development of software and hardware for the development of prototypes equipped with real-time operating systems for *Mission Control*.
- Developing tools for *acoustic and scientific equipment interfacing*; performing actual missions at sea to transition from the laboratory to the real world and to foster the *symbiosis between marine science and technology*.

In 2003, and as a natural continuation and expansion of the main lines of research adopted over the past few years, the *research* work done at the DSORL targeted the following areas:

- i) advanced *linear and nonlinear system theory* with applications to the development of new methods for autonomous vehicle navigation, guidance, and control.
- ii) *nonlinear control theory* with applications to coordinated control of multiple autonomous vehicles in the presence of severe inter-vehicle communication constraints.
- iii) *modeling and parameter estimation* of air and marine robots with a view towards the development of integrated plant-controller optimization methods.
- iv) study of hybrid systems and related *hardware and software architectures* for *mission control* of robotic vehicles.

So far, the *development* work has led to the construction of the robotic ocean vehicles DELFIM (an autonomous surface Catamaran), INFANTE (an autonomous underwater robot), and CARAVELA (an autonomous oceanographic vessel). Currently, DSORL participates in the development of the DREAM ROV (remotely operated vehicle), the miniaturized MAYA AUV (autonomous underwater vehicle), and the IRIS (automatic surveying tool). These vehicles and tools play the dual role of i) *advanced testbeds*, to field test new system theoretical concepts and hardware / software architectures for autonomous vehicle control, and ii) *platforms for actual operations at sea*, effectively paving the way for a fruitful symbiosis between marine science and technology.

The DSORL is involved in a number of projects and concerted actions with national and foreign institutions with the objective of advancing engineering methodologies and equipments to the point where they can be used as versatile tools to expand our understanding of the oceans. Representative institutions include the following:

- Department of Mechanical Engineering and Aeronautics, Naval Postgraduate School, Monterey, CA (USA).
- Istituto Automazione Navale, Genova (Italy).
- National Institute of Oceanography, Goa (India) - a memorandum of understanding has been signed by NIO and ISR.
- Department of Engineering Cybernetics, Norwegian University of Science and Technology (NTNU), Trondheim, Norway.
- IFREMER (French Institute for Ocean Exploitation), France.
- Department of Electrical Engineering of the University of Genova (Italy).
- Department of Innovation Engineering, Univ. Lecce (Italy).
- IMAR/DOP/UAçores - Department of Oceanography and Fisheries of the University of the Azores (Portugal).
- CREMINER - The Geology Center of the Faculdade de Ciências da Universidade de Lisboa (FCUL).
- Instituto Geológico e Mineiro (IGM-Geological Survey of Portugal)
- Laboratório Nacional de Engenharia Civil (Portugal).

Privileged links have been established with the IMAR/DOP/UAçores and CREMINER/FCUL, under Theme A (Techniques for Ocean Exploration) of the Laboratório Associado (Associated Laboratory) that is coordinated by ISR. At a technological level, this concerted effort is in line with the current trend worldwide, aimed at the development of

ocean sampling networks (OSN) providing a nested ocean observation capability through the coordinated control of many, mobile, networked sensor platforms. This trend shows clearly that advancements in marine robotics, communications, and information systems are steadily being brought to bear on the development of technologies to enable safer, better, faster, and far more efficient methodologies for the study of the oceans. At the same time, the plethora of engineering problems that must be tackled and solved in the context of ocean research pose considerable challenges to theoreticians and system designers.

This concerted effort aiming at the symbiosis between marine science and technology culminated with the successful realization of a mission in the Azores during the Summer of 2003, over a period of three weeks, that witnessed the operation of the INFANTE AUV in the Pico Canal in cooperation with the IMAR/DOP/UAçores, which provided the scientific expertise required and the logistic means. The pictures and diagrams below illustrate different phases of the mission, together with high-resolution bathymetric maps of selected marine reserve areas obtained with the acoustic data acquisition / navigation systems developed at ISR/IST.

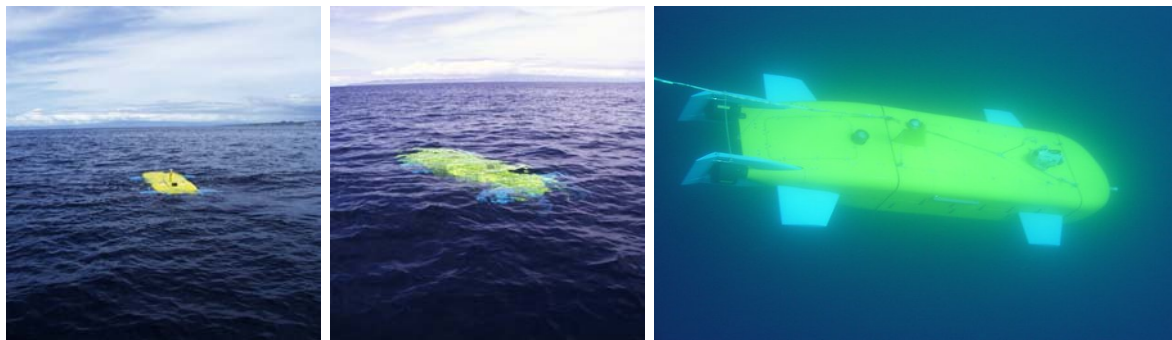

The INFANTE Autonomous Underwater Vehicle during a mission at sea in the Azores – in cooperation with the IMAR/DOP/University of the Azores (summer of 2003)

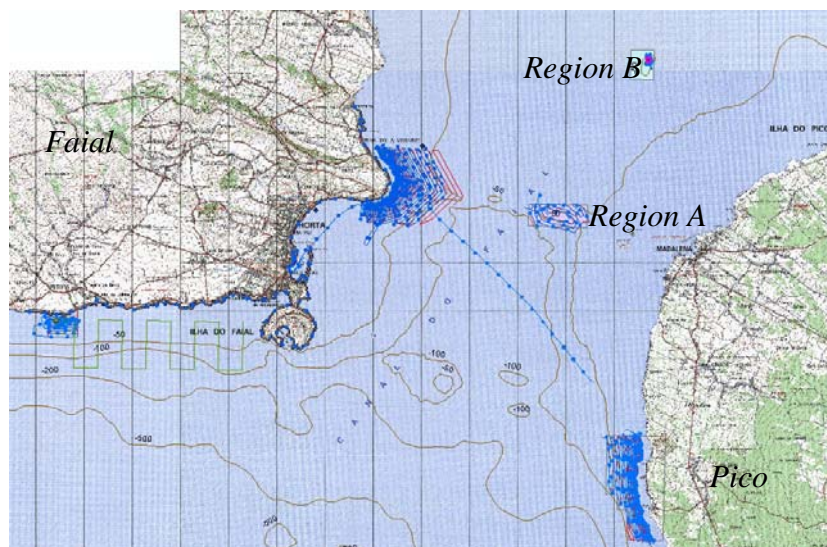

The PICO Canal, between the islands of Faial and Pico, Azores
Surveyed areas are marked in blue

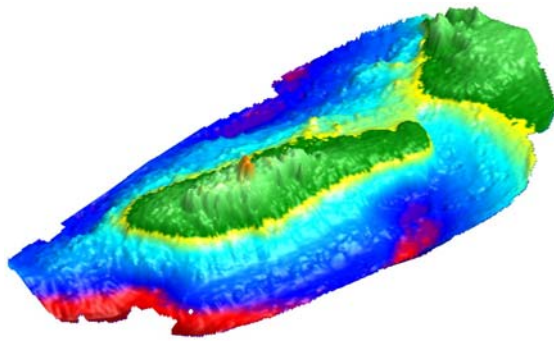

A- Northern Seamount

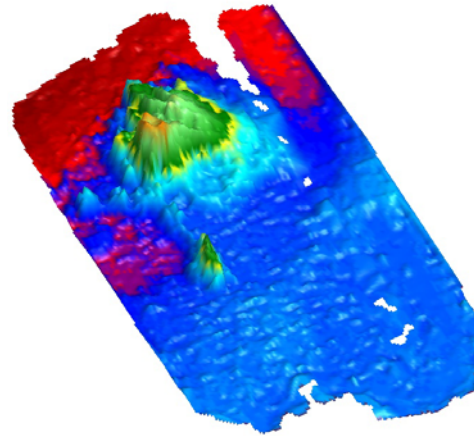

B - "Piedade" Seamount

Bathymetric Maps of Regions A and B (seamounts)
obtained with a mechanically scanning pencil beam sonar

Over the past two years, as a natural consequence of a longstanding collaboration program with the Department of Aeronautics and Astronautics of the Naval Postgraduate School of Monterey, California, USA, the DSORL has started to apply some of the methodologies and technologies developed for ocean vehicles to the control of air robots (helicopters). This is justified in view of the increasing interest worldwide in the use of unmanned aerial robotic vehicles to perform airborne surveying tasks. As part of this effort, the DSORL has been instrumenting an unmanned robotic helicopter that will serve as an advanced platform for NGC (navigation, guidance, and control) system design, implementation, and testing. The platform is based on an industrial radio controlled helicopter that was equipped with a distributed real time computing network, a reliable wireless communication system, and sensing devices. The activity pursued in this area is well rooted in scientific applications that require the use of autonomous air robots to accurately map coastal areas subjected to erosion, using airborne laser altimetry. In particular, project ALTICOPTER funded by the FCT envisions the use of a helicopter to map sand dunes along the Portuguese coast.

The work reported touches upon theoretical and practical issues. The balance between the two factors is often hard to strike and requires the concerted action of many researchers / engineers, with expertise that runs across a number of technical fields. In 2003, 12 MSc, PhD, and Postdoc students, as well as 3 members of the technical staff of IST were involved in the study of theoretical problems related to air and marine robotics; 5 hired Research Engineers, among which 3 (Luis Sebastião, Manuel Rufino, and J. Alves) are senior researchers, have contributed very positively to the research and development program of DSORL by tackling more practically oriented problems in the fields of vehicle and system development, as well as operations at sea.

At a *theoretical* level, the main lines of research that are being pursued at the DSORL are the following:

1. Linear and Nonlinear Systems Theory: Navigation, Guidance, and Control.

1.1 Robust Multiple-Model Adaptive Control (RMMAC): A New Paradigm for Robust Control System Design

The work of doctoral student Sajjad Asl, supervised by Profs. Michael Athans and António Pascoal, has led to a novel Robust Multiple-Model Adaptive Control (RMMAC) architecture that explores an interesting and fruitful set of ideas set forth by Prof. Michael Athans. The new structure for robust control combines and integrates sophisticated identification methods and the state-of-the-art in robust control synthesis, using the mixed \square - *methodology* for robust control of linear time-invariant systems subject to structured and unstructured uncertainty. The proposed RMMAC method does not seem to suffer from some of the *ad-hoc* design choices associated with the recent literature of using switching controllers using multiple-models. Moreover, RMMAC focuses upon *robust-stability and robust-performance*. So far, the performance of RMMAC has been evaluated using non-trivial simulation examples.

The RMMAC architecture differs from traditional MMAC approaches, because the local state-estimate generated by each Kalman filter (in a Multiple Model Adaptive Estimation - MMAE - setting) is not used in the robust compensator implementation. Only the posterior probabilities reflect the system identification. The probabilistic weighting of the "local" robust control signals, based upon the numerical results obtained so far, appears to cause the RMMAC algorithm to work in a far more predictable manner and to significantly improve disturbance-rejection (if at all possible) over non-adaptive robust designs. From an engineering point of view, the work carried out has suggested procedures to quantitatively predict the potential performance improvements that come from using RMMAC, both in the frequency and time domains, by using variance analysis completely off-line, and without any Monte Carlo simulations. Such a capability provides extremely valuable insight because an engineer must always trade-off increased controller complexity with potential performance improvement.

It is important to point out that the field of nonlinear control lacks a general theory for global stochastic stability theory for nonlinear time-varying systems with unmodeled dynamics, such as the RMMAC. Until such a theory is developed, no global stability guarantees for the RMMAC (or any other available adaptive algorithm) can be given. This is a topic of considerable interest that warrants future research efforts. Future work will also address the application of the RMMAC methodology to the control of marine vehicles subjected to large parametric uncertainty.

1.2 Control of Marine Vehicles using Output Feedback Techniques

The importance of output feedback control strategies cannot be overemphasized: in practice, it is often *impossible, difficult, or simply too costly to measure the full state vector of a given plant*. This motivates the development of controllers that rely on output variables only, effectively increasing the simplicity and thus the reliability of the control laws adopted. In the case of the INFANTE AUV, for example, it is difficult to measure the angle of sideslip and the angle of attack in the horizontal and vertical planes, respectively. However, it is crucial to achieve stabilization and high vehicle performance in both planes. Thus, the use of output feedback control to meet tight stability and performance criteria is warranted. This motivated the study of control techniques for the INFANTE AUV using Gain Scheduled Static Output Feedback in the scope of joint research activity by Profs Carlos Silvestre and António Pascoal. The methodology adopted for controller design was nonlinear gain scheduling control, whereby a set of *linear finite static output feedback controllers* was designed using Linear Matrix Inequality (LMI)-based techniques and scheduled on the vehicle's forward speed. Linear control system design built on static output feedback (SOF) techniques. This procedure led naturally to control laws with a very simple structure, since the controllers do not exhibit any dynamics except those introduced by appended integrators that aim at reducing steady state tracking errors to zero. Experimental tests with the actual vehicle at sea confirmed the type of performance that was predicted using numerical simulations. Future work will address yet unsolved theoretical questions in the area of output feedback control systems design.

1.3 Integrated Guidance and Control Systems Design.

Guidance and Control are the basic systems that enable an autonomous platform to maneuver along pre-defined paths. Research at ISR/IST in the area of integrated guidance and control systems was initiated years ago, leading to a sequence of results that were published in the literature. The publications illustrate the application of the techniques developed to both aircraft and marine vehicles. In 2003, work along these lines was carried out by doctoral student Rita Cunha under the supervision of Prof. Carlos Silvestre, and led to an Integrated Guidance and Control strategy for Autonomous Helicopters. The strategy developed builds on the definition of an adequate generalized error space where the dynamics and kinematics of the Helicopter are expressed. The path following problem is then cast and solved in the framework of gain scheduling control theory, using the so-called D-methodology. The resulting control law ensures that: i) the path following system achieves zero steady state tracking error about trimming trajectories, and ii) the linearizations of the nonlinear gain scheduled feedback system and the corresponding linear designs present the same internal as well as input-output characteristics. Controller performance was evaluated in simulation, using the helicopter nonlinear dynamic model SimModHeli, conveniently parameterized for the Vario X-treme model-scale helicopter.

1.4 Terrain Tracking Systems

Terrain tracking is a challenging problem and one of utmost importance for the safe operation of both air and underwater vehicles. In 2003, a new methodology for terrain tracking guidance and control strategies with application to autonomous helicopters was developed under a cooperative research effort by G. Libório, MSc student N. Paulino, PhD student R. Cunha, and Profs C. Silvestre and M. I. Ribeiro. This methodology amounts to augmenting the discrete state space model of the plant with terrain preview data. The terrain information is obtained by applying a 2D

reconstruction technique to the measurements taken by a forward looking laser range scanner. The resulting control problem was solved using the discrete time Stochastic Linear Quadratic Regulator where the particular structure of the augmented system is explored to simplify the computation of a feedforward gain matrix. This methodology was successfully applied in simulation to the full nonlinear dynamic model of the Vario X-Treme acrobatic helicopter. Future work will aim at extending the methodology derived to terrain tracking (also called bottom following) of underwater vehicles, using acoustic sonar data.

1.5 Navigation and Positioning Systems

Remotely Operated Vehicles (ROVs) and, more recently, Autonomous Underwater Vehicles (AUVs) have shown to be extremely important instruments in the study and exploration of the oceans. Free from the constraints of an umbilical cable, AUVs are steadily becoming the tool *par excellence* to acquire marine data on an unprecedented scale and, in the future, to carry out interventions in undersea structures. Central to the operation of these vehicles is the availability of accurate *vehicle navigation and/or positioning systems*. *Navigation* refers to the problem of computing the linear position and the attitude of an underwater platform and the respective linear and rotational rates. By *positioning* it is simply meant the problem of computing the position of an underwater platform.

Navigation is probably the hardest and most complex task underwater. In fact, once a platform submerges, it ceases to have GPS fixes and accurate navigation can only be achieved by resorting to either a true inertial system or to the integration of moderate cost attitude and heading reference units with complementary systems that rely on the propagation of acoustic waves (long and short-baseline systems, Doppler units, etc.). The first option is prohibitive and clearly not an option if one is to develop underwater robots with a strong impact on a wide range of scientific and commercial operations. The second option requires fusing data from different sources, dealing with multipath effects and drop-outs, and addressing explicitly the problems that arise because data are available with variable latency (due to the finite speed of propagation in the water) and at different sampling frequencies (multirate characteristics).

At ISR/IST, navigation system design has been typically approached using the theory of multi-rate, polytopic, and linear parametrically varying systems, as set forth in the PhD thesis of Prof. Paulo Oliveira. The main goal is to develop methodologies that can afford system designers with frequency-like design / analysis tools, thus extending to the time-varying and nonlinear setting the highly practical and intuitively appealing complementary filtering structures. The applications envisioned fall in the areas of marine and even air robotics. Some of the algorithms developed have been tested at sea during missions with the Delfim autonomous surface craft. In 2003, and in order to bridge the gap between theory and practice of navigation, work continued on the *improvement of a moderate cost heading and attitude reference to test advanced navigation algorithms*. This development work, carried out by José Vasconcelos and Guilherme Libório under the supervision of Profs Paulo Oliveira and Carlos Silvestre, proved quite valuable in terms of evaluating different types of accelerometers and mechanical / fiber optic gyros, as well as hands on experience on the design and development of a unit that will equip future platforms, using hardware for real time distributed systems that is proprietary of ISR/IST. At the same time, the work focused also on the design and implementation of a series of methods ("Kalman smoothing" algorithms) for post-processing of data obtained at sea, using navigational information. This proved instrumental in the geo-referencing of the bathymetric data acquired during the sea missions performed with one of the autonomous vehicles of ISR/IST and the research surface vessel of the Univ. Azores. This work was carried out by Research Engineer Luis Sebastião and Prof. Paulo Oliveira.

Positioning. Classical approaches to underwater vehicle *positioning* include the use of Long Baseline (LBL) and Short Baseline (SBL) systems, to name but a few. More recently, a number of methods have been proposed to "reproduce" the idea of GPS in the underwater environment. For example, a system consisting of surface buoys equipped with DGPS receptors that broadcast satellite information underwater, via acoustic telemetry. The underwater vehicle receives these messages from the buoys and computes its own position locally. Due to the technical difficulties inherent to acoustic communications, this concept has not yet materialized in the form of a commercial product. A different, yet related approach to acoustic underwater positioning has actually been implemented and is available commercially: the so-called GIB system (GPS Intelligent Buoy system), which was purchased by ISR/IST. This system consists of four surface buoys equipped with DGPS receptors and submerged underwater hydrophones. Each of the buoys receives the acoustic impulses emitted periodically by a synchronized pinger installed on-board an underwater vehicle and records their times of arrival. The buoys communicate via radio with a central station (typically on-board a support vessel) where the position of the underwater vehicle is computed. Due to the fact that position estimates are only available at the central station, this system is naturally suited for tracking applications. Unfortunately, the algorithms for target tracking available with the commercial unit exhibit poor performance.

In view of this, and given the very good quality of the hardware purchased, it was decided to re-do the algorithms to obtain a system capable of yielding precise estimates of the position of an underwater vehicle given a set of ranges from the UV to known buoy locations. Classically, this problem is solved by resorting to triangulation techniques, which require that at least three range measurements are available at the end of each acoustic emission-reception cycle. This is hardly feasible in practice, due to unavoidable communication and sensor failures. It is therefore of interest to develop an estimator structure capable of dealing with the case where the number of range measurements available is time-varying. This was done by tackling the problem in the framework of Extended Kalman Filtering (EKF), whereby the vehicle-to-buoy range measurements drive a filter (tracker) that relies on the kinematic model of the underwater vehicle. It is important to recall that due to the finite speed of propagation of sound in water, the range measurements are obtained at the buoys with different latencies. To overcome this problem, a methodology was developed that utilizes the measurements as they arrive, by incorporating a backwards and forward fusion approach. Simulation, as well as preliminary experimental results obtained in the scope of work carried out by the research engineer Alex Penas, together with Profs Paulo Oliveira and António Pascoal, illustrate the performance of the filter proposed. Its practical implementation and full testing at sea will take place in 2004. Future work will address the integration of the modified GIB system with the dead reckoning navigation system existent on-board the underwater vehicle. In this configuration, position estimates will be periodically transmitted to the underwater platform via an acoustic modem.

Landmark Based Navigation. In the two above problems, navigation and positioning are done with respect to an inertial reference frame. In that case, the navigational accuracy achieved is directly related to the quality of the equipment used. Unfortunately, there simply is no remedy to this situation when the vehicles executes missions in open water, far away from the seabed and the sea surface, that is, with no clear landmarks "on sight". The situation is completely different when the vehicle is asked to repeatedly survey an area where there are conspicuous landmarks (e.g. conspicuous terrain features, strong magnetic or gravimetric signatures, etc.). In this case, it is best to try and use this information to develop navigation system capable of correcting for the drift that is inherent to "inertial navigation-like" systems. In line with these comments, during 2003 the doctoral student Francisco Teixeira carried out research on the subject of underwater vehicle navigation using bathymetric (that is, seabed depth) information by exploring key concepts that borrow from the field of SLAM (Simultaneous Localization and Mapping). In his work, he has derived a special type of particle filter that effectively merges information provided by a Doppler log, an attitude unit, and an echosounder. Encouraging simulation results obtained with a digital terrain map of the D. João de Castro seamount show the potential of the filter to the development of terrain based navigation systems. Future work will address the use of more than one echosounder or a multibeam sonar to explore spatial diversity, as well as the magnetic signature of the terrain being covered for local navigation.

2. Coordinated Motion Control

In recent years, there has been widespread interest in the problem of coordinated motion control of fleet of autonomous vehicles. Applications include aircraft and spacecraft formation flying control, coordinated control of land robots, and control of multiple surface and underwater vehicles. The work reported in the literature addresses a large class of topics that include, among others, leader/follower formation flying, control of the "center of mass" and radius of dispersion of swarms of vehicles, and uniform coverage of an area by a group of surveying robots. At ISR/IST, there has been considerable research activity in this vibrant area towards the development of algorithms for coordinated motion control of an autonomous underwater vehicle (AUV) and an autonomous surface craft (ASC). In this scenario, an autonomous surface craft (ASC) is required to follow a desired path accurately while an autonomous underwater vehicle (AUV) operating at a fixed depth is required to follow exactly the same horizontal path (shifted in the vertical coordinate), while tracking the ASC motion along that path. See the joint figure.

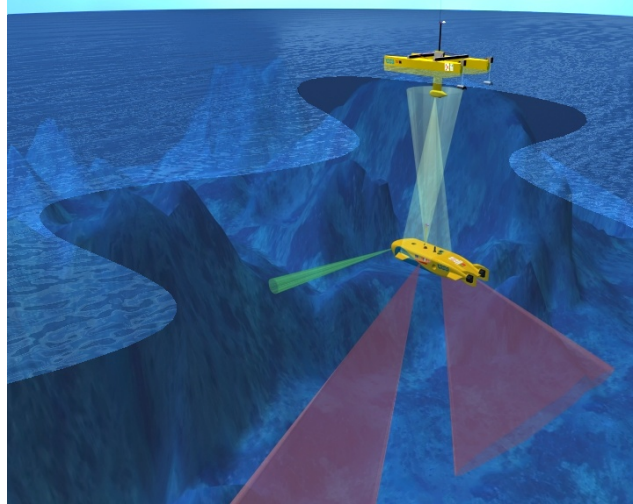

Combined autonomous surface craft / autonomous underwater vehicle control.

In this example, the AUV serves as a mobile sensor suite to acquire scientific data, while the ASC plays the role of a fast communication relay between the AUV and a support ship. Thus, the ASC effectively explores the fact that high data rate underwater communications can best be achieved if the emitter and the receiver are aligned along the same vertical line. Notice how both vehicles are required to follow exactly the same type of path (shifted in the vertical), which is imposed by the scientific missions at hand.

This and similar problems have been posed for the first time and tackled in the scope of the PhD thesis of former student Pedro Encarnação and more recently by post-doctoral students Didik Soetanto and Lionel Lapierre, using Lyapunov and Backstepping-based designs. To distinguish it from other coordinated motion control problems studied in the literature, we refer to it as the *Coordinated Path Following Control* problem.

To the best of our knowledge, previous work on coordinated path following control has been restricted to the area of marine robotics. However, the solutions developed so far for underactuated vehicles are restricted to two vehicles in a leader-follower type of formation and lead to complex control laws, as is clear in the joint publications of Didik Soetanto, Lionel Lapierre, and António Pascoal that appeared in 2003. Related work is also coming out of the group of Prof. Thor Fossen at the NTNU, Norway. However, the control laws derived apply to fully actuated vehicles only and are still quite complex to implement. There is therefore a need to re-examine this problem to try and arrive at efficient and practical solutions for wheeled robots in the hope that the solution derived for this simpler case will shed some light into the problem of coordinated path following for the more complex case of air and marine robots. In an attempt to do this, the work of PhD student Reza Ghancheloo supervised by Profs António Pascoal and Carlos Silvestre, addressed the problem of steering a fleet of wheeled robots along a set of given spatial paths, while keeping a desired inter-vehicle formation pattern. This problem arises for example when multiple vehicles are required to scan a given area in cooperation. In a possible mission scenario, one of the vehicles acts a leader and follows a path accurately, while the other vehicles follow paths that are naturally determined by the formation pattern imposed. However, other inter-vehicle coordination schemes are allowed. His work provides a solution to these problems using a simple algorithm that builds on linearization techniques and gain scheduling control theory. Using this set-up, path following (in space) and inter-vehicle coordination (in time) are almost decoupled. Path following for each vehicle amounts to reducing a conveniently defined error vector to zero. Vehicle coordination is achieved by adjusting the speed of each of the vehicles along its path, according to information on the position of some of the other vehicles only. *No other information is exchanged among the robots.* The set-up adopted allows for a simple analysis of the resulting coordinated path following control system. Furthermore, it provides guidelines to evaluate the behaviour of the formation as a consequence of certain vehicle failures or loss of inter-vehicle communications. His future work will aim at extending the results obtained to marine vehicles and the 3D space. The results obtained are expected to provide some insight into the development of nonlinear control laws so as to ensure global results.

3. Modeling, Parameter Estimation and Identification, and Integrated Plant-Controller Design for Marine Vehicles.

3.1 Integrated Plant-Controller Optimization with Applications to Marine Vehicles Design

The problem of marine vehicle system design to meet desired performance requirements in the presence of stringent energy constraints is basically unsolved. To better grasp the complexity of this problem at hand, consider the situation where one is required to design a marine vehicle with a specified speed and range of operation, to carry scientific instrumentation, and perform data acquisition in 3D. The volume of scientific instrumentation and hotel payload, together with a slack volume for battery and buoyancy arrangements, set a minimum on the enclosed volume of the vehicle. Starting with this value, it is then necessary to define the hydrodynamic shape of the platform and the placement / dimension of the actuators so that: i) vehicle frontal drag is minimized, ii) open loop performance (as evaluated by the location of the eigenvalues of the vehicle's linearization about selected forward speeds) is adequate, and iii) the actuators have enough authority to allow for the design of closed loop controllers to yield adequate behaviour in response to input commands in depth and yaw, external disturbances (currents and sea waves while operating close to the surface, etc.), and sensor noise. It is important to remark that the final volume enclosed by the AUV must allow for the installation of enough battery power to steer the vehicle through the required maneuvers. Thus, we are clearly in the presence of a design cycle that spirals down to a final (hopefully satisfactory) solution.

The difficulty of the problem lies in the fact that the design of the plant and controller should be interwoven, lest a poor mechanical design impose unduly restriction on what can later be achieved with control. Thus the importance of integrated plant-controller design. Similar problems have been addressed in the aeronautics industry, where the reduction of an airplane's weight while preserving its capability to perform desire missions is of paramount importance. Meeting the above objectives for both marine and air vehicles is indeed a challenging problem that has not even been properly formalized yet. Preliminary steps in this direction have been taken in the marine field for the case where the form of the vehicle has been fixed and only the size of the actuators (deflecting surfaces) is allowed to vary (PhD thesis of Prof. Carlos Silvestre). Clearly, one needs to build a long term research plan to tackle and solve the problem posed above. However, in view of the complexity of the problem at hand, it is wise to start by addressing the "simpler" problem of predicting the open loop performance that can be achieved with a marine vehicle, given its geometry and mass distribution.

The above considerations were instrumental in defining a line of research that has received renewed energy during the stay of Prof. Ettore Barros from the Univ. São Paulo, Brasil, at the DSORL. His research program addresses the general problem of autonomous *underwater vehicle (AUV) modeling and parameter estimation* as a means to predict the expected dynamic performance of AUVs and thus guide their design phase well before they can be tested at sea. This will shorten the time of vehicle design and development and reduce drastically the costs associated with intensive hydrodynamic tank tests.

The short term goal of this research effort is to bring together different techniques for AUV parameter estimation that include analytical and semi-empirical methods (ASE) and to use them to predict the hydrodynamic derivatives of a large class of AUVs with conventional, streamlined bodies, in the vertical (dive) and horizontal planes. The long term plan is to complement these approaches with CFD techniques and to evaluate the accuracy of the different parameter estimation methods through a restricted number of tests with reduced or full scale vehicles in hydrodynamic tanks or at sea, respectively. To meet the abovementioned goals, cooperation agreements have been established with the Department of Engineering Cybernetics, Norwegian University of Science and Technology (NTNU), Trondheim, Norway, and the National Institute of Oceanography (NIO), Dona Paula, Goa, India. The NTNU has the facilities required to run hydrodynamics tank tests, while NIO has agreed to run AUV CFD analysis using parallel computing facilities available in India. *So far, the research work carried out has led to a systematic way of predicting the main hydrodynamic derivatives of torpedo shaped AUVs and evaluate their expected open loop performance. An application has been done to the prediction of the hydrodynamic derivatives of one the MAYA AUVs. In the near future, CFD tests will be run in India. A mock-up of the vehicle will be shipped to Norway in 2004 to estimate the derivatives using classical tank testing procedures. Tests with a real vehicle will be carried out by ISR/IST in Portugal. See the diagram below for the interaction among the institutions involved and their expertises.*

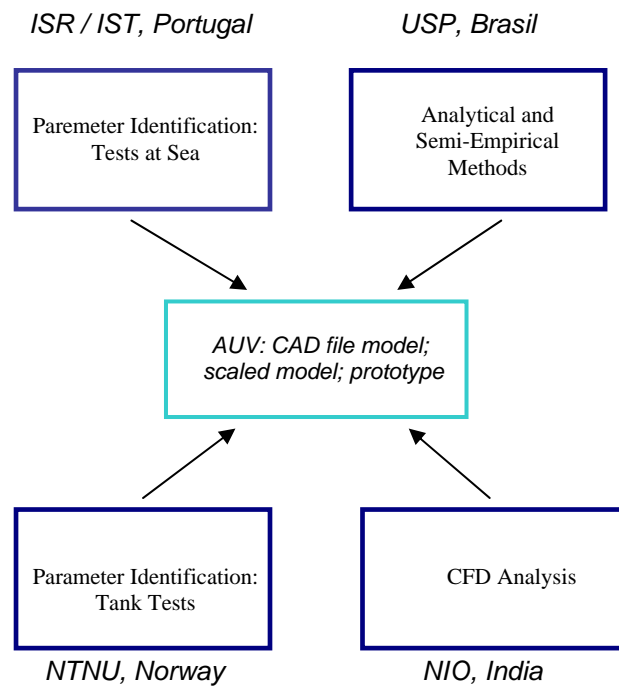

Collaborative research programme on AUV modeling and parameter estimation / identification

The outcome of this work will be comparison and calibration of the methods proposed for hydrodynamic parameter estimation against measured data. Indeed, building confidence on the above methods and evaluating their complementary are important steps towards the development of true plant-controller optimization schemes.

3.2 Modeling of Air Vehicles

The work of PhD student Rita Cunha in the scope of modeling of air vehicles led to the development of an Autonomous Helicopter Dynamic Simulator, named SimModHeli. The simulator is based on an accurate self-contained helicopter dynamic model, derived from first-physics principles, that is specially tailored for model-scale helicopters. The simulation model includes the rigid body, main rotor flapping, and Bell-Hiller stabilizing bar dynamics. Particular emphasis is placed on the analysis of the stabilizing bar and on the evaluation of its impact on the overall helicopter dynamics. The model is parameterized for the Vario X-Treme acrobatic helicopter, within the scope of the ALTICOPTER project, and solutions for a set of trimming trajectories are identified and discussed. Different simplifications, needed to derive models for control system design, were computed, and their influence on the resultant dynamics evaluated. The effect of changing the physical parameters of the stabilizing bar was also studied. The resulting model has proved a valuable tool for control system design and closed loop performance evaluation.

4. Multiple Vehicle Mission Control

At the mission control level, work continued on the development of software and hardware tools for mission programming and mission execution of autonomous vehicles, including cooperative control of surface and underwater vehicles, that is, *multiple vehicle mission control*. The work built on previous development efforts that led to CORAL, a Petri Net software application that is proprietary of ISR/IST and allows for mission programming and running in real-time. In 2003, the main focus of the research work in this area, carried out by MSc student Rudolfo Oliveira under the supervision of Prof. Carlos Silvestre solidified the extension of CORAL to deal with multiple vehicle operation. At the same time, *hardware architectures* continued to be developed for distributed real-time control of ocean robotic vehicles.

The work on Multiple Vehicle Mission Control tackled the problem of autonomous robotic vehicles mission design and execution in distributed environments. All computational phases from mission plan edition and mission program generation to real time mission execution in each of the systems on board the vehicles were addressed. A multi-vehicle mission editor, that composes the mission plan and automatically generates the mission program, is a fundamental tool to autonomous vehicles system designers who strive to develop vehicles that can be programmed and operated by end-users that are not necessarily familiarized with the engineering details of vehicle technology. The mission program is automatically generated from the mission plan and is written in the CORAL Petri Net description language and execution system.

In the solution proposed for Multiple Vehicle Mission Control, all the responsible mechanisms for the interaction among the systems onboard the vehicles, the modeling entities, and the mission plan supervisors are embodied in hierarchical Petri nets. Designing a controller that limits the original Petri net reachable state space then enforces the required behavior of each Petri net building block. The controller, that is itself a Petri net, is synthesized by resorting to the well know concept of place invariant. This technique, together with the hierarchical structure proposed for the mission program, leads to deadlock free mission control strategies, insures liveness, and enforces direct and indirect conditions on allowable events during the mission execution.

The work pursued was the basis for the implementation of the Infante autonomous underwater vehicle mission control system, which was thoroughly tested at sea in the Azores, in 2003 using a Real Time Distributed Computing Network developed at ISR/IST and installed on-board the vehicle and the support vessel.

Cooperation with other ISR Laboratories

During the year 2003, DSORL has continued to explore collaboration links with other Labs of ISR. Namely, the DSORL has participated in the following lines of research:

- Landmark Based Underwater Navigation – the *VISLAB* contribution focused on video mosaicking from video images acquired around the island of Faial, in the Azores.
- Terrain Following of Unmanned Air Vehicles (with the *Mobile Robotics Lab*) – joint work on “Terrain following preview controllers for model-scale helicopters”.
- Underwater Communication Systems (with the *Signal Processing Lab*) – the DSORL Lab is responsible for the integration and testing at sea of the acoustic modems that were developed by the French company ORCA for the INFANTE AUV, by exploring a fruitful partnership with the Signal Processing Lab of ISR. During the tests in the Azores in 2003, an extensive series of tests were carried out to determine the effective range of communications achievable in coastal, shallow water environments.

2.2.7 AERONAUTICS (AERO)

In Aeronautics:

- Flight testing, including development of instrumentation packages;
- Flight dynamics, including non-linear stability and atmospheric effects;
- Flight simulation: installation of a three degree-of-freedom simulator;
- Aerodynamics: installation of an aero acoustic wind tunnel.

In Acoustics:

- Sound generation by aircraft propellers and helicopter rotors;
- Sound propagation in ducts of varying cross-section with flow (nozzles);
- Scattering of sound in shear flows, including boundary layers and shear layers.

In Magnetohydrodynamics:

- Hydromagnetic waves in inhomogeneous and flowing media;
- Applications to solar atmosphere and wind.

In Applied Mathematics:

- Differ integration, i.e. derivatives and integrals of non-integer order;
- Special functions, i.e. extensions of the hyper geometric type;
- Ordinary differential equations with regular and irregular singularities.

3. RESEARCH ACTIVITIES

3.1 RESEARCH PROJECTS

This section contains a brief description of the R&D projects in progress at ISR (Lisbon), IST and University of Algarve during 2004, under the supervision of ISR members. The subsections define the main areas of intervention where the projects are being developed. The projects resulting from contracts celebrated with ISR and managed by this private research institution are identified by (*) on the title; all the remaining projects refer to contracts celebrated and managed by IST and University of Algarve.

3.1.1 UNDERWATER AND OCEAN ROBOTICS

Project name: AUTONOMOUS VEHICLE DESIGN AND CONTROL

Project Leader within ISR: Prof. António Pascoal (IST/ISR)

Project Description: The objective of this research program is threefold: i) to investigate the technologies required for the development of small autonomous underwater vehicles (AUVs), ii) to develop methods for integrated design of underwater vehicles and dynamic controllers, and iii) to study new methodologies for the design of path following control laws for autonomous vehicles as well as for coordinated control of marine robots.

i) Integrated design of underwater vehicles and controllers – the key objective is to study the problems of AUV modeling and parameter estimation in conjunction with control system design, as a means to predict the expected dynamic performance of underwater vehicles under closed feedback control, and thus guide their design phase well before they can be tested at sea. AUV modeling and parameter estimation requires a combination of analytical and semi-empirical methods, together with actual testing of scaled version of vehicle models in hydrodynamic tank facilities. The methodologies explored for control system design are firmly rooted in the field of control systems theory and borrow heavily from the areas of Linear Matrix Inequalities (LMIs) and Convex Optimization, which are the subject of current research.

ii) AUV control under wave disturbances – the main theoretical tools used are stochastic linearization and linear matrix inequalities. The first allow for the computation of the "linear simplified model" of a full stochastic model for the AUV; the latter is specially suited to address multiobjective design criteria such as minimizing the effect of wave action while maintaining sufficient control authority for depth maneuvering and robustness against plant uncertainty.

iii) Path following in 3-D – the key issues in this research topic are the control of ocean vehicles for accurate path following in 3-D and the control of vehicles working in cooperation. The methodologies being used borrow from Lyapunov stability theory.

v) Technologies for the development of small AUVs – this initiative was started in cooperation with the National Institute of Oceanography (NIO) in Goa, India, with the objective of investigating basic technological issues that will play a key role in the development of a future breed of AUVs. The long term objective is for the ISR and the NIO to design and actually build two identical copies of a small AUV that will be used in oceanographic missions in Portugal and India. This is currently being pursued in the scope of the MAYA project.

Research Areas: AUV Dynamics, Hydrodynamics, Parameter Estimation, Control Theory, Combined Plant / Controller Optimization, Coordinated Motion Control of Multiple Vehicles, Distributed Control Architectures, Guidance and Navigation Systems.

Laboratories: DSORL

External Partners: Dept. Mechanical Engineering and Dept. Aeronautics and Astronautics, Naval Postgraduate School, Monterey, California, USA; National Institute of Oceanography (NIO), Dona Paula, Goa, India, Dept. Mechatronics of the University of São Paulo, Brasil.

Initiated: 1996.

Conclusion : on going

Classification: Memorandum of Understanding between the ISR/IST and the NPS of Monterey, California. Memorandum of Understanding between the National Institute of Oceanography and the IISR/IST. Research work has been supported by NATO scholarships, funding from GRICES through the Portuguese-India Cooperation Programme and institutional funding for travel and accommodations.

Documents produced in 2003: [44] , [45] , [46] , [50] , [55] , [56] , [57] , [58] , [115] , [116] , [118] , [119] , [123] , [124] , [127] , [128] , [130] , [131] .



Project name: FREE SUB – AUTONOMOUS UNDERWATER VEHICLE FOR SUBSEA INTERVENTION



Project Leader within ISR: Prof. António Pascoal (IST/ISR)

Project Coordinator: Cybernetix Offshore Department, France.

Project Description: The “ FREESUB ” network addresses the exchange of human resources that are essential to the development of autonomous unmanned sub-sea vehicles (AUVs) for remote intervention on fixed underwater structures. The network’s goal is to aid mobility of scientific researchers, technology transfer, and dissemination of information. The “ FREESUB ” network fosters the exchange of young doctoral and post-doctoral researchers among various EU universities and research institutes. The main technical objective of the project is to contribute to the development of general tools that will in the near future allow autonomous vehicles to navigate to target sites with great precision and to carry out intervention tasks on underwater fixed structures.

In 2003, the work of IST/ISR was focused on the issues of Navigation, Guidance, and Control (NGC) of autonomous underwater vehicles (AUVs). Preliminary steps were also taken towards the development of expertise in the field of Concurrent Mapping and Localization. This research effort led to strong cooperation links with other partners in the network that materialized in two joint publications in which the Young Researcher of IST, Lionel Lapierre, was stated as an author. Also fruit of these cooperation links was the organization of two work sessions in Lisbon with the Young Researcher Zoran URSULOVICI in February 2002 and with the Young Researchers David LABBE, Tien TRAN, and Peter WEISS in June 2002 to discuss issues on Concurrent Mapping and Localization and on a general architecture for Navigation, Guidance, and Control of Intervention AUVs, respectively. Lionel Lapierre and Alex Penas of IST cooperated also actively with David Labbe towards the *development of an integrated computer-based simulator to assess the expected performance of NGC algorithms*. The participation of IST in this endeavour focused on controls. In the course of the work carried out, Lionel Lapierre prepared and submitted 3 papers to international conferences. Some of the papers are currently being reviewed and will be submitted for possible publication in peer reviewed journals.

In the Summer of 2003, IST/ISR organized an expedition to the Azores with the objective of executing tests with an AUV at sea. The Young Researchers Lionel Lapierre and Alex Penas played an actively role in the tests, actually witnessing the different phases of system design, development, and launching of an AUV at sea. During the test, visitors from Italy (Istituto Automazione Navale, Genova), UK (System Technologies), and India (National Institute of Oceanography) were present. This afforded the Young Researchers a unique opportunity not only to get their hands on real experiments but to interact with well established researchers in the fields of marine robotics, underwater communications, and ocean instrumentation. It is felt that the participation of the Young Researchers in the tests was a quantum leap that changed their perception of the area and imparted a solid push to their scientific careers.

Research Areas: Navigation, Guidance, and Control of Marine Vehicles

Laboratories: Dynamical Systems and Ocean Robotics Lab (DSORL)

External Partners: CEA Teleoperation and Robotics Department (F), Democritus University of Thrace (Gr), The Joint Research Centre of the European Commission (I), Instituto Superior Técnico (P), University of Southampton (UK), UKIFREMER (F).

Initiated: October 2000

Conclusion : October 2004.

Classification: Human Potential Research Training Network No. HPRN-CT-2000-00032

Documents produced in 2003: [44] , [47] , [52] , [56] , [57] , [115] , [124] , [125] .



Project name: MAROV – MAPPING OF MARINE HABITATS IN THE AZORES USING ROBOTIC VEHICLES



Project Leader within ISR: Prof. António Pascoal (IST/ISR)

Project Coordinator: Prof. António Pascoal (IST/ISR)

Project Description: This project puts forward the concept of marine habitat mapping using an autonomous surface vehicle (ASV) and an autonomous underwater vehicle (AUV) equipped with acoustic and vision systems. The ASV allows for the mapping of large areas of the seabed (albeit with low resolution) using acoustic sensors. Furthermore, it acts as an interface between the AUV and a support ship. The AUV is used for higher resolution acoustic mapping, ocean data acquisition, and video and photo image taking closer to the seabed. Data obtained by the two vehicles and other complementary “classical” sources (for example, divers or towed systems) will be geo-referenced, analyzed by marine geologists and biologists, and processed to generate composites of benthic ecosystems using a Geographic Information System (GIS). The project brings together marine science and technology and aims at building habitat maps in marine reserve areas around the islands of Pico and Faial in the Azores.

Research Areas: Marine Habitat Mapping Techniques

Laboratories: Dynamical Systems and Ocean Robotics Lab (DSORL), VISLAB

External Partners: IMAR and Department of Oceanography and Fisheries, Univ. Azores, IGM – Geological Survey of Portugal.

Initiated: December 2000

Conclusion : November 2004

Classification: PDCTM, FCT (PT)

Documents produced in 2003: [1] , [44] , [45] , [46] , [56] , [57] , [58] , [59] , [60] , [115] , [116] , [117] , [124] , [127] , [128] , [130] , [131] .



Project name: DREAM – DEVELOPMENT OF A “SEMI-DEEP” ROV FOR SCIENTIFIC APPLICATIONS AND ENVIRONMENTAL MONITORING.

Project Leader within ISR: Prof. António Pascoal (IST/ISR)

Project Coordinator: IMAR / Laboratório da Guia, Cascais, Portugal.

Project Description: The objective of the present project is the development of a **Remotely Operated Vehicle** capable of “semi-deep” intervention (down to the 1000m range) to be used by the Portuguese scientific community in a variety of ocean research missions. Such a vehicle will allow for the investigation of a group of poorly known environments, including the Portuguese continental shelf, where the large majority of national fisheries are deployed, and the upper “levels” of the different canyons that cut into the Portuguese platform and that condition the Portuguese bathial environments to a high extent. “Off the shelf” vehicles can be found, capable of operating down to the proposed depth

range, but none with the type of specifications needed for **environmental observation** and **monitoring**, namely in what relates to accurate positioning and work capacity – sensors and probe installation, sampling gear, video signal processing, etc.

The key technical contribution of the project is the enhancement of a basic ROV structure to enable precise vehicle navigation, guidance, and control as well as acoustic and vision data acquisition, pre-processing, and transmission to a support ship. This will enable maneuvering the ROV along pre-determined searching paths without tight human supervision. Furthermore, it will endow scientific end-users with the capability to survey the ocean floor with great precision by acquiring, among other, side-scan, video, and photo images that are accurately time and position tagged, allowing for mapping of the sea-floor. The user is thus relieved from the tedious and often unsuccessful task of trying to achieve precise vehicle control, namely in the presence of sea currents, effectively shifting the focus of the whole operation to scientific data assessment and overall mission control.

Another objective of the project is the possibility of applying a new concept by developing a “modular” vehicle, capable of being reconfigured for different purposes and mission scenarios. Indeed, no vehicle will meet directly the need of different “configuration” levels, enabling its use from different vessels and at a variety of depth ranges – from “shallow” intervention (c.a. 400m) onboard light vessels of “opportunity” to “deep” diving (down to c.a. 1000m) from a dedicated ship – and a quick “response time” to solicitations such as unpredictable environmental phenomena (e.g. submarine eruptions, spills or other accidents).

The proposing team brings together to the core of the project complementary expertises:

- i) the technical competence to develop such a vehicle from a brand system (ISR-IST);
- ii) the experience of operation of ROV’s in the Portuguese environments (IMAR-LMG, CREMINER);
- and
- iii) the capacity to operate the vehicle at sea under a wide range of different conditions (IH).

This is an important step in the development of collaborative ventures between science and technology, where either of the two components directly depends on the contribution from the other. The concept also opens the possibility of addressing specific needs of end-users, including social concerns, namely relating to natural resources management. Finally, the proposal includes the execution of specific surveys at sea. This will allow for the actual testing and demonstration of the vehicle capacities, both in its original configuration and after project development.

Research Areas: Marine Habitat Mapping Techniques

Laboratories: Dynamical Systems and Ocean Robotics Lab (DSORL), VISLAB

External Partners: IMAR/Laboratório da GUIA, CREMINER, Faculdade de Ciências da Universidade de Lisboa.

Initiated: December 2000

Conclusion : November 2004

Classification: PDCTM, FCT (PT)

Documents produced in 2003: [56] , [116] , [119] .



Project name: MEDIRES

Project leader within ISR: Prof. Carlos Silvestre (ISR / IST)

Project Coordinator: Dr. João Alfredo Santos (LNEC)

Project description: The cost of a rubble-mound breakwater, its expected behaviour, as well as the consequences of its failure, do justify the existence of a monitoring programme which helps in the decision making process relative to the timing of the maintenance, or even repair, works. However, the continuous monitoring of the status of any given breakwater stretch is not yet feasible. That is why the most common procedure consists of the periodic inspection of these structures. The goals of the MEDIRES project are two fold:

- i) To use the latest technological breakthroughs in positioning, navigation, and control of surface autonomous vehicles to develop new techniques for accurate and efficient inspection of the geometry of semi-submerged structures with application to rubble mound breakwaters. This activity will end up with the development of a tool, named IRIS, for high accuracy surveying of both the above water and submerged parts of the armour layer of rubble-mound breakwaters (or semi-submerged structures, in general). This tool that can be used in autonomous mode or equip an Autonomous Surface Craft to produce tri-dimensional surveys with the spatial regularity required for this kind of structures;
- ii) To condense the large volume of data from the periodic inspections into a small set of parameters that enables the characterization of the structure's status and evolution. The definition of the parameters thresholds, needed for the structure's diagnosis, will be based on LNEC's past experience as well as on results from scale model tests.

The tool (IRIS) will be designed to equip the autonomous catamaran DELFIM, property of IST/ISR. Within the framework of this project, accurate path following control and navigation systems will be developed in order to guarantee the repeatability of the maneuvers so as to ensure the quality of the survey data sets obtained. Nevertheless, the IRIS can be used in a standalone mode without the autonomous vehicle.

The autonomous catamaran, named DELFIM, is capable of following pre-assigned trajectories with a high level of accuracy. It is equipped with two back electrical thrusters and can travel at a maximum speed of 5 knots. In order to determine its position and speed it uses differential GPS and an attitude reference unit. Using the information available from its motion sensor suite the catamaran DELFIM computes its actual position and orientation and respective velocities.

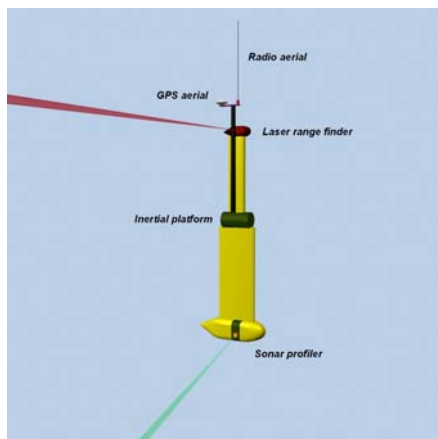

The IRIS tool



Simultaneous above and underwater surveying

A real time computer network developed at the Institute for Systems and Robotics is used in the autonomous vehicle DELFIM. This network was specially designed for multi-vehicle robotic applications, uses wireless modems, and implements TDMA (Time Division Multiple Access). The network will effectively allow an operator to supervise the IRIS tool during the survey. Figure 2 depicts the concept of the Catamaran DELFIM equipped with the IRIS, during a typical breakwater survey. Figure 1 shows how the tool is placed in the Catamaran and also how the 2D laser range finder and the sonar profiler can be used in a breakwater survey mission.

The inspection techniques to be developed within the framework of this project will be tested in Sines' West breakwater and in the breakwater of the Avilés port (in Astúrias, Spain). Several surveys will be conducted during the project, to identify and tune the algorithms and tools for online data set acquisition and off-line processing.

Research Areas: Real Time Architectures, Inertial Navigation, Laser and Acoustic Mapping.

Laboratories: Dynamical Systems and Ocean Robotics Lab (DSORL)

External Partners: Laboratório Nacional de Engenharia Civil, Lisbon, Portugal; Administração do Porto de Sines, Sines Portugal; Autoridade do Porto de Avilez, Avilez, Espanha.

Initiated: March 1 2003

Expected conclusion: February 28 2006

Classification: AdI (Agência de Desenvolvimento e Inovação).

Documents produced in 2003: [1] , [43] , [101] ,[127] .



Project name: MAYASub



Project leader within ISR: Prof. António Pascoal (ISR / IST)

Project Coordinator: Prof. António Pascoal (ISR / IST)

Project description: The key objective of the project is to develop and demonstrate the performance of a small, modular, autonomous underwater vehicle (AUV) for scientific and commercial applications. Envisioned missions include geological and oceanographic surveys, marine biology studies, marine habitat mapping for environmental management, inspection of harbours and estuaries, and marine pollution assessment, to name but a few. Vehicle miniaturization will be achieved by resorting to small embedded processors, miniaturized sensors, and high performance actuators. Modularity will allow for easy vehicle reconfiguration according to different mission scenarios. Reduced weight will make it possible to launch and retrieve the vehicle by resorting to small ships of opportunity. The ultimate goal of the project is the development (by a Portuguese-Indian consortium) of two copies of a highly reliable mobile platform that will act as a natural extension of its support ship, effectively allowing an operator to probe the surrounding 3D environment from the comfort of his/her lab at sea.

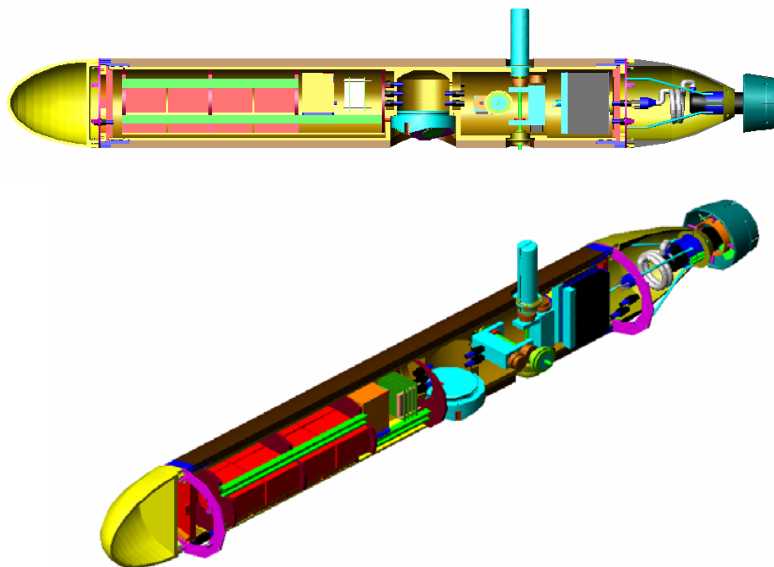

The MAYA AUV - Mechanical Design of the NIO, India

Research Areas: Marine Vehicle Design, Hydrodynamic Parameter Estimation and Identification, Navigation, Guidance, and Control, Acoustic Marine Sensors, Underwater Positioning and Communications.

Laboratories: Dynamical Systems and Ocean Robotics Lab (DSORL), VISLAB

External Partners: RINAVE (PT), IMAR/DOP/Univ. Azores (PT), National Institute of Oceanography (NIO) , Dona Paula, Goa, India, System Technologies (ST), Ulverston, UK.

Initiated: January 2003

Expected conclusion: July 2006.

Classification: AdI (Agência de Desenvolvimento e Inovação).

Documents produced in 2003: [44] , [45] , [46] , [56] , [57] , [115] , [116] , [118] , [124] , [127] , [128] , [130] , [131] .



Project name: SUMARE - SURVEY OF MARINE RESOURCES

Project leader within ISR: Prof. Isabel Lourtie, Prof. José Santos -Victor (IST/ISR)

Project description: The goal of SUMARE is to prove the utility of autonomous sensors for environmental monitoring, showing their efficiency in providing to the competent authorities the data required to guarantee a safe and sustainable exploitation of natural resources. Besides obvious savings in terms of time and costs associated with the use of oceanographic ships, autonomous sensors offer the possibility of :

- (i) adaptively selecting the regions to be sampled in response to observed data;
- (ii) exploiting the morphological characteristics of the sampled field to improve accuracy and consistency.

The project's work program assesses the multi-disciplinary issues underlying these goals: environmental knowledge modelling, data fusion, sensing and guidance. Its results will be tested in two marine applications :

- (i) monitoring of the evolution of sand banks and
- (ii) mapping of living/dead maerl.

The work program of the project is articulated around the main issues contributing to the design, implementation and use of autonomous intelligent sensors for monitoring applications. Use of existing knowledge concerning the macroscopic behaviour and physical constraints of a natural field can considerably increase data gathering efficiency, by enabling, in real-time, to use the measurements already acquired (or those of correlated parameters) to predict the most interesting or informative regions. For each application considered in the project, existing data, physical models and heuristic rules, will be used to identify mathematical prediction and extrapolation models for real-time guidance of the sensors. Moreover, monitoring efficiency is also increased by concentrating resources on optimizing those performance indexes that reflect the actual needs of the post-processing stages of the acquired data. The project will study the problem of translating specific user needs in performance criteria and associated observation strategies, with the following guideline: data does not need to be better than the requirements imposed by its ultimate utilization. To effectively use prior knowledge while optimizing relevant performance criteria, the sensors must have sensing modalities and guidance laws enabling on-line execution of adaptive observation strategies. The project will develop the advanced sensing and guidance techniques required by the two kinds of applications considered.

Two true-size at-sea data acquisition campaigns will be used to evaluate the project's results in terms of facility of deployment, efficiency, accuracy, and cost. These campaigns will be conducted using two underwater platforms already existing in participating laboratories modified to fit their needs. The association to the consortium of a User Group, whose role is to follow its developments will provide critical input in terms of other application domains.

Research Areas: Signal Processing, Navigation, Computer Vision

Laboratories: Signal and Image Processing Lab, Vislab - Computer Vision Lab

External Partners: Management Unit of the North Sea Mathematical Models (B), International Centre for Island Technology - Heriot-Watt University (UK), I3S (Laboratoire d'Informatique, Signaux e Systèmes de Sophia Antipolis - CNRS- Université de Nice Sophia Antipolis) (FR), Thomson Sintra ASM (FR).

Initiated: 2000

Expected conclusion: October 2003

Classification: IST Project , IST-1999-10836

Documents produced in 2003: [86] .

3.1.2 COOPERATIVE ROBOTICS

Project name: SocRob - Society of Cooperative Robots

Project leaders: Prof. Pedro Lima, Prof. Luis Custódio (AIMS Lab)

Project description: This project fosters general research on multi-agent robotic systems, aiming at introducing methodologies for task planning, task allocation and teamwork supervision/coordination, driven by results from Distributed AI, Hybrid Systems and Discrete Event Systems theory. Its current case study is on Soccer Robots, with regular participations in RoboCup. The FCT project started in 2003 includes the construction of new omnidirectional 3-wheeled robots

Research Areas: Cooperative Robotics, Sensor Fusion, Multi-Agent Systems, Teamwork, Discrete Event Systems.

Laboratories: Intelligent Systems Lab

External Partners: IdMind , ServiLog

Initiated: January 1997 , FCT project since October 2003

Expected Conclusion: undefined (FCT Project : March 2005)

Classification: FCT POSI/ROBO/43900/2002

Documents produced in 2003: [13] , [62] , [63] , [64] , [102] , [103] , [104] .



Project name: SACOR - SEMI-AUTONOMOUS COOPERATIVE ROBOTS

Project leader within ISR: Prof. João Sequeira (IST/ISR)

Project description: This projects aims at developing a distributed architecture to control multiple robots cooperatively, executing realistic missions with the help of human specialists. Foreseen practical applications include the assistance to the elderly and handicapped and remote surveillance and maintenance.

This project addresses the following topics:

- (1) Synthesis of motion strategies (actions) using Viability Theory;
- (2) Hybrid representation of the team state, with the discrete part of the state including event information exchanged among robots and specialists, and the continuous part of the state including the actions;
- (3) Properties relevant from the mission execution perspective, namely controllability and stability, in the context of the hybrid systems addressed in topic (2).

Topic (1) discusses the influence of uncertainty in the synthesis of each of the robot's actions by selecting classes of controllers that make a differential inclusion (the action) viable in some pre-assigned set (the set bounding the possible trajectories in the robot's C-space).

Topic (2) addresses the formal aspects of joining the relevant issues in viability theory with those in hybrid systems theory.

Topic (3) addresses the effect of negotiation models in team controllability and stability and on the formation of coalitions.

Research Areas: Cooperation of robotic devices
Laboratories: Mobile Robotics Lab
External Partners:
Initiated: September 2002
Conclusion: September 2005
Classification: POSI/SRI/40999/2001
Documents produced in 2003: [142] , [73] , [74] , [76] .



Project name: RESCUE – Cooperative Navigation for Rescue robots

Project leader: Prof. Pedro Lima

Project description: This project fosters research on multi-agent robotic systems for search and rescue operations as its long-term goal. Currently, the project is focussed on obtaining new results on outdoors perception and navigation, both for individual and cooperative robots.

Research Areas: Distributed Continual Planning, Robotic Task Coordination, Cooperative Navigation, Cooperative Perception, Vision-Based Topological Mapping
Laboratories: Intelligent Systems Lab, Computer Vision Lab, Mobile Robotics Lab
Initiated: November 2000
Expected conclusion: October 2004
Classification: POSI/33293/SRI/2000
Documents produced in 2003: [75] , [77] .



Project name: Formation Estimation Methodologies for Distributed Spacecraft

Project leader: Prof. Pedro Lima

Project description: This project consists of a literature survey followed by the proposal, development and test, in simulation, of an extension of the traditional Guidance, Control and Navigation loop for a single spacecraft to a set of spacecraft flying in formation. This extension creates some novel challenges, since each spacecraft can be considered an obstacle for its team-mates, especially during formation initialisation, relative or absolute information about the formation state can be considered, both state estimation and control can be centralized/distributed or decentralized and do not necessarily need to be tied to the actual topology of the spacecraft formation. A study will be carried out so as to identify different approaches to the state estimation and control of spacecraft formations, as well as to compare them according to different criteria such as fuel consumption, fuel distribution across the spacecraft, robustness to spacecraft failure, communication link failure, individual sensor failure or temporary occlusions of either communications or sensor reading. Decentralized solutions seem to be the most promising approach, as they do not depend on a communications link and/or on a central spacecraft. As such, this work will devote more attention to solutions where both estimation and control can be computed locally at each spacecraft and thus depend solely on relative measurements, feasible at each spacecraft. Nevertheless, centralized/distributed approaches will be covered as well, and issues such as robustness in the presence of temporary occlusion or permanent failure of sensors and communications, as well as the minimization of information flow will arise.

Research Areas: Satellite Formations, Formation Control, Multi-vehicle state estimation, Multi-Agent Coordination Architectures
Laboratories: Intelligent Systems Lab

External Partners: DEIMOS Engenharia (PO)
Initiated: July 2003
Expected Conclusion: August 2004
Classification: ESA (European Space Agency) 17529/03/NL/LvH/bj
Documents produced in 2003: [133] , [134] , [135] .



Project name: RAPOSA - Robot Semi-Autónomo Para Operações de Salvamento

Project leader: IdMind, Engenharia de Sistemas, Lda

Project description: This project aims at building a robot for Search and Rescue (SAR) operations, designed to operate in outdoors hazardous environments, such as debris resulting from structure collapses. At this stage, the robot will be equipped for search operations only, defined as the tele-operated detection of victims, using specific sensors, whose information is transmitted to the remote operator. The robot will be semi-autonomous, i.e., it will be tele-operated from a remote station but will simultaneously display the capacity to carry out short tasks autonomously. The robot will execute commands sent by a team of SAR experts, located in a safe place. During task execution, the robot will relay the information from different sensors to the remote command station, so as to provide the human team with relevant information on its surrounding environment (terrain conditions, temperature, dangerous gases, water or heat sources, either from human victims or not). The robot will be a small size, low weight, robust to collisions, dust and water infiltration vehicle.

Research Areas: Semi-autonomous robots, Search and Rescue

Laboratories: Intelligent Systems Lab

External Partners: *Regimento de Sapadores Bombeiros de Lisboa* (Lisbon Fire Department), Perceptual Robotics Laboratory of University of South Florida, USA

Initiated: March 2003

Expected Conclusion: September 2004

Classification: Agência de Inovação – Consortium Projects

Documents produced in 2003: [136] .

3.1.3 EDUCATIONAL ROBOTICS

Project name: Dig3D

Project leader: Prof. João Paulo Costeira (IST/ISR)

Project description: This project aims the development of an optical three-dimensional scanning system, design to respond to the needs of the mould industry.

Three-dimensional scanning is used for industrial dimensional control and reverse engineering. However, most of the automated systems available (either optical or laser) require too much intervention of a CAD operator during the process of reverse engineering, since they return nonparametric primitives that do not convey topologic information. On the other hand, contact systems require a bigger involvement of human resources during the digitalization stage.

The optical system to be developed will present innovative features that will allow 3D models to include topological information, that will be most useful to the CAD engineer. The system will become a production good of great value to the involved company, since it will lead to the optimization of a significant part of its productive system (industrial design and metrology) wherever it is supported by reverse engineering and automated measuring tasks.

Research Areas: Computer Vision, Computer Graphics

Laboratories: Vislab

External Partners: SET SA, Reverse Eng. SA

Initiated: December 2002
Expected Conclusion: September 2004
Classification: Agência de Inovação – Consortium Projects
Documents produced in 2003:



Project name: VirtualScan - Objectos Reais em Conteúdos Multimédia

Project Leader within ISR: Prof. João Paulo Costeira (IST/ISR)

Project Coordinator: Reverse Eng. S.A. , Portugal

This project aims the development and validation of methodologies designed to automate the generation of appealing three-dimensional graphical contents. These methodologies will be integrated within a single multimedia tool, that will be able to (1) generate 3D models by digitizing real object, (2) optimize their visual appearance, (3) map the registered textures and colors onto the resulting geometric models and (4) generate rendering and manipulation code that can be inserted in standard multimedia software.

The results of this project will be used in the construction of an innovative production good, which will optimize the full process of graphical content design for the Internet, cd-rom and interactive TV. This optimization represents a major improvement of the products and services offered by the Companies in this consortium.

Target-customers for such a tool are mainly companies that develop multimedia contents for e-commerce and virtual catalogs (commercial and cultural), computer-game industry, visual-effects and animation.

This project will promote a future technological and commercial partnership between the Companies. The consortium also intends to give international visibility to this project and to actively search for international partners for future technological and commercial cooperation.

Research Areas: Computer Vision, Computer Graphics

Laboratories: Vislab

External Partners: SET SA, Reverse Eng. SA

Initiated: December 2003

Expected Conclusion: December 2004

Classification: Agência de Inovação – Consortium Projects

Documents produced in 2003:

3.1.4 IMAGE PROCESSING

Project name: TMO - Tracking of Moving Objects with Trained Multi-Models

Project Leader within ISR: Prof. Jorge Salvador Marques

Project description: This project aims at developing robust tracking algorithms for dealing with complex motion and shape dynamics. Current methods achieve good tracking performance in the presence of non-cluttered background and smooth motion and deformation regimes but they typically loose track if one of these conditions fails. This project studies the use of multiple deformable models with switching/mixing algorithms as a way to enlarge the tracking capabilities. This raises several interesting questions: how to combine multiple models or switch between them? Can tracking be improved if the parameters lie on manifold contained in R^n ? What methods can be used to estimate the manifold and the parameter trajectory? Other topics that will be addressed in this project are multi-model learning and robust trajectory estimation methods to reduce the influence of outliers. The proposed algorithms will be tested in selected applications.

Research Areas: Image Processing
Laboratories: Signal Processing Lab.
External Partners: IST, ISEL
Initiated: 1999
Expected conclusion: 2003
Classification: PRAXIS/P/EEI/12050/1998
Documents produced in 2003:



Project name: LTT - Long Term Tracking of Multiple Objects for Surveillance

Project leader: Prof. Jorge S. Marques

Project description: This project aims to develop methods for long term tracking of multiple objects in video sequences. Multiple object tracking has received the attention of the image processing community in the last 5 years, fostered by surveillance applications and by Model Based Video Coding (MPEG).

The first works addressed short-term tracking and recognition of activities. More recent works have tried to address long term tracking of moving objects. This is a more difficult problem since it involves the ability to disambiguate the trajectories of the objects after they were grouped and occluded for some time.

This project aims to address this problem. We wish to detect moving regions in video sequences and to develop algorithms to label each region in a consistent way along the whole video sequence. An additional difficulty concerns the presence of merged regions which can not be identified by a single label. Probabilistic models, namely probabilistic networks, will be adopted to perform this task and to propagate probable labelling scenarios. The tracking algorithms will be applied in the context of urban surveillance.

Research Areas: image processing, surveillance
External Partners: Polytechnic Institute of Lisbon
Initiated: 2002
Conclusion: 2004
Classification: POSI/ CPS / 37844 / 2001
Documents produced in 2003:



Project name: HEART 3D - Measurement of the Heart Geometry from Ultrasound Images

Project Leader within ISR: Prof. Jorge Salvador Marques (IST/ISR)

Project Description: This project studies heart diagnosis tools based on 3D ultrasound techniques. The project has three main goals: i) the development of image reconstruction and heart measurement algorithms for the analysis of the cardiac cycle and computation of clinical parameters (ventricular volume, ejection fraction and wall thickness) ; ii) implementation of an experimental set up for the acquisition of 3D data during medical examinations of the heart and iii) clinical evaluation of the 3D ultrasound algorithms developed in the project Bayesian reconstruction methods will be used to estimate a 3D+T model of the heart at different instants of the cardiac cycle. The region of interest will be described using a multi-scale representation based on 3D splines. The motion and deformation of the heart cavities will be obtained by segmenting the reconstructed volume at each instant of time. To fill the gaps between the inspection planes some kind of interpolation has to be devised. This operation is embodied in the Bayesian reconstruction provided that an adequate prior is used. Unfortunately popular Gaussian priors have an undesirable smoothing effect at the boundaries, which degrades the estimation of the heart walls. Therefore, a discontinuity preserving prior will be used instead. Another key aspect for achieving high quality results concerns the data model used for reconstruction.

Research Areas: medical imaging, image processing, image reconstruction, noise removal
Laboratories: Signal Processing Lab.
External Partners: Cardiology Department of Hospital de Santa Maria, University of Aveiro
Initiated: 2000
Conclusion : 2003
Classification: POSI/33726/CPS/2000
Documents produced in 2003:



Project name: AMA- Automatic Modeling of Architecture

Project leader: Prof. Pedro M. Q. Aguiar

Project description: The goal of this project is to develop a new approach to the fully automatic 3D modelling of architecture from a video sequence.

The recovery of 3D structure (3D shape and 3D motion) from a video sequence has been widely addressed in the recent past by the computer vision community. The strongest cue to estimating the 3D structure from a video clip is the 2D motion of the brightness pattern in the image plane. For this reason, the problem is generally referred to as structure from motion (SFM). Early approaches to SFM processed a single pair of consecutive frames. Two-frame based algorithms are highly sensitive to image noise. More recent research has been oriented towards the use of longer image sequences. The problem of estimating 3D structure from multiple frames has a larger number of unknowns (the 3D shape and the set of 3D positions) but it is more constrained than the two-frame SFM problem because of the rigidity of the scene. The usual approach to multi-frame SFM relies on the matching of a set of feature points along the image sequence. Dense 3D shape estimates usually require hundreds of features that are difficult to track and that lead to a complex correspondence problem. Due to this difficulty, the automatic 3D modelling from video is still an open research problem.

This project attempts to overcome the difficulty outlined above by taking into account the more distinctive characteristic of common buildings - the flatness of their walls. The methods and algorithms to be developed within this project consider particular scenes whose 3D shape is well described by a piecewise planar model. Under this scenario, instead of tracking pointwise features, one can track larger regions where the 2D motion is described by a single set of parameters. The 3D structure of the scene is then computed from the 2D motion parameters. This approach avoids the correspondence problem and is particularly suited to constructing 3D models for buildings and urban scenes that are well described by piecewise flat surfaces.

The proposed project will lead to a method that is simultaneously a powerful tool to "virtualize" buildings and urban scenes and a further step into the development of artificial vision systems. Usually, constructing 3D scene descriptions suitable to virtual manipulation requires a lot of human interaction. The usefulness of the proposed method is due to the fact that it replaces the human interaction by a procedure that recovers 3D models from a video clip in a fully automatic way. That method can also be seen as a further step into the development of artificial vision systems because the piecewise planar assumption is valid as an approximation of the shape of the environment in more general scenarios.

The approach to be followed in this project is then summarized in the following two steps:

Step i) From the video sequence, estimate the set of parameters describing the 2D motion of the image brightness pattern. The 2D displacement between two perspective views of the points that fall into a plane is given by a homography. The first part of the project will be devoted to the development of a new method to robustly estimate homographies from pairs of images.

Step ii) Given the set of parameters describing the 2D motion, compute the 3D shape of the scene and the 3D motion of the camera. The second part of the project concerns solving this large non-linear problem by using linear subspace constraints that proved to be efficient in related problems.

Research Areas: video processing

Laboratories: Signal Processing Lab.

Initiated: 2002

Conclusion: 2005

Classification: POSI/SRI/41561/2001

Documents produced in 2003: [83] , [84] .

3.1.5 UNDERWATER ACOUSTICS

Project name: DETECTION AND FUZZY CLASSIFICATION OF TRANSIENT SIGNALS IN THE TIME - FREQUENCY PLANE

Project Leader: Prof. Victor Barroso (IST/ISR)

Project description: New techniques for passive detection and classification of underwater acoustic transient signals are developed and tested. The focus is on theoretical and algorithmic aspects so as to achieve an acceptable compromise between optimality and robustness to model mismatches, and computational efficiency. Several classes of transients are considered, e.g., man made, mammals' signatures, and spiky noise generated by hydrothermal vents, covering a diversity of frequency bands and physically appropriate source models (deterministic and stochastic). The methods here proposed match the temporal non-stationary of transient signals. Observation noise is assumed either Gaussian or non-Gaussian impulsive.

Data representation involves filtering and sampling the received signal, followed by a linear decomposition using the discrete wavelet transforms with compactly supported short duration filters. Assuming that a delayed signal is correctly represented by its delayed coefficients, the process described is optimized, yielding the best compromise between performance and computational complexity. This implies choosing the observation intervals, the sampling frequencies, the likelihood test rates for real-time processing, and the design of the mother wavelets. Sub optimum processors are also developed for multipath ambient, assuming random multipath attenuations and delays. The proposed approach can increase the robustness of the resulting detector, requiring much less computations than the generalized likelihood ratio test.

Translating classical detection techniques to the Time-Frequency (TF) plane does not produce better detection statistics. However, working in the TF plane provides a significant advantage: more powerful pre and post processing allow operation in lower SNR's (<-5 dB). By adjusting the TF kernel, distinct sub optimal detectors result and the best suited for each specific transient can be selected. Additional complexity, due to bidimensional correlation, is combated using a generalized distribution, representing the transient as a delta distribution. This square root the computational cost. The design of that distribution, being trivial for polynomial phase signals, is generalized to accommodate the transients considered.

The performance of the proposed techniques is evaluated based on the theoretical analysis of the algorithms developed and/or on computer experiments driven by simulated and real data.

Research Areas: Statistical Signal Processing

Laboratories: Signal Processing

External Partners: Escola Naval (Portuguese Navy School)

Initiated: 2000

Conclusion: April 2004

Classification: POSI/32708/CPS/2000

Documents produced in 2003: [85] .

Project name: Acoustic Tomography Monitoring System - ATOMS

Project leader within ISR: Prof. Sérgio M. Jesus

Project Coordinator: Prof. Sérgio M. Jesus

Project description: The ATOMS project aims at developing an integrated system for large-scale ocean monitoring, using acoustic tomography. In order to demonstrate the feasibility of the approach, an experimental test will be performed to characterize the upwelling filament structure off the Cape São Vicente.

Objectives

1- To study the feasibility of a tomographic acoustic network to monitor the entire Portuguese EEZ. That network will be composed of 4/5 acoustic emitters/receivers located in the Azores, continental Portugal and Goringe bank and/or Madeira island. The modeled network will use archived data of temperature/salinity profiles (from NODC and BODC data bases). The main characteristics of the network will be determined in order to achieve a given performance in terms of temperature and current resolution.

2 - To develop an integrated system for Ocean Acoustic Tomography (OAT) and perform a test at sea.

3 - To develop a preliminary application of the integrated system to monitor a particular area off the Portuguese EEZ. The test target will be the Cape São Vicente filament area, which is one of the most developed and recurrent filaments observed and has important implications in the biological and chemical exchanges between the coastal and offshore ocean.

Research Areas: ocean acoustic tomography , environmental monitoring

Laboratories: SiPLAB

External Partners: CINTAL, EST (UALG), CIMA, IH

Initiated: October 2000

Expected conclusion: September 2004

Classification:

Documents produced in 2003: [21] , [22] , [23] , [69] , [70] , [137] , [138] .



Project name: Source Localization with a Random Field of Sonobouys in shallow water - LOCAPASS

Project leader within ISR: Prof. Sérgio M. Jesus

Project Coordinator: Prof. Sérgio M. Jesus

Project description: The LOCAPASS project aims at developing an integrated system for passive source localization using a single or a small number of acoustic sensors. The principle is based on using the environmental information as modeled by an acoustic propagation model to discriminate a perturbation introduced by an active source. Previous results have shown that: i) if the sound source has a relatively large time-bandwidth product and ii) the environment is sufficiently known and stable, it is indeed possible to obtain single sensor source localization in range and depth. Actual improvements on the receiving system to provide some horizontal aperture and provide rough bearing estimation as well.

Objectives

1- To study the feasibility of a single sensor source localization system.

2 - To develop a real system based on sonobouys.

3 - To experimentally test the developed system prototype at sea.

Research Areas: underwater signal processing and communications

Laboratories: SiPLAB

External Partners: CINTAL, IH
Initiated: July 2001
Expected conclusion: July 2003
Classification:
Documents produced in 2003: [139] .



Project name: Tomografia Passiva Costeira - TOMPACO

Project leader within ISR: Prof. Sérgio M. Jesus

Project Coordinator: Prof. Sérgio M. Jesus

Project description : The main objective of this project is to develop a new method for underwater acoustic tomography that uses as source signal the noise emitted by ships of opportunity, received on vertical arrays distributed along the coast, with the objective of measuring the water temperature and currents of oceanographic interest.

Research Areas: ocean acoustic tomography
Laboratories: SiPLAB
External Partners: DUNE (Italy), OGS (Italy), ENEA (Italy)
Initiated: May 1999
Expected conclusion: March 2003
Classification:
Documents produced in 2003: [71] , [140] .

3.1.6 COMPUTER VISION

Project name: MIRROR – Mirror Neurons for Recognition

Project leader within ISR: Prof. José Santos –Victor (IST/ISR)

Project description: The goals of MIRROR are:

- 1) to realize an artificial system that learns to communicate with humans by means of body gestures and
- 2) to study the mechanisms used by the brain to learn and represent gestures.

The biological base is the existence in primates's premotor cortex of a motor resonant system, called mirror neurons, activated both during execution of goal directed actions and during observation of similar actions performed by others. This unified representation may sub serve the learning of goal directed actions during development and the recognition of motor acts, when visually perceived. In MIRROR we investigate this ontogenetic pathway in two ways:

- 1) by realizing a system that learns to move AND to understand movements on the basis of the visually perceived motion and the associated motor commands and
- 2) by correlated electrophysiological experiments.

Research Areas: Computer Vision
Laboratories: Vislab - Computer Vision Lab
External Partners: DIST - University of Genova (I), University of Ferrara (I), Dept. of Psychology Univ. of Umea, (SE)
Initiated: September 2001

Expected conclusion: September 2004
Classification: EU - FET - 2000-28159
Documents produced in 2003:



Project name: CAVIAR - Context Aware Vision using Image-based Active Recognition

Project leader within ISR: Prof. José Santos -Victor (IST/ISR)

Project description: The main objective is to develop the theory of context-aware visual recognition systems. We will implement the theory in a complete closed-loop vision system, and apply it to two applications (city street surveillance and customer behaviour analysis). To achieve these objectives, we will develop new feature grouping, attention and appearance-based recognition processes. This will also require development of new techniques for acquiring, representing and using visual context and situation knowledge.

Research Areas: Computer Vision
Laboratories: Vislab - Computer Vision Lab
External Partners: University of Edimburgh (UK), INRIA (F)
Initiated: October 2002
Expected conclusion: September 2005
Classification: IST-2001-37540
Documents produced in 2003:



Project name: OMNISYS - Omnidirectional Vision for Navigation and Control

Project leader within ISR: Prof. José Santos -Victor (IST/ISR)

Project description: The main objectives of this project are the study of problems related to robot perception and control using catadioptric systems. In particular visual servoing will include the use of uncalibrated images. The catadioptric systems that will be considered are central projection systems. The goals will include the development of mathematical models and coordinate systems that can simplify instances of servoing. The definition of features that can be robustly tracked with this type of images is also a goal of the project as well as the development of algorithms for servoing using partially calibrated or uncalibrated images. To reach this goal a systematic approach will be used. For that purpose a general mathematical model for perspective/catadioptric imaging formation will be established, covering the situations of vision system motion and the relative motions between the mirror and the imaging device that do not violate the central projection constraint.

Research Areas: Computer Vision, Mobile Robotics
Laboratories: VisLab - Computer Vision Lab
External Partners: ISR - Coimbra Pole
Initiated: September 2002
Expected conclusion: August 2005
Classification:
Documents produced in 2003:

Project name: 3D MODELING FROM VIDEO

Project leader within ISR: João Paulo Salgado Arriscado Costeira

Project description: This project proposes to develop a methodology for video coding by using intermediate 3D representations. The coded video includes a representation of the scene's 3D shape and texture, producing as output a sequence of synthetic views of the scene (which could be different from the original ones). This opens new perspectives to go one step forward towards general content-based video representations. There are three main issues involved which we propose to tackle:

- 1 - Image to image matching,
- 2 - Image to model matching and
- 3 - 3D model building and generation of images from the 3D model.

The main idea is to create a feedback loop of "a priori" knowledge provided by the existent 3D scene model into the matching process, in a global way. By formalizing image to image and image to model matching as an integer programming problem which is then relaxed to a concave programming problem (see [5]), authors believe the whole process of matching and 3D reconstruction can be integrated into a single recursive framework.

Research Areas: 3D reconstruction, Video Coding, Structure from motion, Computer vision

Laboratories: Vislab - Computer Vision Lab, Signal and Image Processing Lab.

Initiated: October 2000

Expected conclusion: 2003

Classification: POSI/34121/SRI/2000

Documents produced in 2003:

3.1.7 ARTIFICIAL INTELLIGENCE

Project name: MS-AGENCY: Control of Manufacturing Systems using Societies of Evolutive Agents

Project leader: Prof. Luis Custódio (IST/ISR)

Project description: In this project, the problems raised by the development, utilization and implementation of both hierarchical and heterarchical control architectures for manufacturing systems (MS) are studied and identified. The goal is to develop a hybrid control architecture where the lower levels are implemented through a heterarchical structure, using a new paradigm of distributed (knowledge) representation called "Societies of Agents". The upper levels are structured into a hierarchy where the top levels provide orders for bottom levels, as usual. In terms of equipment and layout it is assumed that the shop floor is (physical or virtually) divided into a set of manufacturing cells, each one capable of producing a predefined set of products. A single agent represents each cell, which is capable of interacting within a society of similar agents.

Research Areas: Artificial Intelligence, Multi-agent Systems, Manufacturing Systems Control

Laboratories: Intelligence Systems Lab

External Partners:

Initiated: August 2001

Expected conclusion: May 2004

Classification: FCT POSI/P/EEI/12175/1998

Documents produced in 2003:

Project name: DARE – Development of Emotion-based Robotic Agents

Project leader: Prof. Luis Custódio (IST/ISR)

Project description: The aim of this project is the study and development of methodologies and tools necessary to implement emotional robotics agents capable of dealing with unstructured and dynamic environments. Therefore, the goal is not the optimization of some particular ability, but instead the research focus is put on general competence to learn, adapt itself and survive. In order to practically test these ideas, a small autonomous robot will be adapted and used based on technology already developed and tested.

Research Areas: Artificial Intelligence, Emotion-based Agents

Laboratories: Intelligent Systems Lab

External Partners:

Initiated: August 2001

Expected conclusion: May 2004

Classification: FCT POSI/P/EEI/12184/1998

Documents produced in 2003: [17] , [18] , [19] , [20] .

3.1.8 COMUNICATIONS

Project name: SEPARATION OF DIGITAL SOURCES' MIXTURES BY CONVEX METHODS

Project leader: Prof. João Senteiro

Project description: The main objective is to design a spatial division multiple access (SDMA) receiver, which permits to blindly resolve a convolute mixture of digital sources. An existing convex geometrical framework for binary sources is to be extended in order to incorporate in the receiver the following features:

- (a) robustness to the channel order detection step. By (possibly) avoiding the estimation of the orders of the space-time channels activated by the sources, the receiver will outperform (in terms of robustness) most of the current approaches, whose performance is known to depend crucially on the accuracy of these estimates - specially for band limited channels whose impulse response exhibits smooth roll offs making the channel length ill-defined. To meet this requirement, the linear equalizers have to be characterized directly in the observation space, which poses new theoretical challenges;
- (b) ability to cope with more generic digital modulation alphabets, e.g., PAM,QAM,PSK, etc;
- (c) increased robustness with respect to the noise power, which implies the formulation of new convex (or quasi-convex) problems in the "least-squares" sense.

Research areas: Mobile Wireless Communications

Laboratories: Signal Processing Lab, Theory Group

External partners:

Initiated: October 2000

Expected conclusion: October 2004

Classification: POSI/32948/CPS/2000

Documents produced in 2003:

Project name: CHANNEL ESTIMATION FOR EQUALIZATION AND SYNCHRONIZATION IN OFDM UNDERWATER ACOUSTIC COMMUNICATION SYSTEMS

Project Leader: Prof. Victor Barroso (IST/ISR)

Project description: Digital communication using acoustic modems is the method of choice for exchanging data among distant or highly mobile equipment used in various underwater activities. However, achieving efficient communication in this environment is challenging due to severe distortions that affect the transmitted signals as they undergo multiple reflections and refractions in their propagation path. Attempts to overcome these impairments in high data rate coherent modems haven't been entirely satisfactory, thus hampering their widespread adoption.

Recently, much attention has been devoted to the use of OFDM (Orthogonal Frequency Division Multiplexing) modulation for wireless and cable applications as a way of approaching channel capacity with simple transmitter/receiver architectures. In OFDM the message stream is divided into many parallel lower rate streams that modulate a set of partially overlapping orthogonal carriers. Since longer symbols are less sensitive to multipath, equalization requirements may be considerably relaxed on each sub carrier. This feature is quite appealing in underwater communications, where highly complex filters used for equalization constitute the main computational bottleneck.

Although preliminary studies on the use of OFDM for underwater coherent communication have been published, the analyses are rather superficial and should mainly be regarded as proof of concept. The present proposal will address issues that are particularly relevant in an underwater environment:

1- Channel identification and equalization are extremely important in underwater communication because multipath propagation may induce channel responses lasting hundreds of milliseconds. Unlike terrestrial OFDM applications, frequency-selective channels have to be explicitly considered. Recently developed blind or semi-blind identification techniques should be applicable under such conditions, thus reducing the need for pilot tones.

2- Significant Doppler shift may be induced in acoustic waveforms even by relatively slow emitter/transmitter motion caused by waves and currents. Performance studies for terrestrial OFDM have shown that accurate tracking of average Doppler is required to ensure low intercarrier interference. Average and differential Doppler compensation has not been studied in detail for single-carrier communications, but it will likely play an important role in underwater OFDM systems. An approach based on simple ray propagation models will be used to predict the evolution of Doppler in each path and guide the tracking algorithms.

Research Areas: Statistical Signal Processing

Laboratories: Signal Processing

External Partners:

Initiated: 2000

Conclusion: April 2004

Classification: POSI/33205/CPS/2000

Documents produced in 2003: [91] , [111] .



Project name: MODEM PARA COMUNICAÇÃO DE DADOS VIA CANAL ACÚSTICO SUBMARINO

Project Leader: Prof. Victor Barroso (IST/ISR)

Project description: Desenvolvimento de um protótipo de um modem para comunicações acústicas submarinas. Além do projecto de equipamento ao nível de hardware (electrónica, encapsulamento e integração de transdutores acústicos), existe também uma forte componente de software que visa a implementação e teste de algoritmos de processamento de sinal que permitam compensar as fortes distorções que afectam a propagação de sinais acústicos em ambiente

submarino.

Research Areas: Digital Signal Processing, Communications

Laboratories: Signal Processing

External Partners:

Initiated: May 2001

Conclusion: April 2004

Classification: Ministério da Defesa – Fundação das Universidades Portuguesas

Documents produced in 2003:



Project name: GEODIF - DIFFERENTIAL GEOMETRY BASED SIGNAL PROCESSING TECHNIQUES FOR THE RESOLUTION OF CONVOLUTIVE MIXTURES IN WIRELESS COMMUNICATIONS SYSTEMS

Project Leader: Prof. Victor Barroso (IST/ISR)

Project description: The spatial division multiple access (SDMA) concept for mobile radio cellular systems has recently attracted much attention. SDMA is a spectral bandwidth – saving multiple access technique which provides increased cellular capacity via effective exploitation of the spatial dimension of the radio resource. In SDMA – based wireless networks, several users within the same cell share the same time – frequency channel, as opposed to the other popular multiple access methodologies, e.g., time division multiple access (TDMA) or frequency division multiple access (FDMA), where each channel is occupied at most by one user at a time. This efficient spectral allocation strategy per cell permits to expand the overall capacity of current cellular infrastructures, without consuming additional radio frequency (RF) bandwidth. From the receiver viewpoint, the SDMA technique raises a new signal processing problem: in addition to suppression of the intersymbol interference (ISI) induced by multipath propagation, the SDMA receiver has to separate the linearly superimposed users. Current research on SDMA architectures focus on developing algorithms capable of resolving linear convolutive mixtures of digital sources. The main goal of this proposal is the optimal design of SDMA receivers based on differential-geometric tools. Here, optimality results from the full exploitation of the data model, with possible incorporation of prior knowledge (Bayesian processing).

In fact, spatial and/or temporal over sampling is the preferred data acquisition scheme in SDMA receivers, and leads to highly structured baseband data matrices. In general, these can be written as the product of a block Hankel channel matrix and a block Toeplitz signal matrix, embedded in (usually Gaussian) additive noise. Also, the entries of the signal matrix are restricted to a finite alphabet, dictated by the chosen linear digital modulation format. In the majority of current approaches, this information is only partially exploited so that they are sub optimal in that respect. Moreover, by exploiting 2nd order statistic, further structure can be incorporated into the problem, as the channel matrix can be turned unitary. In this proposal, we aim at designing maximum-likelihood (ML) estimators of the mixing channel matrix and/or of the emitted data sequences, which respect all the known algebraic restrictions. By fully matching the estimators to the data model constraints, a significant improvement of their performance can be expected. The constrained ML estimators are to be derived in a differential geometry framework. This viewpoint has recently proven to be successful in solving some other relevant signal processing problems, e.g., direction-of-arrival (DOA) estimation, denoising of corrupted Hankel matrices, and adaptive subspace tracking. For the structured ML estimation problem at hand, manifold theory seems to be the most natural setting, as the algebraic restrictions on the parameters can be efficiently expressed as Cartesian products of certain differentiable manifolds (Lie groups orthogonal matrices, linear varieties of Hankel matrices, etc.). Optimization of the constrained likelihood function is to be achieved by developing techniques of optimization over differentiable manifolds. This implies a detailed characterization of the constraint differentiable surfaces (tangent spaces, curvature, etc.), which also provides the appropriate tools to study the convergence properties of the class of algorithms to be derived .

Research Areas: Statistical Signal Processing, Communications

Laboratories: Signal Processing

External Partners:

Initiated: January 2002

Conclusion: December 2004

Classification: POSI/38775/CPS/2001
Documents produced in 2003: [87] , [88] .

3.1.9 AERONAUTICS

Project name: VELA - Very Efficient Large Aircraft

Project leader within ISR: Prof. Luis Braga Campos

Project leader: EADS - Germany

Project description: : Role of IST: Assessments of the stability of flying wing aircraft .

Research Areas: Aircraft design, airplane

Laboratories: Aeronautics Group

External Partners: 20 partners

Initiated: 2002

Expected conclusion: 2004

Classification: EU - Industrial Research

Documents produced in 2003:



Project name: ROSAS - Research on Silent Aircraft Concepts

Project leader within ISR: Prof. Luis Braga Campos

Project leader: EADS - Germany

Project description: Role of IST: Modelling of the effect of the wing in shielding the noise from the engines.

Research Areas: Acoustics, Engine noise, Diffractions

Laboratories: Aeronautics Group

External Partners: 18 partners

Initiated: 2002

Expected conclusion: 2004

Classification: EU - Industrial Research

Documents produced in 2003:



Project name: SILENCER - Significantly Lower Community Exposure to Noise (Reduction)

Project leader within ISR: Prof. Luis Braga Campos

Project leader: SNECMA

Project description: Role of IST: Optimization of non-uniform circumferential and longitudinal impedance distribution in engine ducts.

Research Areas: Acoustics, Engine noise
Laboratories: Aeronautics Group
External Partners: 90 partners
Initiated: 2002
Expected conclusion: 2005
Classification: EU - Industrial Research
Documents produced in 2003:



Project name: ENABLE - Environmental Noise Associated with Turbulent Boundary layer Excitation

Project leader within ISR: Prof. Luis Braga Campos

Project leader: Dassault

Project description: Role of IST: Prediction of sound generation by turbulence in a boundary layer and of the correlation of the acoustic pressure induced on the fuselage of an aircraft.

Research Areas: Aeroacoustics, Aircraft design
Laboratories: Aeronautics Group
External Partners: 16 partners
Initiated: 2001
Expected conclusion: 2003
Classification: EU - Industrial Research
Documents produced in 2003:



Project name: JEAN - Jet Exhanot Aerodynamics & Noise

Project leader: Trinity College Dublin

Project description: Role of IST: Research on the relation between the spectrum of turbulence and the spectrum of noise it radiates and on the transmission of sound in a shear layer

Research Areas: Acoustics, Aerodynamics, turbulence
Laboratories: Aeronautics Group
External Partners: 10 partners
Initiated: 2001
Expected conclusion: 2005
Classification: EU - Industrial Research
Documents produced in 2003:

Project name: X-Noise – Aircraft External Noise Network

Project leader: Prof. Luis Braga Campos

Project description: Research on all aspects of Aircraft external noise.

Research Areas: Aeroacoustics, Aircraft Noise

Laboratories: Aeronautics Group

External Partners: 30 partners

Initiated: 2002

Expected conclusion: 2004

Classification: EU – Industrial Research

Documents produced in 2003:



Project name: NEFA – New Empenage for Aircraft

Project leader within ISR: Prof. Luis Braga Campos

Project leader: Airbus France

Project description: role of IST: assessment of coupling of longitudinal and lateral stability.

Research Areas: Aeroacoustics, Aircraft Noise

Laboratories: Aeronautics Group

External Partners: 30 partners

Initiated: 2002

Expected conclusion: 2004

Classification: EU – 5th Framework Programme

Documents produced in 2003:

3.1.10 UNMANNED AIR VEHICLES

Project name: ALTICOPTER

Project leader within ISR: Prof. Carlos Silvestre (ISR / IST)

Project Coordinator: Prof. Carlos Silvestre (ISR / IST)

Project description: Today, some Unmanned Air Vehicles (UAVs) exhibit a high degree of reliability in operation in the presence of dynamic and uncertain environments and challenging operating scenarios. Among the many UAV configurations available today, helicopters are one of the most maneuverable and versatile platforms. They can takeoff and land without a runway and can hover in place. These capabilities have brought about the use of unmanned helicopters as highly maneuverable sensing platforms, allowing for the access to remote and confined locations without placing human lives at risk. For these reasons, there is currently great interest in using unmanned robotic helicopters in a wide range of applications that include crop spraying, hazardous spill inspection, fire surveillance, pollution monitoring, overhead power cables inspection, bridge and building construction inspection, etc.

The major stumbling blocks that have prevented UAVs from executing successfully the aforementioned missions are: i) the unavailability of reliable on-board navigation systems capable of integrating the information from sophisticated

sensor suites; ii) the absence of efficient and easy to program mission control systems; iii) the lack of simple and effective controllers for precise 3-D trajectory tracking and path following.

The main thrust of the project is the development of an unmanned robotic helicopter that can serve as an advanced platform for system design, development, and testing. The project will use an industrial radio controlled helicopter that will be equipped with a distributed real time computing network, a reliable wireless communication system, and sensing devices. To give the work greater focus, the research and development effort will be aimed at performing realistic missions that consist of accurate monitoring of beaches and dunes using airborne laser altimetry. The nature of the envisioned missions will require the use of a 3-D perception system onboard the helicopter. This system will include a highly accurate GPS, a Laser Range Finder, and a Digital Camera. The resulting platform will have the potential for being used in a variety of applications, and will provide subject matter for further research and development.

Underlying the development of unmanned helicopters are their on-board real time navigation, flight control, and mission control systems. These systems will stabilize the platform and implement the different vehicle operation modes. Research will also focus on the development of sensor based control strategies for critical flight conditions, such as automatic landing. Furthermore, to improve the accuracy of the airborne laser altimetry, special emphasis will be placed on developing 3-D path following and trajectory tracking controllers.



The X-treme model helicopter of the DSORL

Research Areas: Nonlinear dynamic modeling, Guidance and Control, Inertial Navigation, laser and vision mapping.

Laboratories: DSOR, VISLAB

External Partners: Instituto Geológico e Mineiro, Lisbon, Portugal

Initiated: May 1, 2002

Expected conclusion: April 30, 2005

Classification: FCT - Sapiens

Documents produced in 2003: [49] , [51] , [53] , [54] , [120] , [121] , [126] , [129] , [132] .

3.1.11 NON-LINEAR CONTROL

Project name: High Resolution Optical Satellite Sensors

Project leader within ISR: Prof. Pedro Lima (ISR / IST)

Project Coordinator: Alenia Spazio (Italy)

Project description: The main objective of this project is to develop a High Resolution Optical Satellite Sensor by using the synthetic aperture technique. This technique consists in the reconstruction of the original image of an object starting from that formed on the common focal plane of a set of telescopes (or a multi-aperture telescope) observing

simultaneously the object while maintaining constant within a fraction of wavelengths the phase of the various wavefronts which are combined together (namely, a set of telescopes correctly co-phased, which, in this case, operate like an interferometer). The synthetic aperture technique thus allow to obtain the same resolution of a monolithic-mirror by means of a set of smaller mirrors properly arranged over the surface covered by the monolithic one, with a dramatic reduction of the volume and the mass of the optics. ISR participation will cover the control of the mirror positions.

Research Areas: Satellites Formations, Non-linear control

Laboratories: Intelligent Systems Lab

External Partners: INETI (Portugal), CSL (Belgium)

Initiated: November 2003

Expected Conclusion: May 2005

Classification: EUCLID - RTP 9.09

Documents produced in 2003:

3.2 POST-DOCS ACTIVITIES REPORTS

3.2.1 Activity report of SEBASTIEN BAUSSON

Period : July 2002 to January 2004

Fellowship : SFRH/BPD/6017/2001

After getting along with the Signal Processing Laboratory members and facilities, Professor Barroso and myself started a new project aiming at strengthening classic statistical estimation theory capabilities for small sample scenarios. A second project dealing with Empirical Mode Decomposition in one and two dimensions was launched in summer 2003 with the collaboration of P. Borgnat and P. Gonçalves.

Strengthening classic statistical estimation theory capabilities for small sample scenarios

Nowadays progress in data acquisition and storage conjugated to the evolution of technologic applications give rise to diverse scenarios where unknown characteristics of the data may imply a failure of classic estimation theory techniques. These last years have thus seen the development of many robust estimation techniques, for instance developed to deal with non-Gaussian random variables. Our work line was chosen as to dig into robust estimation theory, particularly toward techniques usable to temporary or transient data. These data arise for instance from array processing models describing the stochastic signature of a moving target or of a changing environment.

A quite general simplification is to assume that recorded signals are realizations of zero-mean Gaussian independent and temporally white random variables, which naturally leads to deal with the second-order form, or covariance form, of a particular model. In this case, our innovation is to take into account the signals cross-terms, a transient object which goes asymptotically to zero, in the formulation of a traditional robust estimator.

First results obtained shown that the under-determined inverse problem have a multiplicity of solutions, which might be classified in a tracking scenario. This is a drawback as our goal was to work in a small sample scenario. Lengthy optimization procedures were experimented without tangible success, as related in a conference publication and in an internal report accessible online:

S. Bausson and V. Barroso. "Estimation of a rank-one signal subspace in Gaussian small sample regime" IV Conferencia em Telecomunicações, CONFTELE 2003, Aveiro, Portugal, June 2003.

S. Bausson and V. Barroso. "Estimation of a rank-one signal subspace in Gaussian small sample regime" Internal report, November 2003. <https://omni.isr.ist.utl.pt/~bausson/NSOAK.ps>

Empirical Mode Decomposition in one and two dimensions

E. Huang et al. have introduced for nonstationary signals a new adaptive local decomposition technique, referred to as Empirical Mode Decomposition (EMD). It proceeds by iteratively identify AM-FM components with zero mean and a symmetric envelope, thus separating a "fast" contribution from a "slow" one. EMD is based on a very appealing intuitive principle but lacks an analytical definition, thus making not easy the analysis of its performance and limitations.

For instance the algorithm, free of use at <http://perso.ens-lyon.fr/patrick.flandrin/emd.html>, contains a number of degrees of freedom (type of the interpolations, minimization of border effects, stopping criteria), which are left to the user.

Aiming at applying the algorithm upon the time-frequency plane, in order to separate additive components from cross-terms, we are working on the extension of EMD to two dimensions. We found out that the algorithmic extension is not direct because of the decomposition sensibility to the type of two dimensional envelope used. A report considering the influence on the convergence of both the definition of the extremum and the stopping criteria will be available soon.

Lisboa, January 2004
Sebastian Bausson, Ph.D.
Instituto de Sistemas e Robótica
Instituto Superior Técnico

3.2.2 Activity report of PIERRE BORGNAT

Period : September 2003 to August 2004

Fellowship : Inria International Relations: project 13001

Statistical Modeling of Image Symmetries and Stationarization.

This work deals with 2D statistical fields, for instance images but also other random fields coming from other domains (e.g., in physics, the turbulent velocity fields, or a representation of a 1D signal on a time-frequency plane). Knowing how to define the symmetries of one image is a classical way to describe textures (leaving out the study of shapes for now).

Among the interesting symmetries, the scale invariance property has a special relevance both for images (to deal with multi-scale structures) and physical fields. The first part of this work was to define what are possible choices of symmetries for images, especially in the case of scale invariance (or self-similarity for random fields). Using preliminar works on plane transformations, we have studied how one can use a stationarization of those invariances to prescribe the statistical properties of the random fields. Stationarization is a method that study a signal or field that has some invariance by means of a stationary generator. Namely, one tries to find a stationary generator $Y(t)$ that can be warped by some tranform $t=f(u)$ in the original field $X(u)= Y(f(u))$ which has a different invariance. This method was introduced in geostatistics and used in some problems of imaging. We develop this approach for self-similarity of images.

A first point was to describe possible warping functions and the kinds of self-similarity that can be achieved this way. The correlation structure is then controled by the invariance. We have studied how using the stationary generator (and thus means to synthesize this field Y using this stationarity

-- spectral or parametric methods) induces an efficient method of synthesis of self-similar random fields.

A second point is the question of analysis: is it possible to recover the stationarizing warping from one realization of the random field ? Drawing on the method proposed by Perrin and Senoussi (1999) based on the variogram, and on the work of Clerc and Mallat (2000) on wavelet decompositions, we address the problem of scale invariant fields. Preliminary results show that it is possible in this case to recover the warping but a more robust method should be designed. An insight would be to adapt results about local stationnarity (work of F. Garcia and I. Lourtie at the ISR) to cross-check the stationnarity of the unwarped process locally, during the estimation of the inverse warping.

This work was presented in a workshop at the INRIA Rocquencourt in december 20003 [Bor03b].

Sparse Continuous Wavelet Transform Inversion

We have just begun a work on the practical methods to compute inversion of a Continuous Wavelet Transform (CWT) representation. We focus on the methods to recover the signal form a sparse set of coefficients (for example by taking some extrema or ridges).

The objectives are:

- 1) Use those inversions to prescribe statistical properties of a sparse set of coefficients in order to do a correct synthesis of processes (for example the multifractallity intersting for turbulence modeling or network traffic signals). A difficulty when using CWT is that the Hilbert reproducing-kernel structure that has to be preserved ; but we try to solve this problem by using fewer coefficients, without resorting to Discrete WT that implies troubles to obey stationnarity in time (or stationarity of the increments) because of the dyadic tree structure.
- 2) If one can work on the CWT without disturbing its mathematical structure, we hope to improve controled methods of denoising (for example by shrinkage of the relevant wavelet coefficients).

Lisboa, January 2004
Pierre Borgnat, Ph.D.
Instituto de Sistemas e Robótica
Instituto Superior Técnico

3.2.3 Activity report of ETIENNE GROSSMANN

Period : January 2003 to November 2003

Fellowship : Project CAVIAR - 0441

Dr. Etienne Grossmann worked as a postdoc during 2003 integrated in the EU project CAVIAR. The aim of the project is the development of context based aware vision systems, particularly for the application of video surveillance.

As more and more cameras are being used for surveillance, it becomes unrealistic to have human operators looking at these numerous video streams to detect events deserving detailed attention. Instead, it is important to develop systems able to manage this vast amount of information and really *understand* the scene and *interpret* the observed actions.

The work developed follows two main lines. On one hand we are looking at attention mechanisms studied in human perception to develop algorithms able to direct the system's attention towards the most promising areas of the scene or cameras. Secondly, we are interpreting the tracked trajectories over long time intervals to learn directly from the data events like *walking, running, leaving objects behind, etc.* Once such events have been detected, they will allow for customizing the performance of the whole system, in such a way that operation is modulated by the detected contexts in the scene.

Lisboa, November 2003
Etienne Grossmann, Ph.D.
Instituto de Sistemas e Robótica
Instituto Superior Técnico

3.2.4 Activity report of NUNO GRACIAS

Period : July 2003 to December 2003

Fellowship : Project MIRROR - C535

After defending his thesis in June 2003, Dr. Gracias remained as a postdoc until December 2003, working for the EU Project MIRROR. During this time, Dr. Gracias prepared some of the algorithms developed for his thesis to be used by other group members. He additionally co-supervised some undergraduate students working in the problem of vision-based control of an aerial blimp. This work consisted in using video mosaics of the ground (aerial photos) to define trajectories to follow by this aerial blimp and to develop a closed-loop vision system to follow these trajectories.

In the context of Mirror, Dr. Gracias provided support in developing tools for visual motion estimation. One of the objectives of Mirror consists in performing sensorimotor coordination with a robotic system equipped with an arm, hand and binocular vision. For that purpose, it is important to perform segmentation of the moving hand or scene objects to be able to control the actions of the robot or recognize the actions performed by others. Dr. Gracias also prepared a paper on an extension of his thesis work that was submitted (and accepted) the FAC Symposium on Intelligent Vehicles, 2004.

Lisboa, November 2003
Nuno Gracias, Ph.D.
Instituto de Sistemas e Robótica
Instituto Superior Técnico

3.2.5 Activity report of ETTORE BARROS

Period : 2003

My post-doctoral research work at the DSORL is funded by CAPES of Brasil, during my leave from the University of São Paulo, where I am a member of the teaching staff of the Department of Mechatronics. The work carried out during 2003 focused on AUV Modeling and Parameter Estimation and is briefly summarized below

Research Topic:

MODELING, PARAMETER ESTIMATION, AND COMBINED PLANT-CONTROLLER OPTIMIZATION OF AUTONOMOUS UNDERWATER VEHICLES (AUVs)

Objective :

My work program at DSORL addresses the general problem of autonomous *underwater vehicle (AUV) modeling and parameter estimation* as a means to predict the expected dynamic performance of AUVs and thus guide their design phase well before they can be tested at sea. This will shorten the time of vehicle design and development and reduce drastically the costs associated with intensive hydrodynamic tank tests.

Methods for parameter estimation based on the geometry of a marine vehicle and its mass distribution properties have been used for decades in the ship building industry. Important steps have also been taken in order to adapt parameter estimation methods, originated in the aeronautical science, to the prediction of submarine and AUV dynamics [1]. Recently, spawned by the widespread availability of powerful computers, there has been a surge of interest in applying Computational Fluid Dynamics (CFD) methods to the prediction of stability derivatives for marine vehicles [2]. However, to the best of my knowledge there is not, in the literature available, an evaluation and validation of these methods concerning AUV applications. In fact, there seems to be lacking an established approach for AUV parameter estimation that would allow for the computation of the associated modeling errors.

The short term goal of my research effort is to bring together different techniques for AUV parameter estimation that include analytical and semi-empirical methods (ASE) and to use them to predict the hydrodynamic derivatives of a large class of AUVs with conventional, streamlined bodies, in the vertical (dive) and horizontal planes. The long term plan is to complement these approaches with CFD techniques and to evaluate the accuracy of the different parameter estimation methods through a restricted number of tests with reduced or full scale vehicles in hydrodynamic tanks or at sea, respectively. These goals will be pursued in cooperation with the Department of Engineering Cybernetics, Norwegian University of Science and Technology (NTNU), Trondheim, Norway, and the National Institute of Oceanography (NIO), Dona Paula, Goa, India with whom collaborative research programs have been established. The NTNU has the facilities required to run hydrodynamics tank tests, while NIO has agreed to run AUV CFD analysis using parallel computing facilities available in India. In a more general setting, the work proposed aims to contribute to the development of computational methods for combined plant/controller optimization, that is, for the combined design of AUVs and controllers for increased performance at sea. Previous work in this area can be found in [3].

Bibliography:

[1] H. Bohlmann. *Berechnung Hydrodynamischer Koeffizienten von Ubooten zur Vohrhersage des Bewegungsverhaltens*. PhD Thesis. Institut fur Schiffbau der Universitat Hamburg, 1990.

[2] D. Humphreys, "Correlation and Validation of a CFD Based Hydrodynamic and Dynamic Model for a Towed Underwater Vehicle," Proc. OCEANS'01 Conference, USA, 2001.

[3] C. Silvestre. *MultiObjective Optimization Theory with Applications to the Integrated Design of Controllers / Plants for Underwater Vehicles*. PhD Thesis. Instituto Superior Técnico, Lisbon, 2000.

Results :

Analytical and Semi-Empirical Methods for the estimation of AUV hydrodynamic derivatives were studied and applied to the estimation of the hydrodynamic derivatives of the MAYA AUV, an autonomous vehicle that is being developed under a joint Indian-Portuguese project. The parameter estimates were used to predict the behavior of the vehicle in the vertical plane and to assess the impact of stern plane size on its expected performance. The methodology for parameter estimation is currently being automated using MatLab for two representative vehicle hull shapes.

Documents:

E. Barros and A. Pascoal, "AUV Dynamics: Modeling and Parameter Estimation using Analytical and Semi-Empirical Methods," DSORL-ISR Technical Report, October 2003.

Status:

Pending submission to a Journal and to the IFAC Conference on Control Application in Marine Systems, 7 - 9 July, 2004, Ancona, Italy.

3.3 THESES

In this section the Doctoral and Master theses concluded, or in progress, during 2003 at ISR-Lisbon are identified. In Charts 1 and 2 below the distribution by group/area of Ph.D. and M.Sc. theses is displayed.

CHART 1

Ph.D. Theses

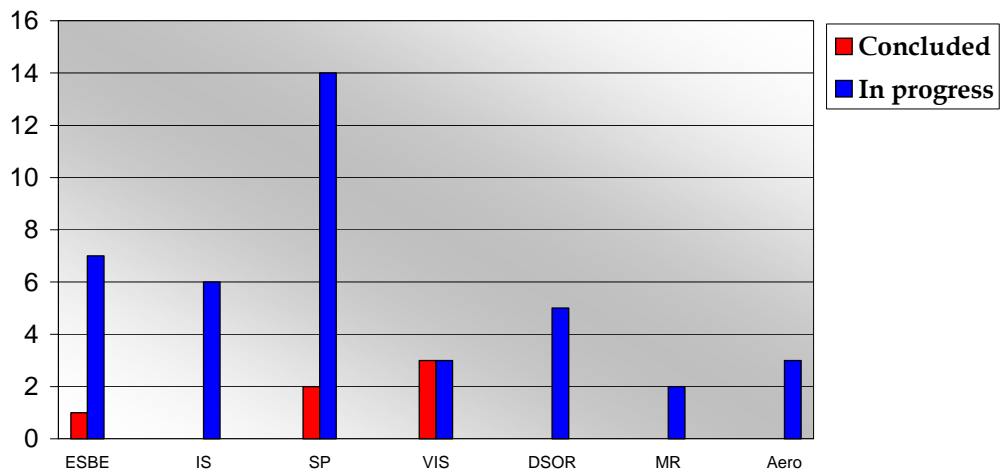
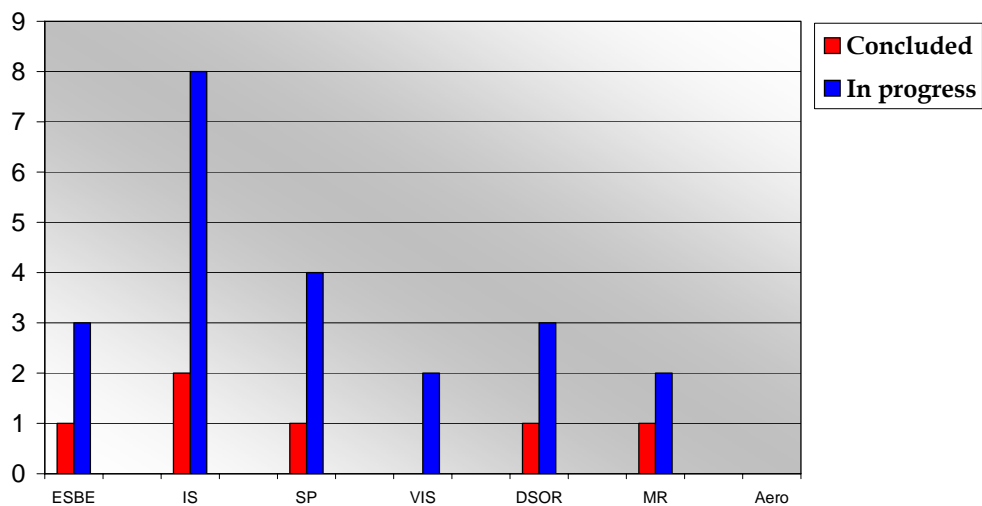

CHART 2

M.Sc. Theses



In the following a more detailed description of each thesis is given.

3.3.1 THESES CONCLUDED DURING 2003

DOCTORAL THESES (6)

João Raposo Sanches, "3D Bayesian Reconstruction from Ultrasound Sequences", Instituto Superior Técnico, March 2003.

Abstract:

Current 2D ultrasound systems provide cross sections of the human body in real time. The interpretation of ultrasound images is a difficult task requiring a high degree of specialization. In the last few years, considerable effort has been made in the development of complementary systems to provide 3D representations of human organs in order to assist the medical diagnosis. However, this problem has not been satisfactorily solved yet, and it is the central theme of this work.

This thesis presents methods for the three dimensional reconstruction of the human anatomy from sequences of ultrasound images. This operation, raises several difficulties because some regions are not intersected by any inspection plane, and the acquired images present low quality. The images are corrupted by multiplicative noise, they are misaligned and they are pre processed by the ultrasound equipment which performs a non linear and unknown compression of the data.

This thesis proposes a method for three dimensional reconstruction of regions of interest, in a bayesian framework, using interpolation functions to represent the function to estimate. The noise of the observations is represented by a Rayleigh distribution which is in accordance with the multiplicative type of the speckle noise, and the coefficients that define the region of interest are modeled by a Gibbs prior.

Statistical methods are also proposed to perform the alignment of the observed images, and to estimate and compensate for the pre processing operation. These methods are based on the optimization of a common objective function and they are alternately applied during the reconstruction process. The thesis also presents speed up methods for the 3D reconstruction, in order to make the proposed methods useful for interactive medical diagnosis.

The developed methods are assessed through experimental tests using synthetic and real data.

Keywords:

3D ultrasound, registration, logarithmic compression, speckle, medical image, Bayesian reconstruction.

Members of the thesis committee:

Prof. Paulo Jorge dos Santos Gonçalves Ferreira, UA (P)

Prof. Aurélio Joaquim de Castro Campilho, FEUP (P)

Prof. João José dos Santos Sentieiro, IST (P)

Prof. Jorge dos Santos Salvador Marques, IST (P)

Prof. Mário Alexandre Teles de Figueiredo, IST (P)

Jacinto Nascimento, "Robust Shape Estimation and Tracking in the Presence of Clutter", Instituto Superior Técnico, April 2003

Abstract:

This thesis proposes robust methods for the estimation and tracking of objects boundaries in images. There are several well known methods for contour estimation and tracking using deformable models. However, these methods have strong limitations. Their performance is severely hampered in the presence of outliers, i.e., image features detected which do not belong to the object boundary and this happens in most of the practical applications.

The goal of this thesis is to improve the performance of existing methods in the presence of outliers. This thesis

proposes robust versions for three contour estimation algorithms: Snakes, Kalman tracker, and Multi model Kalman tracker. The first one is a pioneering contour estimation algorithm for static objects. The last two are tracking methods for the estimation of motion objects in image sequences. The Kalman tracker is the most popular method for tracking deformable objects using active contours. The Multi model tracker is a recent method and it is based on the use of multiple dynamic models switched according to a Markov process, being useful to represent complex motions.

In this work we propose robust versions of the three methods using statistical models to represent valid and invalid observations. The proposed algorithms share the following properties. First, they are based on the use of middle level features (contour strokes) instead of low level ones (edge points) which are used in the original methods. Second, the detected features are not all considered as valid, since we know that some of them are outliers.

In this thesis, confidence degrees are assigned to each feature or a set of features, and the contour estimates are based on these confidence degrees. Features with high confidence degrees have a large influence on the shape estimates, while features with low confidence degrees have a negligible influence. A set of tests are presented to evaluate the performance of the proposed algorithms in shape estimation and tracking. It is concluded that the performance of the proposed methods is much better than the one obtained with the original algorithms.

Keywords:

Shape analysis, Tracking, Robust estimation, Active contours, Adaptive Snakes, Multi-Model tracking.

Members of the thesis committee:

Prof. Gilles Celeux, INRIA (F)

Prof. Arnaldo Joaquim de Castro Abrantes, ISEL (P)

Prof. João Manuel Lage de Miranda Lemos, IST (P)

Prof. Jorge dos Santos Salvador Marques, IST (P)

Prof. José Alberto Rosado dos Santos Victor, IST (P)

Prof. José Manuel Bioucas Dias, IST (P)

José A. Gaspar, "Omnidirectional Vision for Mobile Robot Navigation", Ph.D. Thesis, Instituto Superior Técnico, May 2003, Lisboa, Portugal.

Abstract:

The research, described in the thesis, concerns the visual navigation of indoor robots, emphasising the aspects of sensor design, environmental representations, accurate self-localisation and interaction with humans. The main point is that by exploring these different aspects, in a combined manner, an effective navigation system is obtained.

Sensor design is an enabling key for creating environmental representations adequate for accurate localisation. We present a system capable of self-localising using only a single omnidirectional camera, explicitly taking into account the nature of navigation task at hand in the design process.

We detail the geometry, termed the Spherical Projection Model, associated with omnidirectional cameras using spherical mirrors. We show that minimal error is induced by not having a single centre of projection. Methods used to obtain the bird's eye (orthographic) view of the ground are presented. This representation significantly simplifies the solution to navigation problems, by eliminating any perspective effects.

In order to achieve effective interaction with humans, we provide an intuitive user interface for target selection, built from an omnidirectional image. The models generated provide a rich scene description, which the user is free to rotate and translate. Reconstruction from a single image is possible with limited user input in the form of co-linearity or coplanarity properties.

We provided real world experimental results showing that our algorithms achieve highly precise navigation in several situations. Omnidirectional vision is shown to be beneficial for such tasks as docking and door traversal. Combined experiments, involving long distance navigation are also detailed.

The developed methodologies facilitate autonomous or guided exploration (tele-operation) and human-robot interaction.

Keywords:

Omnidirectional Vision, Navigation, Human-robot interfaces, Interactive Reconstruction.

Members of the thesis committee:

Prof. João José dos Santos Sentieiro, IST, (P).

Prof. Helder de Jesus Araújo, Univ. Coimbra (P).

Prof. Maria Isabel Lobato de Faria Ribeiro, IST, (P).

Prof. José Alberto Rosado dos Santos Victor, IST, (P).

Prof. Kostas Daniilidis, Univ. Pennsylvania, (USA).

Prof. Pedro Manuel Urbano de Almeida Lima, IST, (P).

Nuno R. E. Gracias, "Mosaic-based Visual Navigation for Autonomous Underwater Vehicles", Ph.D. Thesis, Instituto Superior Técnico, June 2003, Lisboa, Portugal.

Abstract:

The underwater environment poses a difficult challenge for autonomous vehicle navigation. Common positioning solutions require the deployment of precisely located acoustic beacons, which typically implies high operating costs. Vision sensing is increasingly being regarded as a low cost alternative, but is limited to short range due to visibility and lighting factors. However, it can provide precise positioning if an adequate representation of the environment is found. Video mosaicing presents itself as a suitable technique to overcome the limited underwater field-of-view.

This thesis addresses the problem of creating accurate video mosaics, capable of serving as navigation maps for autonomous vehicles operating close to the sea -floor. It is devised for mission scenarios where a robotic platform is required to map an approximately flat area of interest and to navigate upon it afterwards.

The first part of this work presents a methodology for the simultaneous creation of mosaics and the estimation of the camera trajectory. Mosaicing is performed in a fully automatic manner and attains full spatial coherence by exploring time-distant superpositions, such as the ones arising from loop trajectories or zig-zag scanning patterns.

Next, the problem of the pose estimation using a previously constructed mosaic is addressed. A direct algebraic solution is presented the case of known camera intrinsics, which is refined with a maximum likelihood estimator. The associated uncertainty is computed by propagating the covariance from image measurements to the pose estimates.

The last part illustrates the use of mosaic maps for autonomous navigation. A set of efficient routines is required for the accurate localization of the vehicle with respect to the mosaic, taking into account the operating requirements of real-time position sensing, error bounding and low computational load. A trajectory generation module is used to guide the navigation over well defined areas of the mosaic, where the visual based positioning is most reliable. The control signals are generated using a visual servoing strategy.

In order to assess the performance of the overall system, a Remotely Operated Vehicle was used under real operating conditions. Extensive testing was performed at sea, where the vehicle was able to autonomously navigate over previously created mosaics for large periods of time. This work demonstrates that, without resorting to additional sensors, visual information alone can be used to create environment representations of the sea bottom and support long runs of navigation.

Keywords:

Vision based navigation, projective geometry, underwater robots, video mosaics.

Members of the thesis committee:

Prof. João José dos Santos Sentieiro, IST (P).
Prof. Shahriar Negahdaripour, Univ. Miami (USA).
Prof. Emanuele Trucco, Heriot-Watt Univ. (UK).
Prof. José Alberto Rosado dos Santos Victor, IST (P).
Prof. João Paulo Salgado Arriscado Costeira, IST, (P).
Prof. Paulo Jorge Coelho Ramalho Oliveira, IST, (P).

Raquel Frizzera Vassalo , "Motor Representations for Topological Navigation and Ego-Motion based on Omnidirectional Images", Ph.D. Thesis qualify, UFES, March 2003, Vitória, Espírito santo, Brasil.
--

Abstract:

We propose an approach that allows a robot to use motor representations for learning a task through imitation. As suggested by recent findings in neuroscience, the robot relies on a visuomotor map to convert visual information into motor data. By observing and imitating other agents, the robot can then learn a set of elementary motions (motor vocabulary), that will eventually be used to compose more complex actions, for each specific task. We illustrate the approach with a mobile robot. Egomotion estimation is used as a visuomotor map for a mobile robot that learns a motor vocabulary for topological mapping and navigation. The approach can be extended to different robots and applications. Encouraging results are presented and discussed.

Keywords:

Omni-directional vision, mobile robot navigation, topological navigation, vision based control

Members of the thesis committee:

Prof. Mário Campos, Universidade Federal Minas Gerais, (Br).
Prof. Anna Reali, Escola Politécnica Universidade de São Paulo, (Br).
Prof. Mário Sarcinelli, Universidade Federal Espírito Santo, (Br).
Prof. José Santos-Victor, IST, (P).
Prof. Hans-Jorg Schneebeli, Universidade Federal Espírito Santo, (Br).

Tito Silva , "Representação e Reconhecimento de Objectos Visuais" PhD Thesis, Instituto Superior Técnico, April 2003, Lisboa, Portugal.
--

Abstract:

This thesis presents a new model of visual objects representation able to acquire, learn, recognise and reconstruct abstract visual concepts in an unsupervised way, based on visual properties of the environment.

Its applications are in the domain of mobile robotics, namely in detection and segmentation of visual features. The model also establishes hypothesis for the mechanisms that enable recognition in the Inferotemporal Cortex, thus helping investigation in that area.

This work consists in an autonomous system of analysis applied to a Neural Network.

The model has the property of recognising objects independently of their location or orientation. It is also able to perform objects segmentation into several coherent structures, with high probability of corresponding to independent objects. The model may reconstruct a partially occluded object, using a learnt abstract idea.

The model has been tested with real images. It segmented and recognised successfully several objects, thus producing promising results. The model was also able to deal with occlusions, thus showing to have an abstract representation of the presented visual concept.

The main original contributions of this work are: (1) ability to create abstract concepts, in an unsupervised way; (2) definition of a new paradigm of visual structures recognition and reconstruction; (3) simultaneous recognition of several objects inside one image; (4) robustness to objects location and orientation (with tolerance to scale and geometric distortions); (5) ability to reconstruct occluded areas of recognised objects.

Keywords:

Image Processing, Unsupervised Learning, Visual Cortex, Visual Concepts Representation, Neural Networks, Object Recognition

Members of the thesis committee:

Prof. João Sentieiro, IST, (P)

Prof. José Carlos Príncipe (USA)

Prof. Agostinho Rosa, IST, (P)

Prof. Mario Rui Gomes (P)

Prof. Mario Figueiredo, IST, (P)

Prof^a Bernadete Ribeiro (P)

Prof. Afonso Barbosa, IST, (P)

MASTER THESES (6)

Sérgio Guerreiro "Reorganização Dinâmica de Processos Face a Situações de Crise : Aplicação em Exemplos Robóticos e Empresariais Simplificados" Instituto Superior Técnico, May 2003, Portugal

Abstract:

Since the early days of automation that the definition of autonomous mechanisms to adapt systems to the changes in the real world is a key issue. Although the significant technological and theoretical improvements it still remains an open issue, specially for complex systems.

In the business context, this issue represents the constant need to adapt the business to the new market conditions in order to reach the enterprise strategic goals.

In the robotics context, navigation in unstructured realistic environments is still a challenging problem. Frameworks for the design of control architectures are still of limited use.

The thesis proposes a methodology to address the detection and correction of exception situations occurring in the operation of a generic process. Control processes in behavioral robotics are identified with business processes and it is shown that the same framework can be used to have both classes of systems adapting to unexpected changes in the real world.

Keywords:

Reorganização Dinâmica , Processos de Negócio

Members of the thesis committee:

José Tribolet, IST, (P)

Prof. Pedro Lima, IST, (P)

Prof. João Sequeira, IST, (P)

Tiago Filipe Galhoz Patrão, "Tracking a Mobile Binary Source in Wireless Systems with Spatial Diversity", Instituto Superior Técnico, December 2003.

Abstract:

In this thesis we tackle the joint source symbol detection and multi-channel acquisition problem in the context of wireless digital flat-fading links with space diversity. Our approach is based on a statistical model which decouples the time dynamics of the multi-channel vector in amplitude and direction. We compute the most probable emitted symbol sequence and channel realization for this statistical model, given the set of array observations. Our maximum a posteriori (MAP) receiver consists of a bank of parallel processors. Each processor finds the most probable channel realization for a given symbol sequence via two types of algorithms: the initialization algorithms and the refining algorithms. We develop two algorithms of the first type: a re-formulation of the original estimation problem into a semidefinite programming (SDP) and a scheme based on an interior point method (IPM) that solves an approximation of the optimization problem associated with the MAP estimator. For the second type we construct two iterative algorithms: a Karush-Kuhn-Tucker (KKT) method and a second order geodesic descent scheme that fully exploits the curvature of the constraint surface. A final algorithm is obtained by concatenating the best method in each type. Computer simulations that assess the capability of all our methods in acquiring fast-changing flat-fading channels are included.

Keywords:

Joint source symbol detection and multi-channel acquisition, Wireless digital flat-fading links, Space diversity, Statistical channel models, Maximum a posterior estimator, Semidefinite programming, Interior point method, Karush-Kuhn-Tucker method, Second order geodesic descent method.

Members of the thesis committee:

Prof. José Manuel Fonseca de Moura, CMU, (USA)

Prof. José Manuel Leitão, IST, (P)

Prof. Victor Alberto Neves Barroso, IST, (P)

Prof. João Manuel de Freitas Xavier, IST, (P)

João Paulo Caldeira, "Hybrid Taboo Search Algorithm for Jobshop Problem", MSc Thesis, Instituto Superior Técnico, October 2003, Lisboa, Portugal.

Abstract:

In this thesis we investigate 3 approaches to solving the general job shop problem:

- Evolutionary Algorithms
- Tabu Algorithms
- Hybrid Evolutionary Tabu Algorithms

The objective of the thesis is to find a process to hybridise heuristics that was not only extensible to other combinatorial problems but also competitive with the best know algorithms for these problems.

The job shop problem was chosen because it is a difficult problem with several good benchmark problems available that have been solved by many approaches over the years. These characteristics make the ideal for comparing the quality of different approaches similar combinatorial problems.

We conclude that although evolutionary algorithms are not competitive when applied by themselves, they can be used to improve results obtained using other methods such as Tabu. In order to test the hybrid algorithm, we chose the benchmark problems on which the Tabu had a poorer performance. On these problems, the hybrid achieved an average improvement of 2,9% on Tabu results. This achievement is even more noteworthy because the average distance between the hybrid and the best know results is under 1%.

Keywords:

Evolutionary, Tabu, Hybrid, Job Shop

Members of the thesis committee:

Prof Fernando Lobo , Universidade do Porto (P)

Prof Luis Custódio, Instituto Superior Técnico (P)

Prof Agostinho Rosa, Instituto Superior Técnico (P)

Rodolfo Oliveira, "Supervision and Mission Control of Autonomous Vehicles," Instituto Superior Técnico, October 2003, Portugal.

Abstract:

The present work tackles the problem of autonomous robotic vehicles mission design and execution in distributed environments. All computational phases from mission plan edition and mission program generation to real time mission execution in each of the systems on board the vehicle are addressed.

The multi-vehicle mission editor, that composes the mission plan and automatically generates the mission program, is a fundamental tool to autonomous vehicles system designers who strive to develop vehicles that can be programmed and operated by end-users that are not necessarily familiarized with the engineering details of vehicle technology. The mission program, automatically generated from the mission plan, is written in CORAL that is a Petri Net description language and execution system developed at ISR.

In the proposed solution, all the responsible mechanisms for the interaction among the systems onboard the vehicle, the modeling entities, and the mission plan supervisors are embodied in hierarchical Petri nets. Designing a controller that limits the original Petri net reachable state space then enforces the required behavior of each Petri net building block. The controller, that is itself a Petri net, is synthesized by resorting to the well know concept of place invariant. This technique together with the hierarchical structure proposed for the mission program leads to deadlock free mission control strategies, insures liveness, and enforces direct and indirect conditions on allowable events during the mission execution.

The work presented in this thesis was the basis for the implementation of the autonomous underwater Infante vehicle mission control, which was tested in several missions at sea.

Keywords:

Autonomous vehicles, mission edition, mission control, Petri nets, discrete event systems.

Members of the thesis committee:

Prof. Pedro Lima, Instituto Superior Técnico, (P)

Prof. Luís Gomes, Faculdade de Engenharia da Universidade Nova de Lisboa, (P)

Prof. Carlos Carneira, Instituto Superior Técnico, (P)

Prof. Carlos Silvestre, Instituto Superior Técnico, (P)

Marcia Maças "Sociedade de Agentes Autónomos Aplicação de uma Arquitectura baseada em Emoções", Instituto Superior Técnico, April 2003.

Abstract:

The role of emotions in human intelligence and social behaviours has been considered very important in the past few years. Aiming to model this contribution in autonomous agents, in this thesis are presented the results of using DARE architecture, an emotion-based architecture, in multiple agents environment. The goal was to evaluate the architecture performance in these environments, and to improve it in order to solve the problems related to them. Emotions are used at the individual decision level, through the modelling of the somatic marker hypothesis, and are used on decisions that involve others, using the same hypothesis and adding the notion of sympathy. The representation of other agents external expression allows to infer their internal state. This process is based on the assumption that similar agents express their internal state in similar way, being a mean of implicit communication. Sympathy allows more informed individual decisions, specially when these depend on others, and on the other hand to make agents learn, not only with their own experience, but also with others experience, increasing variety. Besides implicit communication, it is also used explicit communication, through messages exchanging. In order to do so a new layer was introduced in the architecture, the symbolic layer, in which interactions between agents are represented and used to improve individual and social behaviours.

Keywords:

emotions, agents, autonomy, social, artificial intelligence, architectures.

Members of the thesis committee:

Prof. Carlos Pinto-Ferreira, IST, (P)
Dr. Paolo Petta, Viena University, (Austria)
Prof. Pedro Lima, IST, (P)
Prof. Luis Custódio, IST, (P)

<p>Pedro Vale, "Aprendizagem num Agente Baseado em Emoções: Aplicação de Aprendizagem por Reforço", Instituto Superior Técnico, April 2003.</p>
--

Abstract:

This work has as its main goal the study and implementation of learning mechanisms in an Emotion Based Agent in order to allow this agent to survive in a complex environment. The agent should be able to adapt to its environment and to behave in an intelligent way. More specifically, this work describes an Emotion Based Architecture used together with a Reinforcement Learning system. The architecture in which the architecture presented in this work was based was developed at the Institute for Systems and Robotics. This architecture is essentially based on Antonio Damasio's work on the role emotions play in human decision making. In the context of this work, Reinforcement Learning is a formal decision-making process that can be influenced by the emotional architecture's output. This work tries to determine the range of this influence, as well as the benefits that the use of Reinforcement Learning can bring to the emotion based architecture. Furthermore, the influence that the emotion based architecture has in the Reinforcement Learning performance is also studied. In order to answer these questions, the architecture was implemented in a complex environment and the agent's behavior was analysed and compared with different approaches.

Keywords:

Emotions, Reinforcement Learning, Autonomous Agents, Machine Learning, Artificial Intelligence

Members of the thesis committee:

Prof. Carlos Pinto-Ferreira, IST, (P)
Dr. Paolo Petta, Viena University, (Austria)
Prof. Arlindo Oliveira, IST, (P)
Prof. Luis Custódio, IST, (P)

3.3.2 THESES IN PROGRESS DURING 2003

In this subsection the Doctoral and Master theses in progress during 2003, at ISR/IST (ECE) and ISR/Algarve (ECE), are identified and ordered by the scientific research area.

DOCTORAL THESES (40)

Research area: Artificial Intelligence
Title: Emotion-based Agents
Doctoral Student: Rodrigo Ventura
Advisor: Carlos Alberto Pinto-Ferreira
Initiated: 2001
Expected conclusion: 2004
Current status: On-going
Grant:
Documents produced in 2003:

Research Area: Biological Systems, Stochastic Hybrid Systems
Title: Stochastic Model of Micro-Agent Populations
Doctoral Student: Dejan Milutinovic
Advisor: Pedro M. U. A. Lima
Initiated: September 2000
Expected conclusion: 2004
Current Status: On-going
Grant:
Documents produced in 2003: [65] , [66] .

Research Area: State Estimations for Satellite Formations
Title:
Doctoral Student: Sónia Marques
Advisor: Pedro M. U. A. Lima
Initiated: September 2001
Expected conclusion: 2005
Current Status: On-going
Grant:
Documents produced in 2003: [133] , [134] , [135] .

Research Area: Formation Control
Title:
Doctoral Student: Andrés García
Advisor: Pedro M. U. A. Lima
Initiated: March 2002
Expected conclusion: 2006
Current Status: On-going
Grant:
Documents produced in 2003: [67] , [133] , [135] .

Research area: Discrete-Event Based Modelling and Coordination of Robotic Tasks

Title:

Doctoral Student: Hugo Costelha

Advisor: Pedro Lima

Initiated: October 2003

Expected conclusion: 2007

Current status: On-going

Grant:

Documents produced in 2003:

Research area: Multi-Agent Reinforcement Learning for Stochastic Games

Title:

Doctoral Student: Gonçalo Neto

Advisor: Pedro Lima

Initiated: October 2003

Expected conclusion: 2007

Current status: On-going

Grant:

Documents produced in 2003:

Research Area: Computer Vision

Title: Binocular Visual Servoing and Visual attention

Doctoral Student: Alexandre Bernardino

Advisor: José Santos-Victor

Initiated: 1997

Expected conclusion: 2004

Current Status: Submitted

Grant:

Documents produced in 2003:

Research Area: Computer Vision

Title: Vision based Imitation

Doctoral Student: Manuel Cabido Lopes

Advisor: José Santos-Victor

Initiated: 2002

Expected conclusion: 2005

Current Status: On-going

Grant:

Documents produced in 2003:

Research Area: Computer Vision

Title: Image matching

Doctoral Student: Ricardo Oliveira

Advisor: João Paulo Costeira

Initiated: 2002

Expected conclusion: 2004

Current Status: On-going

Grant: FCT

Documents produced in 2003:

Research Area: Biomedical Engineering
Title: Sleep EEG Microstructure Analysis
Doctoral Student: Rogério Largo
Advisor: Agostinho Rosa
Initiated: 1996
Expected conclusion: 2005
Current Status: on-going
Grant: PRODEP
Documents produced in 2003:

Research Area: Evolutionary Systems - Scheduling
Title: Simulated Annealing in Resource Management
Doctoral Student: Fernando Melício
Advisor: Agostinho Cláudio da Rosa
Initiated: 1998
Expected Conclusion: 2004
Current Status: on-going
Grant:
Documents produced in 2003:

Research Area: Evolutionary Systems – Optimization and Image Enhancement
Title: AREA on-line decision EA
Doctoral Student: Cristian Munteanu
Advisor: Agostinho Cláudio da Rosa
Initiated: Jan 2001
Expected Conclusion: 2004
Current Status: Thesis writing
Grant: FCT
Documents produced in 2003:

Research Area: Artificial Life – Evolutionary Systems
Title:
Doctoral Student: Gong Hongfei
Advisor: Agostinho Cláudio da Rosa
Initiated: October 1999
Expected Conclusion: 2004
Current Status: on-going
Grant: FCT
Documents produced in 2003:

Research Area: Artificial Life – Social Systems
Title: Design and Development of Highly Flexible Organizations
Doctoral Student: Osvaldo Brasão
Advisor: Agostinho Cláudio da Rosa
Initiated: July 1999
Expected Conclusion: 2004
Current Status: Thesis Writing
Grant: FCT
Documents produced in 2003:

Research Area: NeuroSciences
Title:
Doctoral Student: Ernesto Soares
Advisor: Agostinho Cláudio da Rosa
Initiated: July 1999
Expected Conclusion: 2004
Current Status: on-going
Grant: Calouste Gulbenkian Foundation
Documents produced in 2003:

Research Area: Biomedical Engineering - Neuroscience
Title: Detection of Neurocognitions
Doctoral Student: José Luis Malaquias
Advisor: Agostinho Cláudio da Rosa
Initiated: September 2000
Expected Conclusion: 2004
Current Status: on-going
Grant:
Documents produced in 2003:

Research Area: Statistic based navigation of mobile robots in outdoors environments
Title: Mobile Robot Navigation in Outdoor Environments: A Topological Approach
Doctoral Student: Alberto Vale
Advisor: Maria Isabel Ribeiro
Initiated: 2000
Expected conclusion: 2004
Current Status: on-going
Grant: SFRH/BD/929/2000 from FCT
Documents produced in 2003: [75] .

Research Area: Control of a Mobile Robot Population
Title: Not yet available
Doctoral Student: Fernando Melo
Advisor: Maria Isabel Ribeiro
Initiated: December 2002
Expected conclusion: 2005
Current status: on - going
Grant: PhD grant from FCT
Documents produced in 2003:

Research Area: Image Compression
Title: Compressão de Vídeo para Aplicações Submarinas
Doctoral Student: Jorge Barbosa
Advisor: Victor Barroso
Initiated: 1996
Expected conclusion: 2004
Current Status: Submitted
Grant: PRODEP
Documents produced in 2003:

Research Area: Space/Time Coding
Title: Noncoherent Communication in Multi-Antenna Wireless Systems
Doctoral Student: Marko Beko
Advisor: João Xavier
Initiated: 2003
Expected conclusion: 2006
Current Status: on-going
Grant: PhD FCT Grant
Documents produced in 2003:

Research Area: Queuing Networks
Title: Not yet available
Doctoral Student: Nuno Manuel Rosa dos Santos Órfão
Advisor: Carlos Bispo
Initiated: 2002
Expected conclusion: 2005
Current Status: on-going
Grant:
Documents produced in 2003:

Research area: Video Segmentation
Title: Not yet available
Doctoral Student: Pedro M. Jorge
Advisor: Jorge S. Marques
Initiated: 2002
Expected conclusion: 2005
Current status: on going
Grant:
Documents produced in 2003:

Research Area: Image Processing
Title: Not yet available
Doctoral Student: Jorge G. Silva
Advisor: Jorge S. Marques
Initiated: 2003
Expected conclusion: 2005
Current Status: on going
Grant:
Documents produced in 2003:

Research area: image processing, visual psychophysics
Title: A new spatial brightness model
Doctoral Student: João Rodrigues
Advisor: Hans du Buf
Initiated: 1998
Expected conclusion: 2003
Current status: on going
Grant: PRODEP
Documents produced in 2003:

Research area: Processamento de Imagem em 3D
Title: 2D and 3D data Processing and visualization
Doctoral Student: Robert Loke
Advisor: Hans du Buf
Initiated: 1998
Expected conclusion: 2003
Current status: on going
Grant: European project ADIAC and ISACS
Documents produced in 2003:

Research area: Processamento de Imagem
Title: Models of cortical neurons in pattern recognition
Doctoral Student: Luis Santos
Advisor: Hans du Buf
Initiated: 2000
Expected conclusion: 2004
Current status: on going
Grant: FCT
Documents produced in 2003:

Research area: Computação Gráfica
Title: 3D object Reconstruction and Triangulation
Doctoral Student: Roberto Lam
Advisor: Hans du Buf
Initiated: 2001
Expected conclusion: 2005
Current status:
Grant:
Documents produced in 2003:

Research area: Processamento de Imagem
Title: Detection and brightness modes
Doctoral Student: Pedro Guerreiro
Advisor: Hans du Buf
Initiated: 2001
Expected conclusion: 2005
Current status: on going
Grant:
Documents produced in 2003:

Research area: Tomographic Data Assimilation
Title: Data Fusion Applied to Ocean Acoustic Tomography
Doctoral Student: Paulo Felisberto
Advisor: Sérgio de Jesus
Initiated: June 2000
Expected conclusion: 2004
Current status: on going
Grant: Teaching Assistant (PRODEP fellowship)
Documents produced in 2003: [21] , [69] , [138] .

Research Area: Array Signal Processing in Underwater Acoustics
Title: Array processing for ocean acoustic tomography on range-dependent environments
Student: Cristiano Soares
Advisor: Sergio M. Jesus
Initiated: February 2002
Expected conclusion: 2005
Current status: on going
Grant: FCT fellowship under project ATOMS
Documents produced in 2003: [23] , [70] , [137] , [139] , [140] .

Research Area: Signal Processing
Title: Oceanic parameter estimation using multi-dimensional representations of acoustic signals
Student: Nelson Martins
Advisor: Sergio M. Jesus
Date: September 2002
Expected conclusion: 2005
Current status: on going
Grant: FCT fellowship
Documents produced in 2003:

Research Area: Underwater Acoustic Communications
Title: Environmentally robust methods for underwater acoustic communications
Student: Antonio João Silva
Advisor: Sergio M. Jesus
Date: July 2003
Expected conclusion: 2006
Current status: on going
Grant: Teaching Assistant (PRODEP fellowship)
Documents produced in 2003: [139] .

Research Area: Control Theory
Title: Modeling and Path Following Control of Remotely Operated Vehicles (ROVs)
Doctoral Student: Danilo Carvalho
Advisor: Teodiano Filho (Univ. Federal Espírito Santo, Brasil) / António Pascoal
Initiated: 2002
Expected Conclusion: 2006
Current Status: research in progress
Grant: "Sandwich Doctoral Program" financed by the Brazilian Government.
Documents produced in 2003: [119] .

Research Area: Navigation
Title: Terrain Based Navigation of Autonomous Underwater Vehicles (AUVs)
Doctoral Student: Francisco Curado Teixeira
Advisor: António Pascoal / Hipólito Monteiro (Instituto Geológico e Mineiro - IGM)
Initiated: 2001
Expected Conclusion: 2005
Current Status: research in progress
Grant: FCT Graduate Scholarship
Documents produced in 2003: [59] , [60] , [130] , [131] .

Research Area: Control Theory
Title: Robust Multiple-Model Adaptive Control (MMAC) Based on μ -Synthesis
Doctoral Student: Sajjad Fekri Asl
Advisor: António Pascoal / Michael Athans
Initiated: 2002
Expected Conclusion: 2005
Current Status: research in progress
Grant: FCT Graduate Scholarship
Documents produced in 2003: [48] , [122] .

Research Area: Control Theory
Title: Path Following Control of Autonomous Vehicles
Doctoral Student: Reza Ghabcheloo
Advisor: António Pascoal / Carlos Silvestre
Initiated: 2002
Expected Conclusion: 2006
Current Status: research in progress
Grant: FCT Graduate Scholarship
Documents produced in 2003: [123] .

Research Area: Guidance and Control of Dynamic Systems
Title: Sensor-Based Guidance and Control of Robotic Vehicles
Doctoral Student: Rita Cunha
Advisor: Carlos Silvestre
Initiated: 2001
Expected Conclusion: 2005
Current Status: research in progress
Grant: FCT Graduate Scholarship
Documents produced in 2003: [49] , [51] , [53] , [54] , [120] , [121] , [126] , [129] .

Research Area: Aeroacoustics
Title: Acoustics of curved ducts and vertical flows
Doctoral Student: Pedro G.T.A. Serrão
Advisor: L.M.B.C. Campos
Initiated: 1999
Conclusion: 2004
Current Status: writing of the thesis
Grant:
Documents produced in 2003:

Research Area: Aeroacoustics
Title: Acoustics of nozzles with non-uniform impedance
Doctoral Student: João M. S. Oliveira
Advisor: L.M.B.C. Campos
Initiated: 1999
Conclusion: 2004
Current Status: obtaining final results and writing of the thesis
Grant:
Documents produced in 2003:

Research Area: FLIGHT MECHANICS
Title: Aircraft Separation in Air Traffic Management
Doctoral Student: J. Marques
Advisor: L. M. B. C. Campos
Initiated: 2000
Expected conclusion: 2004
Current Status: in progress
Grant:
Documents produced in 2003:

MASTER THESES (23)

Research Area: Artificial Intelligence
Title: Supply-Chains : an Multi-agent System Approach
Master Student: Rui Carvalho
Advisor: Luis Manuel Marques Custódio
Initiated: 2001
Expected conclusion: 2004
Current status: On-going
Grant:
Documents produced in 2003:

Research Area: Artificial Intelligence
Title: Emotion-based Agent Architectures
Master Student: Bruno Damas
Advisor: Luis Manuel Marques Custódio
Initiated: 2002
Expected conclusion: 2004
Current status: On-going
Grant:
Documents produced in 2003: [13] , [19] .

Research Area: Artificial Intelligence
Title: Agents with Personality : Applications to the Robotic Soccer Case-Study
Master Student: Carla Penedo
Advisor: Luis Manuel Marques Custódio
Initiated: 2002
Expected conclusion: 2004
Current status: On-going
Grant:
Documents produced in 2003: [63] , [103] .

Research Area: Artificial Intelligence
Title: Development of Coach Agent for a Robotic Soccer Team
Master Student: João Pavão
Advisor: Luis Manuel Marques Custódio
Initiated: 2002
Expected conclusion: 2004
Current status: On-going
Grant:
Documents produced in 2003: [63] , [103] .

Research Area: Artificial Intelligence
Title: Learning on a Multi-Agent Soccer Robotic System
Master Student: Pedro Nunes
Advisor: Luis Manuel Marques Custódio
Initiated: 2002
Expected conclusion: 2004
Current status: On-going
Grant:
Documents produced in 2003: [63] , [103] .

Research Area: Multi-Robot Sensor Fusion and World Modeling
Title:
Master Student: Pedro Pinheiro
Advisor: Pedro Lima
Initiated: 2003
Expected conclusion: 2004
Current status: On-going
Grant:
Documents produced in 2003: [104] .

Research Area: Artificial Intelligence
Title: Task Planning and Execution for a Multi-robot Team
Master Student: Miguel Arroiz
Advisor: Luis Custódio
Initiated: 2003
Expected conclusion: 2004
Current status: On-going
Grant:
Documents produced in 2003: [102] .

Research Area: Artificial Intelligence
Title: Learning and Logical Decision-Making for a Multi-Robot Team
Master Student: Vasco Pires
Advisor: Luis Custódio
Initiated: 2003
Expected conclusion: 2004
Current status: On-going
Grant:
Documents produced in 2003: [102] .

Research Area: Evolutionary Systems - BioChemistry
Title:
Master Student: Nelson Pereira
Advisor: Agostinho Rosa
Initiated: 2000
Expected Conclusion: 2003
Current Status: delivered
Grant: FCT
Documents produced in 2003:

Research Area: Evolutionary Systems
Title: Processamento de imagens em microscopio confocal
Master Student: Alexandre Calapez
Advisor: Agostinho Cláudio da Rosa
Initiated: 2002
Expected Conclusion: 2004
Current Status: Thesis Writing
Grant:
Documents produced in 2003:

Research Area: Evolutionary Systems - BioInformatics
Title: Model Based Functional Genomics
Master Student: Marcio Mourao
Advisor: Agostinho Rosa
Initiated: 2002
Expected Conclusion: 2004
Current Status: on-going
Grant:
Documents produced in 2003:

Research Area: Cooperative SLAM
Title: not yet available
Master Student: Zlatan Tatarov
Advisor: Maria Isabel Ribeiro
Initiated: 2002
Expected conclusion: 2004
Current Status: On-going
Grant:
Documents produced in 2003:

Research Area: Applied Robotics
Title: Inspeção e Manutenção Robótica em Linhas de Transporte de Energia Eléctrica de Alta Tensão
Master Student: José Inácio Rocha
Advisor: João Sequeira
Initiated: 2001
Expected conclusion: December 2004
Current Status: On-going
Grant:
Documents produced in 2003:

Research Area: Queuing Networks
Title: Not yet available
Master Student: Tiago Barroso
Advisor: Carlos Bispo
Initiated: 2002
Expected conclusion: 2004
Current status: on-going
Grant: ISR programmatic funding
Documents produced in 2003:

Research Area: Signal Processing, Communications
Title: Bayesian Signal Reconstruction in Wireless Comm. Systems with Spatial Diversity
Master Student: Paulo Lopes
Advisor: Victor Barroso
Initiated: 2000
Expected conclusion: 2004
Current status: submitted
Grant: POSI/38775/CPS/2001 research assistant
Documents produced in 2003: [87] .

Research Area: Video processing

Title: Modelos 3D densos a partir de imagens com sobreposição parcial: fatorização com dados desconhecidos

Master Student: Rui F. C. Guerreiro

Advisor: Pedro M. Q. Aguiar

Initiated: 2002

Expected conclusion: 2004

Current status: submitted

Grant: POSI/SRI/41561/2001 research assistant

Documents produced in 2003: [84] .

Research Area: Urban Traffic Control

Title: Melhoria da velocidade dos Transportes Públicos de Superfície em Lisboa por Regulação da Admissão de Trânsito.

Master Student: Manuel Augusto Vieira

Advisor: Carlos Bispo

Initiated: 2001

Expected conclusion: 2004

Current status: submitted

Grant:

Documents produced in 2003: final draf of dissertation concluded

Research Area: Real Time Systems

Title: Distributed Architectures for Real-Time Control

Master Student: João Alves

Advisor: Carlos Silvestre

Initiated: October 2002

Conclusion: 2004

Current Status: research in progress

Grant: FCT / MAROV project

Documents produced in 2003: [116] .

Research Area: Tracking Systems

Title: 2D Target Tracking and Prediction

Master Student: Pedro Alves

Advisor: Carlos Silvestre

Initiated: June 2001

Conclusion: 2004

Current Status: submitted

Grant: FCT Scholarship

Documents produced in 2003: [117] .

Research Area: Control of Autonomous Vehicles

Title: Terrain Tracking Strategies for Autonomous Vehicles with application to Unmanned Helicopters

Master Student: Nuno Paulino

Advisor: Carlos Silvestre

Initiated: April 2003

Expected conclusion: 2005

Current Status: research in progress

Grant: FCT/Alticopter Project

Documents produced in 2003: [126] , [128] .

Research Area: Real Time Systems
Title: a DSP Multiprocessing Architecture for Autonomous Vehicles
Master Student: José Lucas
Advisor: Carlos Silvestre
Initiated: November 2003
Expected conclusion: 2005
Current Status: research in progress
Grant: No Grant
Documents produced in 2003:

Research Area: Computer Vision
Title: Optimal methods for Image Matching
Master Student: Nuno Pinho da Silva
Advisor: João Paulo Costeira
Initiated: 2002
Conclusion: 2004
Current Status: On-going
Grant:
Documents produced in 2003:

Research Area: Computer Vision
Title: Augmented Reality without Calibration
Master Student: AlpeshKumat Narotam Ranchordas
Advisor: José Santos-Victor
Initiated: 2001
Expected conclusion: 2004
Current Status: Submitted.
Grant:
Documents produced in 2003:

3.4 DVANCED TRAINING

3.4.1 COURSES

João Sentieiro - PhD course (Post-Graduation on Electrical and Computers Engineering at IST) on "Optimization on Non-Linear Programing".

Pedro Lima - PhD course (Post-Graduation on Electrical and Computers Engineering at IST) on "Discrete Event Dynamic Systems".

Pedro Lima - MSc and PhD course (Post-Graduation on Electrical and Computers Engineering at IST) on "Mobile Robotics".

Luis Custódio - MSc Course (Post-Graduation on Electrical and Computers Engineering at IST) on "Artificial Intelligence".

Luis Custódio - MSc Course (Post-Graduation on Electrical and Computers Engineering at IST) on "Modelling and Control of Automated Manufacturing Systems".

Pedro M.Q. Aguiar and José A. Victor - Statistical and Computational Models of Vision - Doctoral Program course- 2nd Semester 2002/2003.

João Xavier - Nonlinear Signal Processing: Doctoral program course, 2nd semester 2003.

M. Isabel Ribeiro - M.Sc Course on Mobile Robotics, Instituto Superior Técnico, Lisbon, Portugal.

Pedro Lima - M.Sc Course on Mobile Robotics, Instituto Superior Técnico, Lisbon, Portugal.

José Santos-Victor - Statistical and computational Models of Vision, PhD Course, IST.

Agostinho Rosa - Signal processing in Clinical Neurophysiology, Pos-grad course in Medicine, FML "Biomedical Engineering - BioMed 02", Laseeb-ISR-IST, Set 2002

Michael Athans - a one semester doctoral level course "Dynamic Stochastic Estimation, Prediction And Smoothing "

Paulo Oliveira - a one semester doctoral level course "Dynamic Stochastic Estimation, Prediction And Smoothing "

Michael Athans - a one semester doctoral level course "Design of Robust Multivariable Feedback Control Systems"

Carlos Silvestre - a one semester doctoral level course "Design of Robust Multivariable Feedback Control Systems"

Carlos Silvestre - a three weeks open course "*Introduction to the Systhesis of Feedback Control Systems Using Linear Matriz Inequalities*"

António Pascoal - given at the 6th IFAC Conference on Manoeuvring and Control of Marine Craft , a 6 hour TUTORIAL "*Control of Autonomous Marine Vehicles*" University of Girona, Spain, September 16, 2003

3.4.2 SEMINARS

▪ During 2003 the following Seminars were given outside ISR:

João Xavier - Lower Bound on Intrinsic Variance of Estimators in Riemannian Manifolds, Mathematics, Systems and Robotics Seminar, 7 November 2003

P. Borgnat - Symétrie des champs bidimensionnels et générateurs stationnaires, in *Journées d'étude sur les Méthodes pour les signaux complexes en traitement d'image de l'ARC Thalweg*, Inria Rocquencourt, December 2003.

Alberto Vale - Simultaneous Localization and Mapping (SLAM), set of three seminars, offered together with Francisco Ribeiro, ISR, February 2003.

Alberto Vale - "A Robótica e a Inteligência Artificial", EPO - Jornadas 2003 na Escola Profissional de Ourém, April 2003.

M. Isabel Ribeiro - invited talk on "Autonomous Robots: origins and actual challenges" proferida no Encontro Técnico Sectorial "Electricidade, Electrónica e Telecomunicações" do Centro Nacional de Formação de Formadores do Instituto de Emprego e Formação Profissional, May 2003.

António Pascoal - "NAVIGATION, GUIDANCE, AND CONTROL OF AUTONOMOUS MARINE VEHICLES", a 4-hour SEMINAR given at the Department of Engineering Cybernetics, Norwegian University of Science and Technology (NTNU), Trondheim, Norway, September 23-24, 2003.

▪ Some ISR Laboratories, such as Vislab , DSOR lab and ESBE lab organize internal weekly meetings.

▪ ISR Seminar Meetings

In a regular basis, and organized by Paulo Oliveira, the following seminars were held:

Stabilization of Multi Class Queuing Networks

Carlos Bispo, Professor, ISR, IST
March 2003

Stochastic Model of a Micro Agents Population

Dejan Milutinovic, Ph.D. Student, ISR, IST
March 2003

Special Seminar

Dr. Augusto Caramagno, DEIMOS Space S.L.,
March 2003

Robot Formations Dynamics Based on Scalar Fields

Andres Garcia, Ph.D. Student, ISR, IST
March 2003

Special Seminar

Minoru Asada, President of the RoboCup Federation
March 2003

Non linear path following control : from Non-holonomic to underactuated vehicle, general description (part 1)

Lionel Lapierre, Post-Doc, ISR, IST
April 2003

Features Network, unsupervised 2D visual object modelling and recognition

Tito Silva, Ph.D. Student, ISR, IST

April 2003

Special Seminar

Mixture of linear mixed models for clustering gene expression profiles from repeated microarray experiments

Gilles Celeux, INRIA, Grenoble

April 2003

Array Processing Methods for Time-Reversed Underwater Communication Systems

João Pedro Gomes, Ph.D. Student, ISR, IST

May 2003

Yet another perspective on mobile robot control

João Sequeira, Professor, ISR, IST

May 2003

Robust Multiple-Model Adaptive Control (MMAC) Based on mu-Synthesis

Sajjad Fekri, Ph.D. Student, ISR, IST (Ph.D. Thesis Proposal)

May 2003

Non linear path following control of single and multiple underactuated vehicle, extensions (part 2)

Lionel Lapierre, Post-Doc, ISR, IST

May 2003

Gray-Scale Image Enhancement as an Automatic Process driven by Evolution

Cristian Munteanu, Ph.D. Student, ISR, IST

June 2003

Pattern analysis of micro-array data: gene clustering, gene selection, and sample classification

Mário Figueiredo, Instituto de Telecomunicações, IST

June 2003

Position Tracking of Underactuated Vehicles

Pedro Aguiar, Post-Doctoral Researcher, University of California, Santa Barbara

June 2003

Special Seminar organized by Prof. José Santos Victor

General Solution for Linearized Error Propagation in Odometry

Dr. Alonzo Kelly, Robotics Institute, CMU

June 2003

Special Seminar

Some Results in Application of Intelligent Control for Robotic Systems

Dr.Eng, Dusko KATIC, Robotics Laboratory, Mihailo Pupin Institute, Belgrade, Serbia

July 2003

Terrain following preview controller for model-scale helicopters

Nuno Paulino, Msc. Student, ISR, IST

October 2003

Tracking Groups of Pedestrians in Video Sequences

Jorge Salvador Marques, Professor, ISR, IST

October 2003

Omnidirectional Vision for Mobile Robot Navigation

José Gaspar, Professor, ISR, IST

October 2003

Fisher information and Physics

João Leonardo,
October 2003

Scale invariance for signals and images and stationarization

Pierre Borgnat, Post-Doc, ISR, IST
November 2003

3.4.3 READING GROUPS

Reading group on Computer Vision (VISLAB)

Reading group on Evolutionary Computation and Biomedical Signal Processing and Classification (ESBE)

3.4.4 VISITS ABROAD

Pedro Lima, Hugo Costelha, Gonçalo Neto, Pedro Pinheiro, Miguel Arroz, Vasco Pires, Carla Penedo, João Pavão and João Frazão participated in *RoboCup 2003*, in Padova, 1-12 July, in the Soccer Middle-Size and Simulation leagues (ISocRob team).

Pedro Lima participated in a meeting of the Executive Committee of the RoboCup Federation, in Blaubeuren, Germany, 4-6 October

Rita Cunha - Spent three months, from August to November 2003, at the University of California Santa Barbara, USA, working with Prof. João Hespanha in the area of Sensor Based Guidance and Control of Autonomous Vehicles within the scope of her PhD research program and the ALTICOPTER project.

Paulo Oliveira, António Pascoal, and Carlos Silvestre (two weeks in April 2003)- visited the National Institute of Oceanography (NIO), Dona Paula, Goa, India in the scope of the MAYA-Sub project that aims at the development of two similar AUVs for operations in Portugal and in India. During the visit, the discussion centered around the issues of AUV system design and implementation. In the final part of the mission, the Portuguese delegation visited with Dr. H. Gupta of the the Ministry of Ocean Development and Dr. A. Kalra of the Department of Science and Technology of the Ministry of Science to further enhance the cooperation links between India and Portugal.

3.4.5 SUPERVISION OF STUDENTS ENROLLED IN FOREIGN UNIVERSITIES

Maria Isabel Ribeiro - José Miguel Lucas PhD student of the University of Murcia, Spain - two month period at ISR/Mobile Robotics Laboratory working on the problem of feature extraction for topological map representation.

José Santos-Victor - co-supervisor of Raquel Vassallo, PhD student at the University of Espírito Santo, Vitória, Brasil.

José Santos-Victor - co-supervisor of Cláudia Deccó, PhD student at the University of São Paulo, Brasil.

José Santos-Victor - co-supervisor of Vicente Javier Traver, Post Doc, University Jaume I, Castellon, Spain

Agostinho Rosa - Ernesto Soares , Duke University , USA

Agostinho Rosa - Roberta Vieira , Universidade Federal de Pernambuco , Brazil

António Pascoal - Co-supervision by Prof. Teodiano Filho (Univ. Federal Espírito Santo - UFES, Vitória, Espírito Santo, Brasil) of the PhD research program of Danilo Carvalho, a PhD student enrolled at UFES, doing a "Sandwich Doctoral Program" financed by the Brazilian Government. The main topic of his PhD thesis is Modeling and Path Following Control of Remotely Operated Vehicles (ROVs)

3.5 CONGRESS, MEETINGS AND PRESENTATIONS

This section includes invited talks, conferences attended and conferences where papers were presented, during 2004, by ISR-Lisbon researchers.

3.5.1 INVITED TALKS

Agostinho Rosa - "Padrão Alternante Cíclico" CBS 2003, Vitória, Brasil, Novembro de 2003

Agostinho Rosa - "EA in games and telecommunications" MPTP 2003, Tomar, 11 Setembro de 2003

Agostinho Rosa - "Application of Evolutionary Computation in Signal and Image Processing in BioMedicine", BioEng03, Lisboa, 27 de Junho 2003.

Agostinho Rosa - "Detecção Automática de padrão cíclico alternante (CAPS)", APS 03, Ponta Delgada, Açores, 11 de Outubro 2003.

Agostinho Rosa - "Sistema integrado de Simulação e Apoio à Protecção de Plantas: Mosca da Oliveira e Mildio da Videira", DGPC, Ministério da Agricultura e Pescas, 7 de Julho de 2003.

Agostinho Rosa - "Modelo Unificado de geração do EEG do Sono", AFIP, São Paulo, Abril 2003.

Agostinho Rosa - "Detecção baseada em modelos de Eventos fásicos do sono", AFIP, São Paulo, Abril 2003.

Agostinho Rosa - "Classificação Automática do CAP através de filtragem adaptativa", AFIP, SaoPaulo, Maio de 2003.

António M. Pascoal - "Marine Robots: Instruments for Ocean Exploration," PLENARY SESSION, 5th IFAC International Symposium on Intelligent Components and Instruments for Control Applications, Aveiro, Portugal, July 9 - 11, 2003.

António M. Pascoal - "Marine Robots: from Theory to Practice," PLENARY SESSION, 11th International Conference on Advanced Robotics, ICAR 2003, Coimbra, Portugal, June 30 - July3, 2003.

António M. Pascoal - "Marine Robots for Ocean Exploration: Theoretical Challenges and Practical Issues," PLENARY SESSION, IFAC Workshop on Guidance and Control of Underwater Vehicles, Newport, South Wales, UK, April 2003.

António M. Pascoal - "Navigation, Guidance, and Control of Ocean Robots," DII, University of Lecce, Italy, January 2003

António M. Pascoal - "Autonomous Marine Robots: Tools for Ocean Exploration," DII, University of Lecce, Italy, January 2003

Carlos Silvestre - "On the Design of Gain Scheduled Static Output Feedback Controllers for Autonomous Underwater Vehicles," National Institute of Oceanography, Dona Paula, Goa, India, April, 2003.

Carlos Silvestre - "Mission and Vehicle Control of Autonomous Ocean Robots, International Workshop on Marine Technologies," in the scope of a workshop organized by the Alfred-Wegener-Institut (AWI), Bremen University, Max-Planck-Institut (MPI), Hochschule Bremerhaven, Bremerhaven, Germany, 17 and 18 of March 2003.

Jorge S. Marques - "Seguimento Robusto de Objectos Usando Modelos Deformáveis", 12º Encontro Português de Computação Gráfica, Porto, Outubro 2003.

Pedro Lima - "O Projecto SocRob", III Jornadas de Engenharia Electrotécnica e de Computadores, JEEC2003, 1 Abril de 2003

Pedro Lima, Luis Custódio - "SocRob - Soccer Robots ou Society of Robots ", Encontro Nacional de Futebol Robótico, Instituto Superior de Engenharia do Porto, 16-18 February

Pedro Lima - "The Institute for Systems and Robotics", presentation to the European Space Agency, Lisbon, 15 April

Pedro Lima - "O que vai ser o RoboCup 2004? e SocRob - Soccer Robots ou Society of Robots ", U. Aveiro, 7 October

Pedro Lima - "Futebol Robótico: Investigação. Educação e Promoção de Ciência e Tecnologia", Instituto de Sistemas e Robótica, U. Coimbra, within the frame of *Coimbra 2003 - Portuguese Culture Capital*, 18 December

3.5.2 PROMOTION OF SCIENCE AND TECHNOLOGY AMONG THE YOUTH

Pedro Lima made presentations and demonstrations on Robotics to High School students: 21 January, *Escola Secundária da Sobreda*

Pedro Lima made presentations and demonstrations on Robotics to High School students: 14 January, *Escola Pública Profissional de Electrónica e Telecomunicações*

Pedro Lima made presentations and demonstrations on Robotics to High School students: 11 April, *Escola E.B. 2, 3 de D. Pedro IV - Queluz*

Pedro Lima made presentations and demonstrations on Robotics to High School students: 29 May, *CINEL - Amadora*

3.5.3 PARTICIPATIONS

During 2003 ISR-Lisbon researchers participated in the following International conferences, workshops and meetings:

Iberian Conference on Pattern Recognition and Image Analysis, Maiorca, June 2003.

13th IFAC Symposium on System Identification, Rotterdam, June 2003.

IEEE Int. Conf. Image Processing, Barcelona, September 2003.

Energy Minimization Methods in Computer Vision and Pattern Recognition, IAPR, Lisbon, July 2003.

IEEE Workshop on Multi-Object Tracking, Madison, June, 2003.

International Workshop on Energy Minimization Methods in Computer Vision and Pattern Recognition, EMMCVPR'03, Lisbon, Portugal, July, 2003.

IEEE International Conference on Acoustics, Speech and Signal Processing ICASSP 2003, Hong-Kong.

IV IEEE International Workshop on Signal Processing Advances in Wireless Communications, Rome, June 2003.

4th Conference on Telecommunications (ConfTele'2003), Aveiro, Portugal, June 2003.

11th Mediterranean Conference on Control and Automation, Greece, June 2003

1^o Congresso Nacional da Administração Pública, Lisbon, November 2003

IEEE 11th International Conference on Advanced Robotics – ICAR03, Coimbra, Portugal, June 2003.

6th Meeting of the Electric Engineering Section of the Portuguese Ordem dos Engenheiros, Lisbon, May de 2003.

3rd Portuguese Robotics Festival, Lisbon, May 2003.

EURON annual meeting, Lisbon, Portugal, January 2003.

7th IFAC Symposium on Robot Control, SYROCO 2003, Wroclaw, Poland, September 2003.

9th IEEE International Conference on Methods and Models in Automation and Robotics, MMMAR2003, Miedzyzdroje, Poland, August 2003.

The Mobile Robotics Laboratory presented some of its Lego robots in the X Informatics Week, an initiative of the students of the undergraduate course on Informatic Engineering and Computer Science, March 2003.

IFAC GCUV Newport, UK, April 2003.

ICAR 2003, Coimbra, Portugal, June-July 2003.

IFAC MCMC2003, Girona, Spain, September 2003.

IEEE CDC03, Hawaii, December 2003.

ECC03, Cambridge, UK, September 2003.

AIAA GNC Conference, Texas, USA, August 2003.

MED'2003, Rhodes, Greece, June 2003.

3.6 SERVICE ACTIVITIES

This section is dedicated to service activities developed, during 2003, by ISR-Lisbon researchers as members of the national and international scientific community.

3.6.1 EDITORIAL BOARDS

M. Isabel Ribeiro - member of the team that, under the framework of EURON, was responsible for the launching of the RoboticsWEBook. Development of the guidelines for contributions, list of topics, policies and contents.

Paulo Gonçalves - associate editor, IEEE Signal Processing Letters

Victor Barroso - associate editor, IEEE Signal Processing Letters

3.6.2 ADVISORY BOARDS

Agostinho Rosa - member of IASTED TC - Biomedical Engineering

Agostinho Rosa - member of IFAC TC - Optimal Control

António Pascoal - Member, Consulting Committee of the Strategic Commission for the Oceans, in charge of submitting to the Adjunct Minister of the Prime Minister of Portugal an integrated document that will serve as a road map for future activities - at a national scale - on a wide range of ocean related issues, including marine science and technology.

António Pascoal - Portuguese Representative to EurOcean: an Internet Portal for Marine Science and Technology in Europe, FCT, Lisbon, Portugal.

João José dos Santos Sentieiro - member of the European Space Agency (ESA) Advisory Group on Robotics and Automation.

José Santos-Victor - member of the Aurora Board of Participants of the European Space Agency (ESA).

Victor Barroso - chair of the IEEE Signal Processing Society in the steering committee of the IEEE Transactions on Mobile Computing.

Victor Barroso - chair of the IEEE Portugal Chapter on Signal Processing.

3.6.3 PROGRAMME AND TECHNICAL COMMITTEES

Agostinho Rosa - ACM SAC' 03 - Evolutionary Computation and Optimization, Melbourne, EUA.

Agostinho Rosa - APS 2003 - Congresso da Associação Portuguesa de Sono - Ponta Delgada.

Agostinho Rosa - BioEng 2003 - SPEB, Lisboa, Portugal, 2003.

Agostinho Rosa - BIOMED 2003 - IASTED – Int Conference on Biomedical Engineering – Salzburg.

Agostinho Rosa - ETFA 2003 – 9th IEEE International conference on Emerging Technologies and Factory Automation, Lisboa.

Agostinho Rosa - ICEIS 2003 – Artificial Intelligence - Angers, França.

Agostinho Rosa - ICONS 2003 - IFAC – Intelligent Control and Signal Processing – Faro, Portugal.

António Pascoal - Member, International Federation of Automatic Control (IFAC) Technical Committee on Marine Applications.

António Pascoal - Member, International Federation of Automatic Control (IFAC) Technical Committee on Intelligent Autonomous Vehicles.

António Pascoal - Member, International Program Committee, 11th IEEE Mediterranean Conference on Control and Automation, Rhodes, Greece.

António Pascoal - Member, International Program Committee, 1st IFAC Workshop on Guidance and Control of Underwater Vehicles, Newport, UK.

António Pascoal - Member, International Program Committee, 2003 IEEE International Symposium on Intelligent Control, ISIC'03, Houston, Texas.

António Pascoal - Member, International Program Committee, 6th IFAC Conference on Manoeuvring and Control of Marine Craft (MCMC2003), Girona, Spain.

António Pascoal - Member, International Program Committee, IEEE Conference on Intelligent Robots and Systems, IROS'03, Las Vegas.

Isabel Lourtie - Associated member of the IEEE Sensor Array and Multichannel Technical Committee.

João Gomes - Treasurer and Member of the technical committee of the 2004 IEEE Workshop on Signal Processing Advances in Wireless Communications (SPAWC'2004)

Jorge S. Marques - member of the Technical Committee of CIARP'03 Congreso Iberoamericano de Reconocimiento de Padrones, Habana, November 2003.

Jorge S. Marques - member of the Technical Committee of ECPG'03, Encontro Português de Computação Gráfica, Porto, October 2003.

Jorge S. Marques - member of the Technical Committee of the Workshop on Pattern Recognition in Information Systems, 2003.

José Santos-Victor – Co-Chair and Member of the Programme Committee of the IEEE Workshop on Omnidirectional-Vision, Madison, Wisconsin, June 2003.

José Santos-Victor – Member of the Programme Committee ETFA'2003 (Emerging Technologies in Factory Automation, Lisbon, September 2003.

Luis Custódio - 3rd Festival Nacional de Robótica – Robótica 2003, May 2003.

Luis Custódio - 9th Iberoamerican Conference on Artificial Intelligence, IBERAMIA 2004, November 2004.

Luis Custódio - International Conference on Informatics in Control, Automation and Robotics, Agosto 2004.

Luis Custódio - member of the Technical-Scientific Committee of the Portuguese Robotics Open (*Festival Nacional de Robótica*)

Luis Custódio - Third International Symposium "Affective Computational Entities", 17th European Meeting on Cybernetics and Systems Research (EMCSR'04), April 2004.

M. Isabel Ribeiro - General Chair and Chair of the International Program Committee of the 5th IFAC Symposium on Intelligent Vehicles, IAV2004, Lisbon, 5-7 July 2004.

M. Isabel Ribeiro - Member of the International Program Committee of the 8th Conference on Intelligent Autonomous Systems - IAS8, Amsterdam, Netherlands, March 2004.

M. Isabel Ribeiro - Member of the International Program Committee of the 11th IEEE International Conference on Advanced Robotics, ICAR 2003, Coimbra, Portugal, July 2003.

M. Isabel Ribeiro - Member of the Organizing Committee, in charge of the Scientific Meeting, of the 3rd National Festival of Robotics, Lisbon, Portugal, May 2003.

M. Isabel Ribeiro - Member of the Program Committee of the 12^o Encontro Português de Computação Gráfica, October 2003, Porto, Portugal.

M. Isabel Ribeiro - Member of the Program Committee of Track 8 (Intelligent Robotics and Systems) of the 9th IEEE International Conference on Emerging Technologies and Factory Automation, ETFA2003, Lisbon, September 2003.

M. Isabel Ribeiro - vice-chair of the IFAC Technical Committee on Intelligent Autonomous Vehicles.

Paulo Gonçalves - Director of Wavelet And Multifractal Analysis summer school, Cargese (Fr), July 19-31, 2004.

Paulo Oliveira - Member of the Jury and Scientific Committee of the "2003 National Robotics Meeting," Lisbon, May 2003.

Pedro Lima - 11th International Conference on Advanced Robotics, ICAR 2003, Coimbra, June-July 2003.

Pedro Lima - 2003 IEEE CSS Int. Conf. on Control Applications, Istanbul, 23-25 June 2003.

Pedro Lima - 2nd International Joint Conference on Autonomous Agents and Multi-Agent Systems 2003, AAMAS 2003, Melbourne, Australia, July 2003.

Pedro Lima - 3rd Festival Nacional de Robótica - Robótica 2003, May 2003.

Pedro Lima - 5th IFAC Symposium on Intelligent Autonomous Vehicles (IAV 2004), Lisbon, Portugal, 5-7 July 2004.

Pedro Lima - 8th Conference on Intelligent Autonomous Systems, Amsterdam, the Netherlands, 10-13 March 2004.

Pedro Lima - IASTED International Conference on Modelling, Identification and Control (MIC 2004), Grindelwald, Switzerland, February 22-25, 2004.

Pedro Lima - IEEE/RSJ Conference on Intelligent Robotics Systems, IROS 2003, Las Vegas, Nevada, USA, October.

Pedro Lima - member of the Editorial Board of the Portuguese *Robótica* magazine.

Pedro Lima - member of the Technical-Scientific Committee of the Portuguese Robotics Open (*Festival Nacional de Robótica*).

Pedro Lima - Trustee of the RoboCup Federation.

Pedro M.Q. Aguiar - Member of the Program Committee of the International Workshop on Energy Minimization Methods in Computer Vision and Pattern Recognition, EMMCVPR'03, Lisboa, Portugal, July, 2003.

Sérgio M. Jesus - Int. Conf. on Theoretical and Computational Acoustics, Honolulu, Hawaii (USA), August.

Victor Barroso - General Chair of the 2004 IEEE Workshop on Signal Processing Advances in Wireless Communications (SPAWC'2004).

Victor Barroso - member of the IEEE Sensor Array and Multichannel Technical Committee.

3.6.4 CHAIRPERSON

Agostinho Rosa - BioEng 2003, 26 de Junho de 2003 - Lisboa, Portugal.

António Pascoal - Session, 1st IFAC Workshop on Guidance and Control of Underwater Vehicles, Newport, UK.

António Pascoal - Session, 6th IFAC Conference on Manoeuvring and Control of Marine Craft (MCMC2003), Girona, Spain.

Carlos Bispo - Co-chair on a session of the 11th Mediterranean Conference on Control and Automation, Greece, June 2003.

Jorge S. Marques - IbPRIA'03, Iberian Conference on Pattern Recognition and Image Analysis, Maiorca, June 2003.

José Santos-Victor - International Conference on Robotics and Automation, ICAR, Coimbra, May 2003. Session on Vision.

M. Isabel Ribeiro - Chair of sessions "Localization" and "Mobile Robots" on IEEE 11th International Conference on Advanced Robotics - ICAR03, Coimbra, Portugal, June 2003.

M. Isabel Ribeiro - Chair of the session on "Control and Computer Systems" on the 6th Electrical Engineering Meeting of the Portuguese Ordem dos Engenheiros, Lisbon, May 2003.

Pedro Lima - 3rd Festival Nacional de Robótica - Robótica 2003, May 2003.

Pedro Lima - 11th International Conference on Advanced Robotics, ICAR 2003, Coimbra, June-July 2003.

Pedro M.Q. Aguiar - Chair of the Session "Segmentation and Grouping" of the International Workshop on Energy Minimization Methods in Computer Vision and Pattern Recognition, EMMCVPR'03, Lisboa, Portugal, July, 2003.

Sérgio M. Jesus - Int. Conf. on Theoretical and Computational Acoustics, Honolulu, Hawaii (USA), August.

3.6.5 REVIEWERS

Jorge S. Marques - Pattern Recognition Letters, Elsevier.

Jorge S. Marques - IbPRIA'03, Iberian Conference on Pattern Recognition and Image Analysis, Maiorca, June 2003.

Pedro M. Q. Aguiar - IEEE International Conference on Image Processing - ICIP'03, Barcelona, Spain, September 2003

Pedro M. Q. Aguiar - IEEE Signal Processing Letters

Pedro M. Q. Aguiar - IEEE Transaction on Signal Processing

Pedro M. Q. Aguiar - International Workshop on Energy Minimization Methods in Computer Vision and Pattern Recognition, EMMCVPR'03, Lisboa, Portugal, July, 2003

Pedro M. Q. Aguiar - IEEE International Conference on Computer Vision and Pattern Recognition, CVPR'04.

Isabel M. G. Lourtie - IEEE Signal Processing Letters

Francisco Garcia - IEEE Signal Processing Letters

Francisco Garcia - IEEE Transactions on Signal Processing

João Xavier - IEEE Transactions on Signal Processing

Pierre Borgnat - IEEE Signal Processing Letters.

Pierre Borgnat - IEEE Transactions on Signal Processing

Paulo Gonçalves - Traitement du Signal

Paulo Gonçalves - IEEE Signal Processing Letters

Paulo Gonçalves - Int. J. on Wavelets Multiresolution and Info. Processing

Paulo Gonçalves - IEEE Trans. on Info Theory

Paulo Gonçalves - Signal Processing (Elsevier), Eusipco 2004.

João Gomes - IEEE Transactions on Signal Processing

João Gomes - IEEE Signal Processing Letters

João Gomes - IEEE Transactions on Multimedia

João Gomes - IEEE Journal of Oceanic Engineering

João Gomes - IEEE International Conference on Acoustics, Speech and Signal Processing (ICASSP'2004)

João Gomes - 2004 American Control Conference (ACC'2004)

Carlos Bispo - 11th International Conference in Advanced Robotics

Carlos Bispo - 11th Mediterranean Conference on Control and Automation

M. Isabel Ribeiro - *IEEE Robotics & Automation Magazine* - special issue on "Industrial Robotics Applications & Industry Academia Cooperation in Europe", July 2003.

M. Isabel Ribeiro - ROBÓTICA 2003 - 3rd Portuguese Robotics Festival, Lisbon, Portugal, May 2003.

M. Isabel Ribeiro - *Ingenium*, journal of the Portuguese Association of Engineers, 2003.

M. Isabel Ribeiro - IAS8 -8th Conference on Intelligent Autonomous Systems, Amsterdam, Netherlands, March 2004.

M. Isabel Ribeiro - ISIC03 – 18th IEEE International Symposium on Intelligent Control – 2003

M. Isabel Ribeiro - MED2003 – 11th Mediterranean Conference on Control and Automation – 2003

M. Isabel Ribeiro - ICAR 2003 – 11th IEEE International Conference on Advanced Robotics – 2003

M. Isabel Ribeiro - ECC 2003 – European Control Conference - 2003

João Sequeira - 2003 IEEE International Symposium on Intelligent Control

João Sequeira - IEEE 11th International Conference on Advanced Robotics(ICAR 2003) University of Coimbra, Portugal: 30 June-3 July 2003

João Sequeira - European Control Conference ECC2003

Pedro Lima - IEEE Transactions on Systems, Man and Cybernetics – Part B

Pedro Lima - IEEE Transactions on Systems, Man and Cybernetics – Part C

Pedro Lima - Journal of Intelligent and Fuzzy Systems

Pedro Lima - IEEE Conference on Decision and Control 2003, Maui, HI, December

Pedro Lima - IEEE ISIE 2003

Pedro Lima - 2003 IEEE CSS Int. Conf. on Control Applications, Istanbul, 23-25 June

Pedro Lima - 2nd International Joint Conference on Autonomous Agents and Multi-Agent Systems 2003, AAMAS 2003, Melbourne, Australia, July 2003

Pedro Lima - IEEE/RSJ Intelligent Robotics Systems, IROS 2003,

Pedro Lima - IASTED International Conference on Modelling, Identification and Control (MIC 2004), Grindelwald, Switzerland, February 22-25, 2004

Pedro Lima - 8th Conference on Intelligent Autonomous Systems, Amsterdam, the Netherlands,10-13 March 2004

Pedro Lima - American Control Conference 2004, Boston, MA, USA, June 2004

Luis Custódio - 8th Conference on Intelligent Autonomous Systems, Amsterdam, the Netherlands,10-13 March 2004.

José Santos-Victor - IEEE Transactions on Pattern analysis and Machine Inteligence

José Santos-Victor - IEEE Transactions on Robotics and Automation

José Santos-Victor - IEEE Transactions on Biomedical Engineering

José Santos-Victor - IEEE Transactions on Robotics and Automation

José Santos-Victor - Journal of Real-Time Imaging

José Santos-Victor - Journal of Robotics and Autonomous systems

Sérgio M. Jesus - Journal of Acoustical Society of America

Sérgio M. Jesus - IEEE Journal of Oceanic Engineering

Sérgio M. Jesus - ICASSP'04

Agostinho Rosa - Reviewer of IEEE Transaction of Circuits and Systems for Video Technology.

Agostinho Rosa - Reviewer of IEEE Transaction of Biomedical Engineering.

Agostinho Rosa - Reviewer of Clinical Neurophysiology.

Agostinho Rosa - Reviewer of International Journal of Imaging and Graphics.

António Pascoal - IFAC Control Engineering Practice.

António Pascoal - IEEE Journal of Oceanic Engineering.

António Pascoal - International Journal of Robust and Nonlinear Control

António Pascoal - Automatica

António Pascoal - IEEE Transactions on Robotics and Automation

António Pascoal - 11th Mediterranean Conference on Control and Automation - MED'2003, Rhodes, Greece,

António Pascoal - 18th IEEE International Symposium on Intelligent Control (ISIC'03).

António Pascoal - Automatic Control Conference, ACC 2003.

António Pascoal - IEEE Conference on Intelligent Robots and Systems - IROS'03, Las Vegas.

António Pascoal - IFAC Workshop on Guidance and Control of Underwater Vehicles, Newport, South Wales, UK

António Pascoal - 6th IFAC Conference on Manoeuvring and Control of Marine Craft (MCMC2003), Girona, Spain.

Paulo Oliveira - 18th IEEE International Symposium on Intelligent Control (ISIC'03), October 2003

Carlos Silvestre - International Conference on Emerging Technologies and Factory Automation, ETFA'2003

3.6.6 OTHER ACTIVITIES

João Sentieiro - Secretary of the Associate Laboratory Council

João Sentieiro - Member of the High Council for Science, Technology and Innovation

João Sentieiro - Member of the Social and Economic Council

Pedro M. Q. Aguiar - member of the Scientific Committee of the IST ECE Graduate Education -- coordinator of the Systems, Decision, and Control area.

Francisco Garcia - member of the Executive Board of IST's Dept. of Electrical and Computer Engineering

Victor Barroso - Vice-President of the Executive Board of IST'Scientific Council

João Xavier - Member of the National Science Foundation international evaluation committee of Signal Processing in Communications project proposals, February 2003

José Santos-Victor – Evaluator of EU- Future Emerging Technologies (FET) R&D Project Proposals.

Agostinho Rosa – Evaluation and Review expert for EU information Society and Technology Program – PE – TC

Agostinho Rosa – Juri para atribuição do Prémio Investigação do Sono Sanofi_Synthelabo – Sociedade Brasileira do Sono.

António Pascoal - Expert Evaluator, in charge of evaluating proposals related to the "Support for Research Infrastructures" Action of the 6th Framework Programme of the EU, 2003.

António Pascoal - Member, Workgroup on *Research Vessels* of the Intersectorial Oceanographic Mission / Ministry of Science and Technology, Portugal. Objective of the Workgroup: to assess the state of the scientific fleet and to define guidelines for its expansion and efficient utilization by the scientific community at large.

António Pascoal - Member, Workgroup on *Deep Sea Research* of the Intersectorial Oceanographic Mission / FCT, Portugal. Objective of the Workgroup: to foster the development of deep sea marine science and technologies.

Isabel Ribeiro - Adjoint Director for Project Management, IST.

3.7 ACADEMIC ACTIVITIES

Here we list the participation, during 2003, of ISR-Lisbon (ECE) researchers in committees for Master and Doctoral Thesis, and other academic related activities.

Victor Barroso - Doctoral Thesis committee, Francisco Alberto Sena da Silva, Importance Sampling Evaluation of Digital Phase Detectors with Carrier Phase Tracking, Instituto Superior Técnico, 2003.

Victor Barroso - Member of the MSc thesis committee of Tiago Patrão, "Tracking a Mobile Binary Source in Wireless Systems with Spatial Diversity", Instituto Superior Técnico, Universidade Técnica de Lisboa, December 2003.

Jorge S. Marques - Doctoral Thesis committee, Tiago Afonso Sepúlveda, Optimização de Sistemas de Classificação através de Evolução, Instituto Superior Técnico, 2003.

Jorge S. Marques - Doctoral Thesis committee, João Sanches, Reconstrução 3D Bayesiana a partir de Sequências Ecográficas, Instituto Superior Técnico, Março 2003.

Jorge S. Marques - Doctoral Thesis committee, Fernando Augusto Sereno, Regressão com Redes Neurais e Máquinas de Vectores de Suporte Aplicada à Estimação do Peso Fetal, FEUP, July 2003.

Jorge S. Marques - Doctoral Thesis committee, Jacinto Nascimento, Robust Shape Estimation and Tracking in the Presence of Clutter, Instituto Superior Técnico, April 2003.

Isabel Lourtie - Doctoral Thesis committee, Francisco Alberto Sena da Silva, Importance Sampling Evaluation of Digital Phase Detectors with Carrier Phase Tracking, Instituto Superior Técnico, July 2003.

Jorge S. Marques - M.Sc. Thesis committee, Maria Luisa Bastos, Optimização da Determinação de Correspondências entre Objectos Deformáveis no Espaço Modal, Faculdade de Ciências da Universidade do Porto, 2003.

Jorge S. Marques - M.Sc. Thesis committee, Tiago Araújo Silva, Interferometria de Imagens de Radar de Abertura Sintética, Instituto Superior Técnico, September 2003.

João Xavier - Member of the MSc thesis committee of Tiago Patrão, "Tracking a Mobile Binary Source in Wireless Systems with Spatial Diversity", Instituto Superior Técnico, Universidade Técnica de Lisboa, December 2003.

M. Isabel Ribeiro - member of the PhD jury of Cristina Manuela Peixoto Santos, that submitted the thesis "Attractor Dynamics Based on Generation of Timed Robotic Trajectory", University of Minho, November 2003. Main external examiner.

M. Isabel Ribeiro - member of the Ph.D. jury of José António da Cruz Pinto Gaspar, that submitted the thesis " Omnidirectional Vision for Mobile Robot Navigation", Instituto Superior Técnico, May 2003.

M. Isabel Ribeiro - member of the Ph.D. jury of Rui Pedro Duarte Cortesão, that submitted the thesis " Kalman Techniques for Intelligent Control Systems: Theory and Robotic Experiments ", University of Coimbra, January 2003.

M. Isabel Ribeiro - member of the M.Sc. jury of Caetano Filipe Costa de Noronha Ferreira, that submitted the thesis " Utilização de padrões de medidas laser para localização de um robot móvel", University of Aveiro, January 2003. External examiner.

João Sequeira - member of the M.Sc. jury of Sérgio Luís Proença Duarte Guerreiro, that submitted the thesis "Reorganização Dinâmica de Processos Face a Situações de Crise: Aplicação em Exemplos Robóticos e Empresariais Simplificados", Instituto Superior Técnico, 2003

M. Isabel Ribeiro - Vice-Director of the Institute for Systems and Robotics / Lisbon pole.

M. Isabel Ribeiro – IST Adjoint Director for Project Management.

João Paulo Costeira – Member of the PhD Thesis Committee of Nuno Ricardo Gracias, Instituto Superior Técnico, June 2003.

João Sentieiro – Member of the PhD Thesis Committee of José António Gaspar, Instituto Superior Técnico, May 2003.

João Sentieiro – Member of the PhD Thesis Committee of Nuno Ricardo Gracias, Instituto Superior Técnico, June 2003.

José Santos-Victor – Member of the PhD Thesis Committee of Jacinto Carlos Nascimento, Instituto Superior Técnico, April 2003.

José Santos-Victor – Member of the PhD Thesis Committee of José António Gaspar, Instituto Superior Técnico, May 2003.

José Santos-Victor – Member of the PhD Thesis Committee of Nuno Ricardo Gracias, Instituto Superior Técnico, June 2003.

José Santos-Victor – Member of the PhD Thesis Committee of Paulo José Monteiro Peixoto, Faculdade de Ciências e Tecnologia, Universidade de Coimbra, November 2003.

José Santos-Victor – Member of the PhD Thesis Committee of Roland Bunschoten, Informatics Institute, Faculty of Science, University of Amsterdam, November 2003.

José Santos-Victor – Member of the PhD Thesis Qualify Committee of Raquel Frizzera Vassalo, Universidade Federal de Espírito Santo, Brasil, March 2003.

Luis Custódio – member of Coordination Committee of the Electrical and Computer Engineering (LEEC) undergraduated degree, at IST. Coordinator of the LEEC's branch on Systems, Decision and Control.

Luis Custódio – advisor of the Post-Doc Sandra Gadanho, PhD in Artificial Intelligence, University of Edinburgh, Scotland, from March 2001 to February 2003.

Pedro Lima – Member of the PhD Thesis Committee of José António Gaspar, Instituto Superior Técnico, May 2003.

Pedro Lima – member of the Doctoral Thesis committee of Vladimir Gligic, *Universidade da Beira Interior* (degree equivalence)

Pedro Lima – member of the Master Thesis committee of Sérgio Figueiredo , Instituto Superior Técnico , 2003

Pedro Lima – member of the Master Thesis committee of Márcia Maçãs , Instituto Superior Técnico , 2003

Pedro Lima – member of the Master Thesis committee of Rodolfo Oliveira , Instituto Superior Técnico , 2003

Pedro Lima – reviewer of PhD Thesis of Javier Minguez, University of Zaragoza, Spain

Luis Custódio – member of the Master Thesis committee of Márcia Maçãs, Instituto Superior Técnico , 2003

Luis Custódio – member of the Master Thesis committee of Pedro Vale, Instituto Superior Técnico , 2003

Luis Custódio – member of the Master Thesis committee of João Paulo Caldeira, Instituto Superior Técnico , 2003

Agostinho Rosa – Júri da Prova de Doutoramento em Engenharia Electrotécnica e de Computadores do Lic^o Tito Silva. O tema da tese: "Representação, reconhecimento e reconstrução não supervisionado de objectos em imagens", prevista para 16 de Maio de 2003.

Agostinho Rosa – Júri da Prova de Doutoramento em Engenharia Electrotécnica e de Computadores do Mestre Tiago Afonso Fernandes Sepúlveda. O tema da tese: "Optimização de Sistemas de Classificação através da Evolução", Março de 2003.

Agostinho Rosa – Júri da Prova de Mestrado do Lic^a. Cecília Maria Fernandes Fonseca em Investigação Operacional, Faculdade de Ciências da Universidade de Lisboa. O tema da tese: "Parametrização de Algoritmos Evolutivos", 2003

Agostinho Rosa – Júri e arguente de dissertação do Concurso para Professor Coordenador na área de Engenharias de Sistemas e Automação Industrial do ISEL, 8-9 de Julho de 2003.

Agostinho Rosa – Júri da Prova de Mestrado do Lic^o. João Paulo Caldeira em Engenharia Electrotécnica e de Computadores. O tema da tese: "Aplicação de Algoritmos Híbridos na Solução do Problema de JobShop", 14 de Outubro de 2003.

Paulo Oliveira - Member of the PhD Thesis Committee of Nuno Gracias: "Mosaic-based Visual Navigation for Autonomous Underwater Vehicles," IST, June 2003.

Carlos Silvestre – Member of the Msc Thesis Committee of Luis Bruno: "Virtual Environment for the Simulation of a Crane Operation in a Marble Quarry," Department of Informatics, Instituto Superior Tecnico, Lisbon, Portugal.

António Pascoal – Member of the PhD Thesis Committee of Karl-Petter Lindegaard: "Acceleration Feedback in Dynamic Positioning Systems," Department of Engineering Cybernetics, Norwegian University of Science and Technology (NTNU), Trondheim, Norway, 24 September 2003.

3.8 DISTINGUISHED VISITORS

Prof. Shariar Negahdaripour, University of South Florida, Miami, USA.

Prof. Kostas Daniilidis, University of Pennsylvania, USA.

Prof. Emanuele Trucco, Heriot-Watt University, UK.

Prof. Nicolas Franceschini, Research Director CNRS, F.

Dr. Alonzo Kelly, Robotics Institute, Carnegie Mellon University, USA.

Minoru Asada, President of the RoboCup Federation, Japan

Paolo Petta, Austrian Research Inst. for Artificial Intelligence, Austrian

Dag Tollefsen, Norwegian Defence Res. Establishment, Norway

Dr. Elgar de Sa –National Institute of Oceanography (NIO), Dona Paula, Goa,

Dr. Prabhu Desai –National Institute of Oceanography (NIO), Dona Paula, Goa

Dr. Massimo Caccia –Istituto Automazione Navale, CNR, Genova, Italy

Marcus Cardew – System Technologies

3.9 SPECIAL EVENTS

3.9.1 ROBÓTICA 2003 – 3rd PORTUGUESE ROBOTICS OPEN (FESTIVAL NACIONAL DE ROBÓTICA)

FIL, Lisboa, Portugal
May 8 – may 11, 2003

Coordinators: Carlos Carneira, Luis Custódio, Pedro Lima, M. Isabel Ribeiro, João Sousa

Laboratories: Intelligent Systems Lab, Mobile Robotics Lab

Support: Lisaction, Agência Nacional para a Cultura Científica e Tecnológica – Ciência Viva, Fundação para a Ciência e a Tecnologia (FCT), Fundação Luso-Americana para o Desenvolvimento (FLAD), AERLIS, Revista ROBÓTICA, Ordem dos Engenheiros, Caixa Geral de Depósitos, Turismo de Lisboa, Ideias Claras

Description: The event consisted of 5 Robotic competitions for Universities and High-Schools, and a Symposium with technical presentations. A record number of 90 teams and about 500 participants was reached this year.

URL: <http://Robotica2003.ist.utl.pt/>

3.9.2 CONSTRUÇÃO DE UM ROBOT FUTEBOLISTA

Instituto Superior Técnico, Lisboa, Portugal
September 8 – September 12, 2003

Program: Ocupação Científica de Jovens nas Férias 2002

Coordinator: Pedro Lima

Laboratories: Intelligent Systems Laboratory

Support: Agência Nacional para a Cultura Científica e Tecnológica – Ciência Viva

Description: This was a workshop for High School students aiming at motivating them for the learning of Science and Technology, namely Robotics. The students had to build from an initial kit a team of two robots capable of playing football according to the rules of RoboCup Junior. In the process, they learned from several disciplines such as math, electronics, programming and mechanics, among others. In the end, the available teams played in a round-robin tournament. The workshop had the participation of 24 students from 13 schools.

URL: <http://lci.isr.ist.utl.pt/projects/educational/cvnasferias/index2003.html>

3.9.3 1st ISlab WORKSHOP

Instituto Superior Técnico, Lisboa, Portugal
February 23th , 2003

Coordinator: Pedro Lima

Laboratories: Intelligent Systems Laboratory

Description: This was a workshop organized by the Intelligent Systems Lab. aiming at the presentation for all the group of the research work being developed by its members, mainly the PhD and MSc stidents.

URL: <http://islab.isr.ist.utl.pt/htdocs/islabwks1.htm>

3.9.4 2nd ISlab WORKSHOP

Instituto Superior Técnico, Lisboa, Portugal
February 23th , 2003

Coordinator: Luis Custódio

Laboratories: Intelligent Systems Laboratory

Description: This was a workshop organized by the Intelligent Systems Lab. aiming at the presentation for all the group of the research work being developed by its members, mainly the PhD and MSc stidents.

URL: http://islab.isr.ist.utl.pt/htdocs/2nd_ISlab_Workshop.htm

3.9.5 MARITIME RAPID ENVIRONMENTAL ASSESSMENT'03 SEA TRIAL

Coast of Italy, Italy
June 18 - June 26 , 2003

Field experiment: participation in the Maritime Rapid Environmental Assessment'03 sea trial, organized by the NATO Undersea Research Centre (NURC), La Spezia (ITALY), from 18-26 June, 2003, off the west coast of Italy, north of Elba I. This participation is made under the AOB-Joint Research Project involving SiPLAB, NURC, ULB (Belgium) and RNLNC (The Netherlands).

3.9.6 INFANTE SEA TRIAL

**INFANTE SEA TRIALS
Faial Island, Azores, Portugal
July 24 - August 15, 2003**

During a period of approximately 22 days, the DSORL of ISR carried out missions with the INFANTE autonomous underwater vehicle (AUV) and the ÁGUAS VIVAS Research Vessel at sea, in the Azores, in cooperation with the IMAR/DOP/Univ. Azores in the scope of the MAROV project. In the course of the mission, bathymetric data were acquired (that complements that obtained in 2002) with the objective of obtaining accurate maps of the seabed near Faial Islands, and in particular in the Pico Channel. The INFANTE AUV was again operated in a fully autonomous mode and carried out transects in the canal between the islands of Faial and Pico, at varying depths, under the supervision of its on-board resident Mission Control System. The AUV was equipped with an array of sensor suites that included an attitude unit, an echosounder, a Plankton Sampler, a Fluorometer, and a CTD. Acoustic communications tests were also carried out with two different kinds of equipment. The mission provided an excellent opportunity to bring together marine scientists and system designers. Visitors from India, Italy, and the UK had the opportunity to witness the operation of the INFANTE AUV.

3.9.7 PARTICIPATION IN THE EXHIBIT “ENGENHO E OBRA”

**Participation in the Exhibit
“ENGENHO E OBRA”**

Jan. 8 - March 2, 2003

During the exhibit, full scale models of the INFANTE AUV and the DELFIMx ASC were on display, together with a video illustrating the development and operation of autonomous marine vehicles at sea. The activities carried out at the ISR were further disseminated through a video that was prepared by the exhibit organization and shown on a national TV Channel.



The INFANTE AUV and the DELFIMx ASC at the Exhibit
“Engenho e Obra” , Cordoaria Nacional, Lisboa, 2003

3.10 AWARDS

Best Poster Award of Intelligent Autonomous Systems IAS-8, Amsterdam, The Netherlands, March 2004:
"Bayesian Sensor Fusion for Cooperative Object Localization", **Pedro Pinheiro** e **Pedro Lima**.

2003 IBM Science Prize, **João Xavier**.

3.11 PUBLICATIONS

A) M.Sc. THESES (6):

- [1] **Rodolfo Oliveira**, "Supervision and Mission Control of Autonomous Vehicles," Instituto Superior Técnico, October, 2003, Portugal.
- [2] **Sérgio Luís Proença Duarte Guerreiro** , "Reorganização Dinâmica de Processos Face a Situações de Crise: Aplicação em Exemplos Robóticos e Empresariais Simplificados", Tese de Mestrado, Instituto Superior Técnico, 2003.
- [3] **Tiago Patrão**, "Tracking a Mobile Binary Source in Wireless Systems with Spatial Diversity", Instituto Superior Técnico, Universidade Técnica de Lisboa, December 2003.
- [4] **João Paulo Caldeira**, "Evolutionary Taboo Search Algorithm in Jobshop Scheduling" , Oct 2003, Instituto Superior Técnico, Lisboa, Portugal.
- [5] **Marcia Maças** - "Sociedade de Agentes Autónomos Aplicação de uma Arquitectura baseada em Emoções", Instituto Superior Técnico, April 2003.
- [6] **Pedro Vale**, - "Aprendizagem num Agente Baseado em Emoções: Aplicação de Aprendizagem por Reforço", Instituto Superior Técnico, April 2003.

B) Ph.D. THESES (6):

- [7] **João Raposo Sanches**, "3D Bayesian Reconstruction from Ultrasound Sequences", Instituto Superior Técnico, March 2003.
- [8] **Jacinto Nascimento**, "Robust Shape Estimation and Tracking in the Presence of Clutter", Instituto Superior Técnico, April 2003, Portugal.
- [9] **Nuno Gracias** - Mosaic-based Visual Navigation for Autonomous Underwater Vehicles, , Ph.D. Thesis, June 2003.
- [10] **José Gaspar** - Omnidirectional Vision for Mobile Robot Navigation, , Ph.D. Thesis, May 2003.
- [11] **Tito Livio Silva** - Representação e Reconhecimento de Objectos Visuais - April 2003, Instituto Superior Tecnico - Lisbon - Portugal
- [12] **Raquel Frizzera Vassalo** - "Motor Representations for Topological Navigation and Ego-Motion based on Omnidirectional Images", " Ph.D. Thesis March 2003, Vitória, Espírito Santo, Brasil.

C) IN BOOKS (3):

- [13] **B. Damas, L. Custódio, P. Lima**, "A Modified Potential Fields Method for Robot Navigation Applied to Dribbling in Robotic Soccer", *RoboCup 2002 Book*, Editors: Gal Kaminka, Pedro Lima and Raul Rojas, Springer-Verlag, Berlin, 2003.

- [14] **Paulo M. Oliveira, Victor A. N. Barroso**, "Uncertainty in Time-Frequency Analysis," invited article in the chapter Time-Frequency Signal and System Analysis, in *Time-Frequency Signal Analysis and Processing, Part II: Fundamental Principles of TFSAP*, Ed. B. Boashash, Elsevier, 2003.
- [15] **HongFei Gong, Agostinho Cláudio da Rosa**. Simulation Model for the Control of Olive Fly *bactrocera Oleae* Using Artificial Life Technique. In "Computacional Intelligence and Control", m Mohammadian, RA Sarker, Xin Yao (Edts), Chapter XI, pp 183-196, Idea Group Publishing, 2003. ISBN: 1-591-40-037-6, 2003.

D) IN INTERNATIONALS JOURNALS (25) :

- [16] **João Pina, Pedro Lima**, "A Glass Furnace Operation System Using Fuzzy Modelling and Genetic Algorithms for Performance Optimisation", *Engineering Applications of Artificial Intelligence*, Vol 16/7-8 pp 681-690, Elsevier 2003, 2003.
- [17] **Sandra Gadanho**, Learning Behavior-Selection by Emotions and Cognition in a Multi-Goal Robot Task, *Journal of Machine Learning Research*, JMLR 4(Jul):385-412, 2003.
- [18] **Márcia Maçãs, Luis Custódio**, Multiple Emotion-Based Agents using an Extension of DARE Architecture, *INFORMATICA, an International Journal of Computing and Informatics, Special Issue on Perception and Emotion Based Reasoning*, Vol. 27, pp. 185-195, 2003.
- [19] **Bruno Damas, Luis Custódio**, Emotion-Based Decision and Learning Using Associative Memory and Statistical Estimation, *INFORMATICA, an International Journal of Computing and Informatics, Special Issue on Perception and Emotion Based Reasoning*, Vol. 27, pp. 147-157, 2003.
- [20] **Sandra Gadanho, Luis Custódio**, Learning behavior-selection in a multi-goal robot task, *INFORMATICA, an International Journal of Computing and Informatics, Special Issue on Perception and Emotion Based Reasoning*, Vol. 27, pp. 175-183, 2003.
- [21] **Felisberto P., Lopes C., Carmo A., Jesus S.M. and Barbagelata A.**, "An autonomous system for ocean acoustic tomography", accepted to *Sea Technology*, October.
- [22] **CORRÉ V. and JESUS S.M.**, "Tracking of cold water upwelling filaments in the ocean using matched field inversion", *ACTA ACUSTICA united with ACUSTICA*, Vol.89, pp. 604-613, August.
- [23] **SOARES C. and JESUS S.**, "Broadband Matched-Field Processing: coherent vs. incoherent approaches", *Journal of Acoust. Soc. Am.*, vol. 113(5), pp. 2587-2598, May.
- [24] **L. M. B. C. Campos & P. G. T. A. Serrão**, "On helicoidal rectangular coordinates for the acoustics of bent and twisted tubes", *Wave Motion*, Volume 38, pages 53-66.
- [25] **L. M. B. C. Campos & N. L. Isaeva**, "On Alfvén waves in the solar breeze", *Physics of Plasmas*, Volume 10, pages 2486-2500.
- [26] **L. M. B. C. Campos & J. R. C. Azinheira**, "On the application of special functions to non-linear and unsteady stability, Part I: Method of interactive solution of coupled non-linear system", *Integral Transforms and Special Functions*, Volume 14, pages 149-166.
- [27] **L. M. B. C. Campos & J. R. C. Azinheira**, "On the application of special functions to non-linear and unsteady stability, Part II: Solution in terms of Bessel and hypergeometric functions". *Integral Transforms and Special Functions*, Volume 14, pages 167-180.
- [28] **L. M. B. C. Campos & J. M. G. S. Oliveira**. "On the optimization of non-uniform acoustic liners on annular nozzles", accepted for publication in *J. Sound Vib.* (available online).

- [29] **F. J. P. Lau & L. M. B. C. Campos**. "On the effect of wall undulations on the acoustics of ducts with flow", accepted for publication in *J. Sound Vib.*
- [30] **L. M. B. C. Campos & N. L. Isaeva**, "On the critical layer of Alfvén waves in the solar wind", *Journal of Plasma Physics* (to appear).
- [31] **L. M. B. C. Campos & J. M. G. Marques**, "On wake vortex response for all combinations of five classes of aircraft", *Aeronautical Journal* (to appear).
- [32] **João Sequeira, M. Isabel Ribeiro**, "Robot Team Control: a Geometric Approach" submitted for publication to *Robotics and Autonomous Systems*. Under review.
- [33] **Jacinto Nascimento, Jorge S. Marques**, An Adaptive Potential for Robust Shape Estimation, *Image and Vision Computing Journal*, 21,1107-1116, December, 2003.
- [34] **João M. Sanches, Jorge S. Marques**, Compensation of Log-Compressed Images for 3D Ultrasound, *Ultrasound in Medicine and Biology*, Vol. 29, No. 2, 247-261, February 2003.
- [35] **Jacinto Nascimento, Arnaldo J. Abrantes, Jorge S. Marques**, Using middle level features for robust shape tracking, *Pattern Recognition Letters*, Vol. 24, 295-307, January 2003.
- [36] **João M. Sanches, Jorge S. Marques**, Joint image registration and volume reconstruction for 3D ultrasound, *Pattern Recognition Letters, Special Issue on Ultrasonic Image Processing and Analysis*, vol 24, 791-800, February 2003.
- [37] **Pedro M. Q. Aguiar and José M. F. Moura**, Rank 1 Weighted Factorization for 3D Structure Recovery: Algorithms and Performance Analysis, *IEEE Transactions on Pattern Analysis and Machine Intelligence*, vol. 25, no. 9, September 2003.
- [38] **Cristina Videira Lopes and Pedro M. Q. Aguiar**, Acoustic Modems for Ubiquitous Computing, *IEEE Pervasive Computing Magazine*, vol. 2, no. 3, July-September 2003.
- [39] **Nuno Gracias, Sjoerd van der Zwaan, Alexandre Bernardino, José Santos-Victor** - Mosaic Based Navigation for Autonomous Underwater Vehicles, *IEEE Journal of Oceanic Engineering*, October 2003.
- [40] **João Maciel and João P. Costeira** - A Global Solution to Sparse Correspondence Problems, *IEEE Transactions on Pattern Analysis and Machine Intelligence*, Vol. 25 (2), February 2003.
- [41] **Christian Guilleminault, Dalva Poyares, Agostinho Rosa**. Cyclic Alternating Pattern and Fatigue. *Sleep*, S-1, 77, 2003

E) IN NATIONAL JOURNALS (1)

- [42] **Pedro Lima, João M. Sousa, M. Isabel Ribeiro, Carlos Carneira, Luis Custódio**, "Robótica 2003 - 3º Festival Nacional de Robótica", *Robótica*, artigo convidado, Julho de 2003.

F) IN INTERNATIONAL CONFERENCES (58)

- [43] **L. Silva, J. Santos, M. Neves, C. Silvestre, P. Oliveira, and A. Pascoal**, "Tools for the diagnosis and automated inspection of semi-submerged structures", *Proc. 13th International Harbour Congress*, Antwerpen, Belgium, March-April 2003.
- [44] **C. Silvestre and A. Pascoal**, "Control of the INFANTE AUV Using Gain Scheduled Static Output Feedback," *Proc. IFAC Workshop on Guidance and Control of Underwater Vehicles*, Newport, South Wales, UK, April 2003.

- [45] **L. Lapierre, D. Soetanto, and A. Pascoal**, "Nonlinear Path Following Control of Autonomous Underwater Vehicles," *Proc. IFAC Workshop on Guidance and Control of Underwater Vehicles*, Newport, South Wales, UK, April 2003.
- [46] **P. Oliveira and A. Pascoal**, "On the Design of Multirate Complementary Filters for Marine Vehicle Navigation: New Tools using Linear Matrix Inequalities (LMIs)," *Proc. IFAC Workshop on Guidance and Control of Underwater Vehicles*, Newport, South Wales, UK, April 2003.
- [47] **D. Labbé, P. Wilson, P. Weiss, L. Lapierre, and A. Pascoal**, "FREESUB Navigation, Guidance, and Control System for an Intervention AUV," *Proc. Thirteen Ship Control System Symposium (SCSS)*, Orlando, Florida, 7-9 April, 2003
- [48] **S. Fekri, M. Athans, and A. Pascoal**, "Identification of Mass-Spring-Dashpot Systems using Multiple-Model Adaptive Estimation (MMAE) Algorithms," *Proc. 11th Mediterranean Conference on Control and Automation - MED'2003*, Rhodes, Greece, June 2003.
- [49] **R. Cunha and C. Silvestre**, "SimModHeli: A dynamic simulator for model-scale helicopters", *Proc. 11th Mediterranean Control on Control and Automation - MED'2003*, Rhodes, Greece, June 2003.
- [50] **D. Soetanto, L. Lapierre, and A. Pascoal**, "Adaptive Nonsingular Path Following Control of Dynamic Wheeled Robots," *Proc. 11th International Conference on Advanced Robotics, ICAR 2003*, Coimbra, Portugal, June-July 2003.
- [51] **G. Libório, N. Paulino, R. Cunha, C. Silvestre, and M. I. Ribeiro**, "Terrain following preview controller for model-scale helicopters", *Proc. 11th International Conference on Advanced Robotics, ICAR 2003*, Coimbra, Portugal, June-July 2003.
- [52] **P. Weiss, J. Mascarell, M. Badica, D. Labbe, L. Brignone, L. Lapierre**, "FREESUB: Modular Control system for Intervention AUVs (IAUV)," *Proc. 13th International Symposium on Unmanned Untethered Submersible Technology (UUST03)*, Durham, New Hampshire, USA, August 24-27, 2003.
- [53] **R. Cunha and C. Silvestre**, "Dynamic Modeling and Stability Analysis of Model-Scale Helicopters with Bell-Hiller Stabilizing Bar", *Proc. AIAA Guidance Navigation and Control Conference*, Texas, USA, August 2003.
- [54] **R. Cunha, C. Silvestre, and A. Pascoal**, "A Path Following Controller for Model-Scale Helicopters," *Proc. European Control Conference ECC2003*, Cambridge, UK, September 2003.
- [55] **L. Lapierre, D. Soetanto, A. Pascoal**, "Adaptive Vision-Based Path Following Control of a Wheeled Robot," *Proc. European Control Conference ECC2003*, Cambridge, UK, September 2003.
- [56] **L. Lapierre, D. Soetanto, and A. Pascoal**, "Coordinated Motion Control of Marine Robots," *Proc. 6th IFAC Conference on Manoeuvring and Control of Marine Craft (MCMC2003)*, Girona, Spain, September 2003.
- [57] **L. Lapierre, D. Soetanto, and A. Pascoal**, "Nonlinear Path Following with Applications to the Control of Autonomous Underwater Vehicles," *Proc. IEEE CDC03*, Hawaii, December 2003.
- [58] **D. Soetanto, L. Lapierre, and A. Pascoal**, "Adaptive Nonsingular Path Following Control of Wheeled Robots," *Proc. IEEE CDC03*, Hawaii, December 2003.
- [59] **R. Quartau, F. Teixeira, S. Bouriak, J. Monteiro, and L. Pinheiro**, "Characterization of the continental shelf of Faial and Pico islands (Azores) using chirp echo character," *Proc. 4th Symposium on the Iberian Atlantic Margin*, Vigo, Spain.
- [60] **R. Quartau, F. Teixeira, J. Monteiro, T. Cunha, L. Pinheiro, and F. Cardigos**, "Sand resources on the continental shelf of Faial Island (Azores)" *Proc. 4th Symposium on the Iberian Atlantic Margin*, Vigo, Spain.
- [61] **Thomas Krause, Pedro Lima, Peter Protzel**, *Flugregler für ein autonomes Luftschiff* ("Flight control for an autonomous airship"), *German Conference on Autonomous Mobile Systems*, Karlsruhe, Germany, 2003.
- [62] **Gonçalo Neto, Hugo Costelha, Pedro Lima**, "Topological Navigation in Configuration Space Applied to Soccer Robots", *RoboCup 2003 International Symposium*, Padova, Italy, 2003.

- [63] **Carla Penedo, João Pavão, Pedro Nunes, Luis Custódio**, "RoboCup Advanced 3D Monitor", *RoboCup 2003 International Symposium*, Padova, Italy, 2003.
- [64] **Hans Lausen, Jakob Nielsen, Michael Nielsen, Pedro Lima**, "Model and Behavior-Based Robotic Goalkeeper", *RoboCup 2003 International Symposium*, Padova, Italy, 2003.
- [65] **Dejan Milutinovic, Jorge Carneiro, Michael Athans, Pedro Lima**, "A Hybrid Automata Modell of TCR Triggering Dynamics", *Proc. of IEEE Mediterranean Conference on Control and Automation, MED-2003*, 17-20 June, 2003, Rhodes, Greece, 2003.
- [66] **Dejan Milutinovic, Pedro Lima, Michael Athans**, "Biologically Inspired Stochastic Hybrid Control of Multi-Robot Systems", *ICAR 2003 - The 11th International Conference on Advanced Robotics*, June 30 - July 3, 2003, Coimbra, Portugal
- [67] **Andrés Garcia, Pedro Lima**, "Motion Formulation for Robot Formations Based on Scalar Fields", *ICAR 2003 - The 11th International Conference on Advanced Robotics*, June 30 - July 3, 2003, Coimbra, Portugal
- [68] **P. Lima, M. Isabel Ribeiro, Luis Custódio, José Santos-Victor**, "The RESCUE Project - Cooperative Navigation for Rescue Robots", *ASER'03 - 1st International Workshop on Advances in Service Robotics*, March 13-15, 2003 - Bardolino, Italy
- [69] **FELISBERTO P., JESUS S.M., STEPHAN Y. and DEMOULIN X.**, "Shallow water tomography with a sparse array during the INTIMATE'98 sea trial", *Proc. MTS/IEEE Oceans'2003*, San Diego (USA), September.
- [70] **JESUS S.M. and SOARES C.**, "Blind Ocean Acoustic Tomography with Source Spectrum Estimation", *Int. Conf. on Theoretical and Computational Acoustics*, Honolulu, Hawaii (USA), August.
- [71] **DE MARINIS E., CRISE A., GASPARINI O., JESUS S., PICCO P. and SALON S.**, "Passive Ocean Acoustic Tomography: results from the INTIMATE'00 and TOMPACO projects", *EGS-AGU-EUG Joint Assembly, Geophysical Research Abstracts*, vol. 5, 01211, European Geophysical Society, Nice, France, April.
- [72] **P. J. S. Gil, C. M. C. Antunes, H. T. C. Pedro**, "A Software Package for Studies on Spacecraft Entry in Planetary Atmospheres", *Proceedings of the 'International Workshop on Planetary Probe Atmospheric Entry and Descent Trajectory Analysis and Science'*, Lisbon, Portugal, 6-9 October 2003. To be published in ESA SP-544.
- [73] **João Sequeira, M. Isabel Ribeiro**, "A Geometric Approach to Single and Multiple Robot Control", *Proceedings do 7th IFAC Symposium on Robot Control, SYROCO 2003*, 1-3 de Setembro de 2003, Wroclaw, Polónia, pp. 137-142.
- [74] **João Sequeira, M. Isabel Ribeiro**, "A Layered Approach to Multiple Robot Control", *Proceedings da 9th IEEE International Conference on Methods and Models in Automation and Robotics, MMMAR2003*, 25 - 28 August 2003, Miedzzydroje, Poland, pp.745-750.
- [75] **Alberto Vale, M. Isabel Ribeiro**, "Environment Mapping as a Topological Representation", *Proceedings da 11th Int. Conf. on Advanced Robotics, ICAR03*, Coimbra, Portugal, 30.Junho 30 -3. Julho, 2003, pp.29-34
- [76] **João Sequeira, M. Isabel Ribeiro**, "Robot Team Control: a Geometric Approach", *Proceedings da 11th Int. Conf. on Advanced Robotics, ICAR03*, Coimbra, Portugal, 30.Junho 30 -3. Julho, 2003, pp. 1502-1507.
- [77] **Pedro Lima, Luis Custódio, M. Isabel Ribeiro, José Santos-Victor**, "The RESCUE Project: Cooperative Navigation for Rescue Robots" *Proceedings do 1st International Workshop on Advances in Service Robotics, ASER'03*, Bardolino, Itália, Março de 2003, pp. 94-101.
- [78] **Jacinto Nascimento, Jorge S. Marques, João M. Sanches**, "Estimation of Cardiac Phases in Echographic Images Using Multiple Models", *IEEE Int. Conf. Image Processing*, Barcelona, September 2003.
- [79] **João M. Sanches, Jorge S. Marques**, "A MAP estimation algorithm using IIR recursive filters", *Energy Minimization Methods in Computer Vision and Pattern Recognition, IAPR, Lecture Notes in Computer Science*, 2683, Springer, 436-449, July 2003.

- [80] **Jorge S. Marques, Pedro M. Jorge, Arnaldo J. Abrantes, J. M. Lemos**, Tracking Groups of Pedestrians in Video Sequences, IEEE Workshop on Multi-Object Tracking, Madison, June, 2003.
- [81] **João M. Sanches, Jorge S. Marques**, A 3D Ultrasound System for Medical Diagnosis, Pattern Recognition and Image Analysis, First Iberian Conference IbPRIA 2003, 893-901, Springer Verlag LNCS 2652, June 2003.
- [82] **Jorge G. Silva, Jorge S. Marques, João M. Lemos**, A geometric approach to motion tracking in manifolds, 13th IFAC Symposium on System Identification, Rotterdam, June 2003.
- [83] **André T. Martins, Pedro M. Q. Aguiar, and Mário A. T. Figueiredo**, Navigating in Manhattan: 3D orientation from video without correspondences, IEEE International Conference on Image Processing ICIP'03, Barcelona, Spain, September 2003
- [84] **Rui F. C. Guerreiro and Pedro M. Q. Aguiar**, Estimation of Rank Deficient Matrices from Partial Observations: Two-Step Iterative Algorithms, Energy Minimization Methods in Computer Vision and Pattern Recognition, Lisboa, Portugal, July 2003, Lectures Notes in Computer Science, Springer-Verlag.
- [85] **Francisco M. Garcia, Isabel M. G. Lourtie**, Estimation of Locally Covariance Matrices from Data, IEEE International Conference on Acoustics, Speech and Signal Processing, Hong Kong, April 2003.
- [86] **Maria João Rendas, Isabel M. G. Lourtie, Georges Pichot**, Adaptive Sampling for Sand Bank Mapping using an Autonomous Underwater Vehicle Equipped of na Altimeter, International Symposium on Environmental Software Systems, Viena, Austria, Maio 2003.
- [87] **P. Lopes, J. Xavier, V. Barroso**, Exploiting 2nd Order Statistics in Bayesian Signal Reconstruction Problems, IEEE International Conference on Acoustics, Speech and Signal Processing (ICASSP'03), Hong-Kong, April 2003.
- [88] **T. Patrão, J. Xavier, V. Barroso**, An Interior Point Algorithm for Joint Symbol Detection and Multichannel Acquisition in Fast-Fading Narrowband Channels, Proceedings of the IEEE Signal Processing Workshop on Signal Processing Advances in Wireless Communications (SPAWC'03), Rome, Italy, June 2003.
- [89] **P. Flandrin and P. Gonçalvès**, Sur la décomposition modale empirique, GRETSI, Paris (FR), 2003.
- [90] **G. Rilling, P. Flandrin and P. Gonçalvès**, On empirical mode decomposition and its algorithms, IEEE-EURASIP Workshop on Nonlinear Signal and Image Processing NSIP-03, Grado (I), 2003.
- [91] **João Gomes, Victor Barroso**, Doppler Compensation in Underwater Channels Using Time-Reversal Arrays, IEEE International Conference on Acoustics, Speech and Signal Processing (ICASSP'03), Hong-Kong, China, April 2003.
- [92] **José A.A. Moreira, Carlos F. Bispo**, Performance Improvement through Active Idleness, 11th Mediterranean Conference on Control and Automation, Greece, June 2003.
- [93] **E. B. Bacca Cortes, E. Caicedo Bravo, J. Santos-Victor** - A Behaviour-Based Homing Strategy Implemented On A Layered Control Architecture, 13th International Symposium on Measurement and Control in Robotics- Toward Advanced Robots: Design, Sensors, Control and Applications - ISMCR'03, Madrid (Spain) December 2003.
- [94] **Manuel Cabido Lopes, José Santos-Victor** - Motor Representations for Hand Gesture Recognition and Imitation, IROS Workshop on Robot Programming by Demonstration, Las Vegas, SA, Oct. 31st, 2003.
- [95] **Roger Freitas, José Santos-Victor, Mário Sarcinelli-Filho, Teodiano Bastos-Filho** - Performance Evaluation of Incremental Eigenspace Models for Mobile Robot Localization, ICAR 11th International Conference on Advanced Robotics, Coimbra, Portugal, June 30 - July 3 2003.
- [96] **Manuel Cabido Lopes, José Santos-Victor**, Visual Transformations in Gesture Imitation: what you see is what you do, ICRA - IEEE International Conference on Robotics and Automation, Taiwan, September 2003.

- [97] **José Santos-Victor, Alexandre Bernardino**, Vision-based navigation, environmental representations and imaging geometries, Robotics Research, 10th International Symposium, R. Jarvis and A. Zelinsky (Eds), Springer, 2003.
- [98] **HongFei G, Fernando Contreiras, Nuno Costa, Agostinho Rosa**. Simulation model of olive fly population dynamics and Adaptation by Genetic Algorithms. Proc IASTED IC on ASM, pp 169-174, 2003.
- [99] **AV Cruz, AC Pimentel, CC Rosa, AC Rosa**. Characterization of Yogi Meditation Stages by EEG. Proc IASTED IC Biomedical Engineering, BIOMEd'03, pp 27-32, 2003.
- [100] **Agostinho Rosa** Application of Evolutionary Computing to Games and Scheduling. Proc Mathematical Techniques and Problems in Telecommunications- 2003, September, Tomar, pp 281-312, CIM 24

G) IN NATIONAL CONFERENCES (14) :

- [101] **L. Silva, J. Santos, M. Neves, C. Silvestre, P. Oliveira, and A. Pascoal**, "Ferramentas de Inspeção e Diagnóstico de Obras de Protecção Portuária, " 2ª Jornadas Portuguesas de Engenharia Costeira e Portuária, Sines, Outubro 2003.
- [102] **Miguel Arroz, Vasco Pires, Luis Custódio**, "Logic based Distribution Decision System for a Multi-Robot Team", *Actas do Encontro Científico do Robotica 2003 - Festival Nacional de Robotica*, 2003.
- [103] **Carla Penedo, João Pavão, Pedro Lima, M. Isabel Ribeiro**, "Markov Localization in the Robocup Simulation League", *Actas do Encontro Científico do Robotica 2003 - Festival Nacional de Robotica*, 2003.
- [104] **Pedro Marcelino, Pedro Nunes, Pedro Lima, M. Isabel Ribeiro**, "Improving Object Localization Through Sensor Fusion Applied to Soccer Robots", *Actas do Encontro Científico do Robotica 2003 - Festival Nacional de Robotica*, 2003.
- [105] **Carla Penedo, João Pavão, Pedro Lima, M. Isabel Ribeiro**, "Markov Localization in the RoboCup Simulation League", *Proceedings do Encontro Científico do 3º Festival Nacional de Robótica, ROBOTICA 2003, Lisboa, Maio de 2003*. Por ter sido considerado pelos *chairs* como um dos três melhores artigos apresentados neste encontro, este trabalho foi publicado na revista *Robótica*, 4º trimestre-2003, pp.16-21.
- [106] **Pedro Marcelino, Pedro Nunes, Pedro Lima, M. Isabel Ribeiro**, "Improving object localization through sensor fusion applied to soccer robots" *Proceedings do Encontro Científico do 3º Festival Nacional de Robótica, ROBOTICA 2003, Lisboa, Maio de 2003*.
- [107] **Nuno de Castro, Rodrigo Matias, M. Isabel Ribeiro**, "Target tracking using fuzzy control", *Proceedings do Encontro Científico do 3º Festival Nacional de Robótica, ROBOTICA 2003, Lisboa, Maio de 2003*.
- [108] **Paulo M. Oliveira, Victor A. N. Barroso**, "Numerical Differentiation of Discrete-Time Sequences," IV Conferência em Telecomunicações, CONFTELE 2003, Aveiro, Portugal, 2003.
- [109] **Miloud Frikel, Victor A. N. Barroso**, "Mobile Positioning: Angle of Arrival Estimation, IV Conferência em Telecomunicações, CONFTELE 2003, Aveiro, Portugal, 2003.
- [110] **Sebastien Bausson, Victor A. N. Barroso**, "Estimation of a Rank-One Signal Subspace in Small Sample Regime," IV Conferência em Telecomunicações, CONFTELE 2003, Aveiro, Portugal, 2003.
- [111] **João Gomes, Victor Barroso**, *QR-RLS Adaptation of Modular Multichannel Lattice Filters*, 4th Conference on Telecommunications (ConfTele'2003), Aveiro, Portugal, June 2003.
- [112] **Carlos F. Bispo**, *Renovação Tecnológica ou Renovação na Gestão de Operações?* 1º Congresso Nacional da Administração Pública, Lisbon, November 2003.
- [113] **Rogério Largo, Agostinho Rosa**. "Sleep EEG Processing with Wavelets", Proc 7th Portuguese Conference on BioEng 2003.

[114] **Pedro Gouveia, Ricardo Oliveira, Agostinho Rosa.** "Sleep Apnea related micro arousal detection with EEG Analysis", Proc 7th Portuguese Conference on BioEng 2003,

H) TECHNICAL REPORTS (28) :

[115] **A. Alcocer, P. Oliveira, A. Pascoal,** "Study and Implementation of an Acoustic-Based Positioning System for Autonomous Underwater Vehicles," DSORL-ISR Technical Report, October 2003.

[116] **J. Alves, C. Silvestre,** "A Reliable Datagram Protocol for Distributed Vehicular Applications," DSORL-ISR Technical Report, September 2003.

[117] **P. Alves, C. Silvestre,** "Nonlinear Optimal 2D Radar Target Tracking Techniques," DSORL-ISR Technical Report, November 2003.

[118] **E. Barros and A. Pascoal,** "AUV Dynamics: Modeling and Parameter Estimation using Analytical and Semi-Empirical Methods," DSORL-ISR Technical Report, October 2003.

[119] **D. Carvalho, T. Filho, and A. Pascoal,** "Development of a Simulator for a Remotely Operated Vehicle (ROV)," joint DSORL-ISR/UFES Technical Report, September 2003.

[120] **R. Cunha, C. Silvestre.** "Dynamic Modeling and Stability Analysis of Model-Scale Helicopters with Bell-Hiller Stabilizing Bar," DSORL-ISR Technical Report, March 2003.

[121] **R. Cunha, C. Silvestre,** "A Dynamic Simulator for Model-Scale Helicopters," DSORL-ISR Technical Report, May 2003.

[122] **S. Fekri, M. Athans, and A. Pascoal,** "RMMAC: A new Robust Adaptive Control Strategy " DSORL-ISR Technical Report, November 2003.

[123] **R. Ghabcheloo, A. Pascoal, C. Silvestre, and I. Kaminer,** "Coordinated Path Following Control of Multiple Wheeled Robots using Linearization Techniques," DSORL-ISR Technical Report, November 2003.

[124] **L. Lapierre, D. Soetanto, and A. Pascoal,** "Nonlinear Coordinated Path Following Control of Multiple Marine Vehicles," DSORL-ISR Technical Report, July 2003.

[125] **L. Lapierre and A. Alcocer,** "Contributions to the Development of a Simulator for Intervention AUVs," joint DSORL-ISR/FREESUB Team Technical Report, October 2003.

[126] **G. Libório, N. Paulino, C. Silvestre, R. Cunha,** "Hardware in the Loop Simulation Techniques for Autonomous Helicopters," DSORL-ISR Technical Report, November 2003.

[127] **R. Oliveira, C. Silvestre,** "Petri Net based Supervision Techniques for the Design of Mission Control Systems for Autonomous Vehicles," DSORL-ISR Technical Report, November 2003.

[128] **R. Oliveira, C. Silvestre,** "A Mission Programming Environment for Multiple Autonomous Vehicles," DSORL-ISR Technical Report, October 2003.

[129] **N. Paulino, C. Silvestre, R. Cunha,** "LMI Based H₂ Terrain Tracking Preview Controller for Unmanned Helicopters ," DSORL-ISR Technical Report, November 2003.

[130] **F. Teixeira,** "Concurrent Mapping and Localization using Geophysical Navigation with application to the navigation of an Autonomous Underwater Vehicle - Part 1 : Geophysical Navigation," Report INGMARDEP 07/FCT/2003 - 10/03/2003.

[131] **F. Teixeira,** "Concurrent Mapping and Localization using Geophysical Navigation with application to the navigation of an Autonomous Underwater Vehicle - Part 2 : Concurrent Mapping and Localization," Report INGMARDEP 08/FCT/2003 - 10/03/2003.

- [132] **J.F. Vasconcelos, J. Calvário, P. Oliveira, C. Silvestre**, "GPS Aided IMU for Unmanned Air Vehicles," DSORL-ISR Technical Report, December 2003.
- [133] **Pedro Lima, Sónia Marques, Andrés García**, "Survey on Cooperative Formation Flying Spacecraft Navigation, Guidance and Control Strategies Selection and Algorithms Identification - Conceptual Framework Definition", TN1-FEMDS-18Sep2003
- [134] **Pedro Lima, Sónia Marques**, "Survey on Multi-Agent Systems: Feasibility, Techniques, Methodologies and Design Tool(s)", TN2-FEMDS-20Oct2003
- [135] **Pedro Lima, Andrés García, Sónia Marques**, "Phase I Report of Formation Estimation Methodologies for Distributed Spacecraft", P1R-FEMDS-22Dec2003
- [136] **João Cristóvão, Carlos Marques, Pedro Lima, Maria Isabel Ribeiro**, "RAPOSA First Milestone Report (01 / 03 / 2003 - 30 / 09 / 2003)"
- [137] **Soares C. and Jesus S.M.**, "Range-dependent acoustic tomography: modeling an upwelling filament using an asymmetric Gaussian function", 05/03-SiPLAB Report, University of Algarve, November.
- [138] **Felisberto P., LOPES C. and CARMO A.**, "Ultra Light Vertical Array / Remote Data Acquisition System", Rep. 03/03, SiPLAB Report, University of Algarve, April.
- [139] **JESUS S.M., SOARES C. and SILVA A.J.**, "Acoustic Oceanographic Buoy testing during the Maritime Rapid Environmental Assessment 2003 sea trial", Rep. 04/03, SiPLAB Report, University of Algarve, October.
- [140] **JESUS S.M. and SOARES C.**, "Tomografia Passiva Costeira (TOMPACO) - Inversion results with passive data - Phase 3", Rep. 02/03, SiPLAB Report, University of Algarve, March.
- [141] **S. Guerreiro, J. Tribolet, J. Sequeira**, "Business modelling for robot mission control", Instituto de Sistemas e Robótica, Technical Report RT-603-03, December 2003.
- [142] **João Silva Sequeira, Maria Isabel Ribeiro**, Single And Multiple Robot Control: A Geometric Approach, Technical Report RT-602-03, Institute for Systems and Robotics (ISR/IST), 2003.

4.0 LABORATORY FACILITIES AND SERVICES

4.1 COMMON FACILITIES

ISR/IST has a computer network infra-structure based on 2 DEC Alpha servers and 7 DEC Alpha workstations. The Computing Center group runs also three Macintosh computers and 4 laser printers. More than 200 users have accounts on the isr.ist.utl.pt domain, and more than 100 machines, including PCs, SUN workstations, Macintoshes and others, are currently linked to the network.

4.2 LABORATORY FACILITIES

INTELLIGENT SYSTEMS Lab (IS)

The ISLab offers the main following facilities:

1 RWI ATRV-Jr mobile robot, 4-wheel drive, equipped with 16 sonars, GPS, inertial navigation module and a compass, pan and tilt vision system and one SICK Laser scanner (shared with the Mobile Robotics and Computer and Robot Vision Labs).

1 Blimp aerial robot, with pan and tilt vision system, 3 servomotors, RF link for remote control and remote video-link for video transmission

4 Nomadic Super-Scout II mobile robots, equipped with 16 sonars and 2 cameras each, one of them part of an omnidirectional catadioptric system.

14 Philips 740K USB Web Cams, used in the soccer robots

9 WaveLan Wireless Ethernet PCMCIA boards.

1 Mobile Platform, built at ISR, with tricycle-like kinematics, 60W and 90W motors, open control and guidance architecture based on 2 Pentium motherboards, and 2 on-board cameras.

1 Mobile Platform, built at ISR, with differential drive kinematics, 2*360W motors, open control and guidance architecture based on ai80486 motherboard.

1 Real-Time RF video link.

Matlab and Simulink software for different simulation projects.

Several cameras, used for visual servoing and vision-based navigation applied to manipulators and mobile robots.

1 Space Mouse device, for teleoperation of mobile robots and manipulators.

1 PUMA 560 manipulator, whose Mark III controller was partially replaced by Trident Robotics TRC 004/6 boards, which allow manipulator control by an external PC.

25 Pentium Personal Computers (including 5 laptops) - under Linux and Windows 98/2000/XP OS.

MOBILE ROBOTICS Lab (LRM)

The LRM offers the main following facilities:

- Robuter mobile platform, with a ring of 24 ultrasound sensors, and two on-boards processors: Motorola 68020@16MHz running the real-time operating system Albatros, and a Pentium@200Mhz running Windows NT. A laser scanner (Lasernet system) for localisation purposes with artificial landmarks is installed on the platform.
- 2 Scout mobile platforms with on-board computer, vision camera and wireless Ethernet
- 1 ATRV Jr Rover with ultrasound sensors, GPS and Inertial Measurement Unit. This mobile platform is shared with the Intelligent Control and Computer Vision Laboratories.
- A 6 dof robot arm (GT 6A Robotique) installed on top the Robuter mobile platform.
- 3 Mb/s wireless ethernet systems with two Access Points supporting roaming operation.
- 6 complete sets of the LEGO system for Mobile Robotics
- A Laser Range Finder from the Riegl supplier with range and luminance measurement.
- 2 Sick Laser Scanner.
- Three computer controlled Pan & Tilt Units from Direct Perception.
- Video cameras, including two Quick Cams and a Network Eye supporting direct display of real scenes on the Internet.
- 10 Pentium PCs + 5 portable Pentiums. Four more PCs are available from external partners.
- Two laser printers, and one DeskJet colour printer.
- A large open space appropriate for mobile robotics navigation experiments.

COMPUTER VISION Lab (VISLAB)

The VisLab is equipped with various PCs , a DEC-Alpha Workstation, various cameras (CCD, CMOS, Colour, Black & White, Digital or Analogue) and image frame grabbers, a pan-tilt unit and several pan-tilt cameras.

Special equipment consists of a high-speed 4 degrees of freedom binocular head – Medusa - developed for research in active vision, a TRC LabMate mobile platform, two Nomad Superscout mobile platforms, equipped with vision and an on-board computer. Additionally various home-made small robots have been developed and are used for experiments in the areas of vision based control.

More recently a smaller active vision head was built and installed on a mobile vehicle for experiments in vision based navigation with extra degrees of freedom.

SIGNAL PROCESSING Lab (SP) - LISBON

The SP Lab offers capabilities to develop and test both software and hardware products for digital signal processing. Presently, the activities in course include the design and implementation of modems for underwater acoustic data communications, the development of very low bit rate video compression algorithms for underwater acoustic transmission, and testing of navigation and guidance techniques for autonomous robotics.

- 3 Intel 486 personal computers
- 3 Intel Pentium personal computers
- 1 NeXT workstation
- 1 Hewlett-Packard LaserJet 4M printer
- 1 Hewlett-Packard OfficeJet Pro 1150C color inkjet printer/scanner
- 10 Mbit/s thin Ethernet LAN interfacing the Signal Processing Laboratory to the ISR Network
- 4 processor DEC2100 Alpha server and 10 workstations of various types including DEC Alphas, HP's and SGI's. It also has several PC's, b/w laser and wax colour printers.
- 1 Mini robot platform KHEPERA
- 1 ORCA underwater acoustic communication system
 - 1 surface modem
 - 1 programmable acoustic receiver
 - 1 underwater modem
- 1 Motorola software development system for the DSP56000 digital signal processor (DSP)
- 1 Motorola DSP96002 hardware/software DSP development system
- 2 Analog Devices SHARC ADSP21061 hardware/software DSP development systems
- 1 Xilinx field programmable gate array (FPGA) hardware/software development system
- 1 National Instruments PCI-MIO-16E-4 multifunction data acquisition board and LabView virtual instrumentation software
- 1 Matrox Rainbow Runner video capture board
- 1 TEAC CS-391 multichannel data recorder
- 1 Sony TCD-D3 portable digital audio tape (DAT) stereo recorder
- 1 Goldstar OS-9040D 40 MHz analog oscilloscope
- 1 Hewlett-Packard HP8116A 50 Mhz function generator
- 1 Escort EGC 3230 2 Mhz function generator with 100 Mhz frequency meter
- 1 Sony F670ES power amplifier
- 1 Kiotto KT-1990EX digital multimeter

- 1 GW ST3030TD triple power supply
- 1 Weller WTCP-S soldering station

SIGNAL PROCESSING Lab (SP) - ALGARVE

- 1 room with 7 research desks + electronics testing bench internal 100/1000 Mb computer network w/router, NFS, printers, automatic backups, RAID5, etc...
- 1 vertical line array (16 hyd) + radio buoy + acquisition system
- 1 remote buoy w/ wireless lan
- 1 260-900 Hz high power acoustic sound source (tomography)

DYNAMICAL SYSTEMS AND OCEAN ROBOTICS LAB (DSOR)

Vehicles

- **DELFIN Autonomous Surface Vehicle (ASC)** - an autonomous surface craft (Catamaran-type) to carry out experimental research in the area of ocean robotics and to perform scientific missions at sea.
- **INFANTE Autonomous Underwater Vehicle (AUV)** - an autonomous underwater vehicle to carry out experimental research in the area of ocean robotics and to perform scientific missions at sea.
- **R/C Helicopter VARIO XTREM** - a small helicopter (payload of 4 Kg) to carry out experimental research in the area of autonomous aerial robotics.
- Small **Zodiac** to support operations at sea.

Mechanical/ Electrical Equipment

- **Pressure Chamber** - to test the marinization of equipment down to depths of 600 meters.
- **Mechanical / Electric shop** (8th Floor of ISR) - basic equipment and tools to machine pieces and to assemble circuit boards.
- **Crane** with the capacity of 2500 Kg.
- **Industrial air compressor.**

Actuators and Sensors for Robotic Ocean Vehicle Development and Operation (part of the equipment is dedicated to the operation of the INFANTE AUV)

- *Actuators* - 5 electrical thrusters.
- 3 rate gyros, 2 pendulums and 1 fluxgate (Watson's Attitude & Heading Reference Unit AHRS-C303);
- 3 rate gyros, 3 accelerometers and 1 magnetometer (SEATEX MRU-6)
- 3 rate gyros, 2 pendulums and 1 magnetometer (KVH attitude reference unit).
- 1 flowmeter TSA-06-C-A (EG & G Flow Technology);
- 2 depth cells DC 10R-C (Transinstruments);
- 2 echosounders ST200 (Tritech);
- 2 echosounders ST500 (Tritech);
- GIB (GPS Intelligent Buoys) - GPS based underwater positioning system, with target tracking capabilities.
- 1 Doppler Log TSM 5740 with 4 beams in a Janus configuration, operating at 300 KHz (Thomson-ASM);
- one set of 3 rate gyros, 2 pendulums and 1 directional gyro from Humphreys.
- 1 *Long Baseline Positioning System* for underwater vehicle positioning - 1 transducer and 4 transponders.

- 1 DGPS (*Differential Global Positioning System*) for accurate surface vehicle navigation - 4 Motorola Encore unit and 3 FREEWAVE radios.

Hardware and Software Development Systems for Vehicle Simulation and Real-Time Vehicle Control.

- *Hardware for real-time applications* - 3 Gespac 68030/68882 computers; a T805 transputer array; 4 MPL stand-alone 68020/60881 computers.
- *3 Single Board Computers RTD/USA*
- *Development System* - Microware FASTRAK development software running on a SUN-Workstation; professional OS9 for Gespac development systems.

Software Tools for Navigation, Guidance, and Control System Design.

INTEGRA - Modeling and simulation tool for *the integrated analysis and design of navigation, guidance and control systems for autonomous vehicles*. The software was developed at IST/ISR and is built around the commercially available package MATLAB. The package is specially geared towards the development of dynamic models of robotic ocean vehicles. Furthermore, it provides the means to assess the combined performance of navigation, guidance and control systems prior to their implementation.

General Computer Facilities.

- 8 Desktop PCs
- 6 Laptop PCs
- 1 Macintosh
- 2 Laser printers

EVOLUTIONARY SYSTEMS AND BIOMEDICAL ENGINEERING Lab (LASEEB)

The Laseeb offers the main following facilities on digital signal processing for biomedical engineering, digitalization and development for multimedia Applications.

20 Personal Computers running Windows 98/NT4/2000 and Linux.

2 Laser printer,

2 color inkjet printers

1 Video Capture Board MIRO VIDEO DC30

3 Cd-RW Recorders

1 Tape Backup 12 Gb

1 Scanner

1 Biological amplifier Medelec

1 Biological amplifier Braintronics

1 Biological amplifier CAPS

2x30 ch. A/D Acquisition DT 2834 16 Hz

2x16 ch. A/D Acquisition DT 2821 150 Hz

1x16 ch. A/D Acquisition DT 2811 30 Khz

1x8 ch A/D Acquisition PCMCIA 50Khz

AERONAUTICS GROUP

- Flight test laboratory - Instrumentation packages for Alpha Jet, A-7 and Aviocar, and calibration, and data processing equipment.
- Transfer of Flight Simulator from Delft University of Technology to IST.