



INSTITUTE FOR SYSTEMS AND ROBOTICS

Annual Report - 2002



Lisbon Pole



*Torre Norte, Piso 7
IST, Av. Rovisco Pais
1049 - 001 Lisboa
Portugal*

Director

Prof. João José dos Santos Sentieiro

Vice - Director

Prof. Maria Isabel Lobato de Faria Ribeiro

Torre Norte, 7º Piso

IST, Av. Rovisco Pais

1049 - 001 Lisboa

Portugal

Tel.: + 351 21 841 82 89

Fax.: + 351 21 841 82 91

e-mail: jjss@isr.ist.utl.pt

Table of Contents

OVERVIEW	1
1. ISR IN NUMBERS	3
2. RESEARCH TEAM AND INTERESTS	5
2.1 Members and Collaborators	5
2.2 Current Research Interests	7
2.2.1 <i>Intelligent Systems</i>	7
2.2.2 <i>Computer and Robot Vision</i>	9
2.2.3 <i>Mobile Robotics</i>	11
2.2.4 <i>Signal Processing</i>	12
2.2.5 <i>Evolutionary Systems and Biomedical Engineering</i>	12
2.2.6 <i>Dynamical Systems and Ocean Robotics</i>	15
2.2.7 <i>Aeronautics</i>	21
3. RESEARCH ACTIVITIES	23
3.1 Research Projects	23
3.1.1 <i>Underwater and Ocean Robotics</i>	23
3.1.2 <i>Cooperative Robotics</i>	27
3.1.3 <i>Educational Robotics</i>	29
3.1.4 <i>Image Processing</i>	30
3.1.5 <i>Underwater Acoustics</i>	32
3.1.6 <i>Computer Vision</i>	35
3.1.7 <i>Artificial Intelligence</i>	37
3.1.8 <i>Biomedical Engineering</i>	38
3.1.9 <i>Communications</i>	38
3.1.10 <i>Aeronautics</i>	41
3.1.11 <i>Unmanned Air Vehicles</i>	44
3.1.12 <i>Non-Linear Control</i>	45

3.2	Post-Docs Activities Report	47
3.2.1	<i>Activity Report of Didik Soetanto</i>	47
3.2.2	<i>Activity Report of Lionel Lapierre</i>	50
3.2.3	<i>Activity Report of Sergey Romyantzev</i>	53
3.2.4	<i>Activity Report of Ognyan Manolov</i>	55
3.2.5	<i>Activity Report of Vanessa Corre</i>	57
3.2.4	<i>Activity Report of Sandra Clara Gadanho</i>	58
3.3	Theses	61
3.3.1	<i>Theses Concluded During 2002</i>	62
3.3.2	<i>Theses in Progress During 2002</i>	73
3.4	Advanced Training	89
3.4.1	<i>Courses</i>	89
3.4.2	<i>Seminars</i>	89
3.4.3	<i>Reading Groups</i>	91
3.4.4	<i>Visits Abroad</i>	91
3.4.5	<i>Supervision of Students Enrolled in Foreign Universities</i>	91
3.5	Congress, Meetings and Presentations	93
3.5.1	<i>Invited Talks</i>	93
3.5.2	<i>Participations</i>	94
3.6	Service Activities	97
3.6.1	<i>Editorial Boards</i>	97
3.6.2	<i>Advisory Boards</i>	97
3.6.3	<i>Programme and Technical Committees</i>	98
3.6.4	<i>Chairperson</i>	100
3.6.5	<i>Reviewers</i>	101
3.6.6	<i>Other Activities</i>	103
3.7	Academic Activities	105
3.8	Distinguished Visitors	109
3.9	Special Events	111
3.9.1	<i>Infante and Delfim Sea Trials</i>	111
3.9.2	<i>Summer School on Cooperative Robotics</i>	111

3.9.3	<i>Building a Junior Football Player for Robótica 2003</i>	112
3.9.4	<i>Robotics and Artificial Intelligence for high School Students</i>	112
3.9.5	<i>The 10th Mediterranean Conference on Control and Automation (MED 2002)</i>	113
3.10	Awards	117
3.11	Publications	119
3.12	Submitted Pappers	129
4.	LABORATORY FACILITIES AND SERVICES	133
4.1	Common Facilities	133
4.1	Laboratory Facilities	133

OVERVIEW

Since its foundation, ISR (Lisbon) has given special attention to international cooperation in order to strengthen and broaden its scientific competence. Two types of cooperation are especially noteworthy: firstly, participation in R&D projects in conjunction with universities, research centers, and European businesses of note under the auspices of programs funded by the Portuguese Science and Technology Foundation, European Community and other agencies; and, secondly, training initiatives, primarily through master and doctoral programs. These initiatives have involved not only the Instituto Superior Técnico (IST) and the University of Algarve (UA) but also universities and research centers in Europe and the United States.

In 2002¹ we have continued our efforts in order to push theoretical developments in the fields of Marine Robotics, Underwater Acoustics, Mobile Communications, Computer Vision and Cooperative Robotics promoting international cooperation through joint projects; trying to reinforce the teams with full time and post-doc researchers; bridging the gap between theory and practice by pushing the collaboration with marine scientists, environmental experts and government agencies interested in the management of ocean resources and civil protection; trying to endow researchers with the infra-structures and technical personnel required for the development and testing of ocean equipment and vehicles.

Additionally, a substantial effort was made to prepare two proposals to the “Programa Nacional de Re-equipamento Científico”, of the “Fundação para a Ciência e Tecnologia” that further establishes strategic research directions and includes several pieces of equipment that are of utmost importance for the full development of the R&D goals.

Also special attention was given by ISR (Lisbon) to the active promotion of scientific culture and public understanding of science, both within Portugal and Worldwide. Within this context ISR-Lisbon has, with the support of FCT and “Ciência Viva”, participated in a number of initiatives aiming to increase the levels of public understanding, awareness of, and involvement in, issues concerning science and technology. In particular, in 2002 ISR-Lisbon has seen its proposal to organize the RoboCup2004 in Portugal not only supported by the Portuguese Ministries of Science and Technology and Science and Higher Education but approved by the Robocup Federation. Other initiatives involving ISR researchers and high school students have been organized as well.

In 2002 ISR has offered several courses in the Doctoral and Master Programs in Electrical and Computer Engineering of IST, as well as other post-graduate level courses. Also seminars were organized even though not with the desired weekly periodicity. The courses and seminars were attended by a large number of Ph.D. students and faculty.

In 2002, 144 senior and junior researchers have developed their research activities within ISR (Lisbon Pole). These included 27 professors, 1 Principal Researcher, 7 post-docs, 44 Ph. D. Students, 26 M.Sc. Students and 39 undergraduate research trainees.

During 2002, the institute researchers have been involved in a large number of national and international R&D projects, financial resources being provided at a national (FCT, ICCTI, Ciência Viva, private companies) and international level (EU, and others), contributing to increase the international visibility of the institution. As a result of these activities 5 M.Sc. and 10 Ph.D. theses were concluded, 2 Books were published and 12 papers were published in books, 29 papers were published in well known international journals, and 74 papers presented at prestigious international conferences. Steps keep being taken to encourage researchers to increase the publication of their research results in archive journals. Also the number of publications by Post-Docs is, in general, beyond expected and hence efforts should be made by their supervisors in order to change the situation.

¹ In 2002, the Associate Laboratory ISR-Lisbon in partnership with the other 3 founding units (o Centro de Estudos em Inovação, Tecnologia e Políticas de Desenvolvimento do Instituto Superior Técnico - IN+, o Centro de Recursos Minerais, Mineralogia e Cristalografia - CREMINER, da Universidade de Lisboa e o Centro do IMAR da Universidade dos Açores) has been involved in a large number of activities that will be described in a different report.

The training of young researchers has pursued, involving 44 Ph.D. Students (Portuguese and foreigners) and 26 M. Sc. Students (Portuguese). Ten researchers have concluded their doctoral theses, and 5 researchers have concluded their M. Sc. theses. Also, young licenciates from several European countries have come to participate in short and medium term research initiatives.

Several ISR researchers have stayed short or long periods abroad, as visiting or invited professors, researchers or students. Several foreign senior and junior researchers have visited and stayed with ISR.

The participation in editorial boards of international journals, and in the program committees of international conferences of high reputation was also very active.

ISR has organized the 10th Mediterranean Conference on Control and Automation (MED2002) and a Summer School on Cooperative Robotics. The Workshops “Building a Junior Football Player for Robótica 2003” and “Robotics and Artificial Intelligence for High School Students” were also organized aiming at motivating high school students for Science and Technology.

Following comments made by the international evaluation panel and internal discussions the AIMS Lab and the IC Lab have merged and given rise to the Intelligent Systems Lab.

As closing remarks I would like to stress the fact that despite the financial difficulties, due to changes in Government and in the Science and Technology Public Policies (the usual FCT “plurianual” financing is now delayed for more than one year, the same happening with the financing of a large number of projects), the international visibility of ISR and in particular of some of his groups has increased significantly. This fact translates not only on the increasing number of foreign graduate students and post-docs wishing to pursue their research carriers at ISR, but also on the international contacts leading to collaboration projects and in the interest that Workshops and Conferences organized by ISR are raising in the scientific community.

However, it is my belief that if FCT does not urgently fulfill the agreement signed with ISR in 2001, concerning the plurianual financing and the hiring of 14 new post-doc researchers and 4 technical staff, it will be no longer possible to maintain the degree of excellency that has been recognized to our institution by the independent international evaluation panels. Also, if the “re-equipment program” launched by the FCT in 2001 and presently frozen is not resumed, top institutions like ours will have to review their strategic objectives, with natural negative consequences for the progress of science and technology in Portugal.

As in previous years, we urge again the host institution, IST, to recognize the research and graduate advising contributions of the faculty through the assignment of different classroom teaching loads and through the increase of administrative and technical support for all our laboratories.

João Sentieiro
ISR, April 17, 2003

1. ISR IN NUMBERS

(2002)

Research Team:

University Professors:	27
Principal Researchers:	01
Post-Docs:	07
Ph.D. Students:	44
M.Sc. Students:	26
Undergraduate Students:	39

Total: 144

***Research Projects:* 39**

***Doctoral theses concluded:* 10**

***Master theses concluded:* 05**

Publications:

Books:	02
In Books:	12
In International Journals:	29
In National Journals:	01
In International Conferences:	74
In National Conferences:	09
Technical Reports:	21

(2001)

Research Team:

University Professors:	20
Principal Researchers:	01
Post-Docs:	04
Ph.D. Students:	51
M.Sc. Students:	26
Undergraduate Students:	35

Total: 137

***Research Projects:* 41**

***Doctoral theses concluded:* 03**

***Master theses concluded:* 11**

Publications:

Books:	00
In Books:	05
In International Journals:	22
In National Journals:	02
In International Conferences:	78
In National Conferences:	01
Technical Reports:	12

2. RESEARCH TEAM AND INTERESTS

2.1 MEMBERS AND COLLABORATOR

THEORY GROUP:

Michael ATHANS, *Principal Researcher*
Luis Torres MAGALHÃES, *Full Professor IST*

INTELLIGENT SYSTEMS:

Carlos PINTO-FERREIRA, *Associate Professor (IST)*
Pedro LIMA, *Assistant Professor (IST)*
Luis M. CUSTÓDIO, *Assistant Professor (IST)*
Sandra GADANHO, *Post -Doc, FCT grantee*
Sónia MARQUES, *Adj. Professor (IPS), Ph.D. St.*
Rodrigo VENTURA, *Teaching Assistant (IST), Ph.D. St.*
Dejan MILUTINOVIC, *Ph.D. St., FCT grantee*
Vijay SARGUNAR, *Ph.D. St., ISR grantee*
Andrés GARCÍA, *Ph.D. St., ISR grantee*
Miguel GARÇÃO, *Ph.D. St.*
Márcia MAÇÃS, *M.Sc. St.*
Bruno DAMAS, *M.Sc. St.*
Pedro VALE, *M.Sc. St.*
Carla PENEDO, *M.Sc. St.*
João PAVÃO, *M.Sc. St.*
Pedro NUNES, *M.Sc. St.*
Maria Ivone FERNANDES, *M.Sc. St.*
João FRAZÃO, *Research Assistant, FCT grantee*

Hans LAUSEN, *Undergrad St. (Aalborg University, DK)*
Michael NIELSEN, *Undergrad St. (Aalborg University, DK)*
Jakob NIELSEN, *Undergrad St. (Aalborg University, DK)*
Thomas KRAUSE, *Undergrad St. (Tech. Univ. of Chemnitz, G)*
Duarte LEÃO, *Undergrad St.*
Hugo COSTELHA, *Undergrad St.*
Gonçalo NETO, *Undergrad St.*
Pedro PINHEIRO, *Undergrad St.*
Miguel ARROZ, *Undergrad St.*
Vasco PIRES, *Undergrad St.*
Tiago FERREIRA, *Undergrad St.*
Paulo GOMES, *Undergrad St.*

COMPUTER AND ROBOT VISION:

João SENTIEIRO, *Full Professor, ISR/IST Director*
José SANTOS-VICTOR, *Associate Professor*
João Paulo S. A. COSTEIRA, *Assistant Professor*
Alexandre BERNARDINO, *Teach.Assist., Ph.D. St.*
José GASPAREL, *Teaching Assistant, Ph.D. St.*
Nuno GRACIAS, *Ph.D. St.*
Etienne GROSSMAN, *Ph.D. Researcher*
João MACIEL, *Ph.D. Researcher*
Plínio Moreno LOPES, *Ph.D. St.*

Manuel LOPES, *Ph.D. St.*
Ricardo OLIVEIRA, *Ph.D. St.*
Roger Alex de FREITAS, *Ph.D. St.*
Nuno Pinho da SILVA, *M.Sc. St.*

EVOLUTIONARY SYSTEMS AND BIOMEDICAL ENG.:

Agostinho ROSA, *Associate Professor*
Fernando MELÍCIO, *Adj. Professor, Ph.D. St.*
Rogério LARGO, *Adj. Professor, Ph.D. St.*
Osvaldo BRASAO, *Ph. D. St.*
Hongfei GONG, *Ph.D. St.*
Cristian MUNTEANU, *Ph.D. St.*
José MALAQUIAS, *Ph.D. St., Teaching Assistant*
Ernesto SOARES, *Ph. D. St.*
João Paulo CALDEIRA, *M.Sc. St., Teaching Assistant*
Rui TAVARES, *M.Sc. St., Teaching Assistant*
Carlos FERNANDES, *M.Sc. St.*
Nelson PEREIRA, *M.Sc. St.*
Ivo BHATT, *M.Sc. St.*
Alexandre CALAPEZ, *M.Sc. St.*
Márcio MOURÃO, *M. Sc. St.*
Henrique PEREIRA, *Research Project*
Paulo SILVA, *Research Project*

Sergio CHIN, *Undergrad St.*
Djamilo JACINTO, *Undergrad St.*
Andre BALTAZAR, *Undergrad St.*
Pedro SOEIMA, *Undergrad St.*
Nuno COSTA, *Undergrad St.*
Fernando CONTREIRAS, *Undergrad St.*
Marco ERRA, *Undergrad St.*
Pedro MITRA, *Undergrad St.*
Carlos Manuel CONCEIÇÃO, *Undergrad St.*
João Fernando COSTA, *Undergrad St.*
Teresa Maria de Andrade ROSADO, *Undergrad St.*
Miguel Reis NAVE, *Undergrad St.*
Paulo Jorge APARÍCIO, *Undergrad St.*
Paulo Sérgio da Silva PAIXÃO, *Undergrad St.*
Miguel Angelo Rodrigues de CARVALHO, *Undergrad St.*
Bruno Ricardo Simões Nogueira e SOUSA, *Undergrad St.*
João Marco Cabral Dias SOUSA, *Undergrad St.*
Diogo GRADE, *Undergrad St.*
Eduardo COUTINHO, *Undergrad St.*
Bruno AFONSO, *Undergrad St.*

Nidia CALDEIRA, *secretary*

MOBILE ROBOTICS :

Maria Isabel RIBEIRO, *Associate Professor, ISR/IST Vice - Director*
João SEQUEIRA, *Assistant Professor*
Ognyan MANOLOV, *Post-Doc*
Alberto VALE, *Ph.D. St.*
Francisco Melo, *Ph.D St.*
Sérgio GUERREIRO, *M.Sc. St.*
José Inácio ROCHA, *M.Sc. St.*
Zlatan TATAROV, *M.Sc St.*

Armando FONSECA, *Undergrad St.*
Luis JORGE, *Undergrad St.*
Ricardo FERREIRA, *Undergrad St.*
Pedro SOARES, *Undergrad St.*
Carlos ALFARO, *Undergrad St.*

SIGNAL PROCESSING: (IST)

Victor BARROSO, *Associate Professor*
Isabel LOURTIE, *Associate Professor*
Jorge S. MARQUES, *Associate Professor*
Carlos BISPO, *Assistant Professor*
Pedro M. Q. AGUIAR, *Assistant Professor*
Francisco GARCIA, *Assistant Professor*
João Pedro GOMES, *Assistant Professor*
João XAVIER, *Assistant Professor*
Paulo M. de OLIVEIRA, *Post-Doc*
Sebastien BAUSSON, *Post-Doc*
Miloud FRIKEL, *Post-Doc*
João SANCHES, *Teach. Assistant, Ph.D. St.*
Jacinto NASCIMENTO, *Ph.D. St.*
Jorge BARBOSA, *Ph.D. St.*
Dusan RAMLJAK, *Ph.D. St.*
Emanuel RIBEIRO, *Ph.D. St.*
Marko BEKO, *PhD. St.*
Pedro JORGE, *Ph.D. St.*
Nuno ORFÃO, *PhD. St.*
Nuno PINHO, *M.Sc. St.*
Paulo LOPES, *M.Sc. St.*
Tiago PATRÃO, *M.Sc. St.*
Tiago BARROSO, *M.Sc. St.*
Rui F. C. GUERREIRO, *M.Sc. St.*

Márcio F. CABRAL, *Undergrad. St*

SIGNAL PROCESSING : (U.ALGARVE)

Sérgio JESUS, *Associate Professor*
Hans du BUF, *Invited Associate Professor*
Hamid SHAHBAZKIA, *Assistant Professor*
Orlando C. RODRIGUEZ, *Assistant Professor*
Ulrich BOBINGER, *Post-Doc*
Mário C. M. JESUS, *Adjoint Professor*
António João SILVA, *Adjoin Professor, Ph.D. St.*
Paulo FELISBERTO, *Adjoin Professor, Ph.D. St.*
Robert LOKE, *Ph.D. St.*

João RODRIGUES, *Ph.D. St.*
Luis SANTOS, *Ph.D. St.*
Pedro GUERREIRO, *Ph. D St.*
Roberto LAM, *Ph. D. St.*
Cristiano SOARES, *Ph. D St.*
Nelson MARTINS, *Ph. D St.*
Filipe TOMAZ, *Research Assistant*
Tiago CANDEIAS, *Research Assistant*

Bruno SILVA, *Undergrad. St.*

DYNAMICAL SYSTEMS AND OCEAN ROBOTICS :

António PASCOAL, *Associate Professor*
Carlos SILVESTRE, *Assistant Professor*
Paulo OLIVEIRA, *Assistant Professor*
Leonel LAPIERRE, *Post-Doc*
Didik SOETANTO, *Post-Doc*
Pedro ENCARNAÇÃO, *Ph.D. St.*
António AGUIAR, *Ph.D. St.*
Rita CUNHA, *PhD. St.*
Francisco TEIXEIRA, *Ph.D. St.*
Fei CHUN MA, *Ph.D. St.*
Sajjad ASL, *Ph.D. St.*
Reza GHABCHELOO, *Ph.D. St.*
João ALVES, *M.Sc. St.*
Rodolfo OLIVEIRA, *M.Sc. St.*
Nuno PAULINO, *M.Sc. St.*
Luis SEBASTIÃO, *Res. Engineer*
Manuel RUFINO, *Res. Engineer*
Guilherme LIBÓRIO, *Technician*

ADMINISTRATIVE STAFF:

Filomena VIEGAS
Loic BAMDÉ
Nuno SENA

AERONAUTICS :

Luis M. Braga da Costa CAMPOS, *Full Professor*
Fernando P. LAU, *Assistant Professor*
Paulo J. S. GIL, *Assistant Professor*
Pedro M. V. MIRANDA MENDES, *Colaborator*

Ana D. MORGADO, *Secretary*

2.2 CURRENT RESEARCH INTERESTS

The Lisbon pole of ISR is internally organized in 7 laboratories/groups. In this section the main research interests of each one of the Laboratories/groups are briefly described.

2.2.1 INTELLIGENT SYSTEMS LAB (IS)

Some of the current problems in Automatic Control (AC) and Artificial Intelligence (AI) are creating a natural trend towards joint research approaches to their solution. One of the most important modern branches of AI is Distributed AI, where the focus is on multi-agent systems, either virtual (e.g., web agents) or with a physical body (e.g., robots), with a special interest on organizational issues, distributed decision making and social relations. On the other hand, AC faces the growing complexity of the actual systems to be controlled, as well as the challenges of integrating design, real-time and operation aspects of modern control systems, many of them distributed in nature (large plant process control, robots, communication networks).

This natural convergence of the research topics in the two areas was the major motivation for the fusion, during 2002, of the former Artificial Intelligence and Manufacturing Systems (AIMS), and Intelligent Control (IC) Laboratories of ISR/IST, under the designation of Intelligent Systems (IS) Laboratory.

The ISlab driving theme is the Research and Development on Multi Robotic Agent Systems and involves the following research topics:

Multi Agent Systems - to study formal modelling tools adequate to develop and organize a team capable of dealing with complex and dynamic environments, working coherently as a group of agents, handling different and even opposite views of the world and the problem within the team, allowing flexible communication among team members, evaluating the team performance and implementing re-organization strategies to handle unexpected situations.

Hybrid and Discrete Event Systems - for robotic task modelling, supervision and coordination, so as to provide means for analysis and synthesis from desired qualitative and quantitative specifications, such as the absence of deadlocks or live locks, unreachable unsafe states, deterministic or probabilistic execution time.

Cooperative Reinforcement Learning - as an approach to iterative stochastic decision making during the coordinated execution of robotic tasks without full knowledge of the environment model, as well as a quantitative evaluation of robotic task performance.

Formation Control and Feasibility - to provide conditions for formation feasibility and to develop controllers that keep the formation, ensure their stability and allow obstacle avoidance.

Emotion-based Agents - to study methodologies for developing emotion-based agents, which is an entity whose behaviour is guided by taking into account first a rough evaluation of a stimulus goodness and badness, and then an identification of the stimulus based on past experiences. A complementary goal for this research is to study how an emotion-based architecture might be articulated with a classical rational-based architecture.

The group is currently interested in applications to *Soccer Robots*, *Rescue Robots*, *Manufacturing Systems*, and *Satellite Formations*.



2.2.2 COMPUTER AND ROBOT VISION (VIS)

The research conducted in the Vislab is organized in two main lines:

- **Vision Based Control and Navigation**
- **3D Motion analysis and Reconstruction**

When a camera is moving in a static (or dynamic) environment, the image sequence conveys information regarding the scene/objects structure and camera/objects motion.

In the theme of **Vision Based Control and Navigation**, we address the fundamental problems of understanding what *relevant* information can be extracted from the image sequences to *control* a robot in order to perform a *given task*. This has long standing research line of the Vislab including the control of extremely varied systems like the active control of a binocular head, vision based navigation for land, aerial and underwater vehicles and teleoperated cellular robots. From the foundation, VisLab has addressed the control of Binocular Systems and a land mobile robots. More recently, the research was extended to vehicles moving in the 3D space, such that the interplay between the vehicle's degrees of freedom and the scene structure is significantly richer. Example applications have focused on lighter than air blimps and underwater vehicles, in the context of European Research Projects. One distinctive aspect is the search for alternative imaging geometries, often inspired after biological findings. Extensive work has been carried out in the domain of using omni directional images for navigation and control as well as for map building for indoors robots. In addition, we have pursued the usage of non-metric maps for navigation like topological maps for structured environments and video mosaics for underwater navigation.

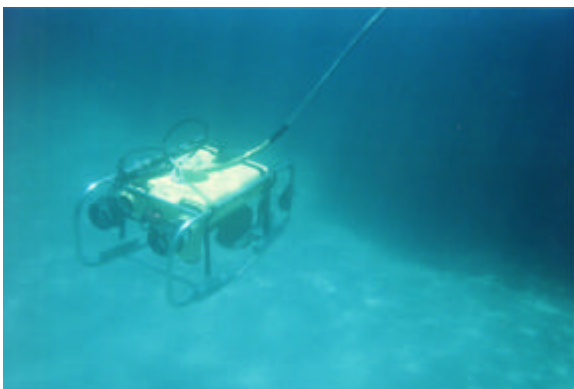
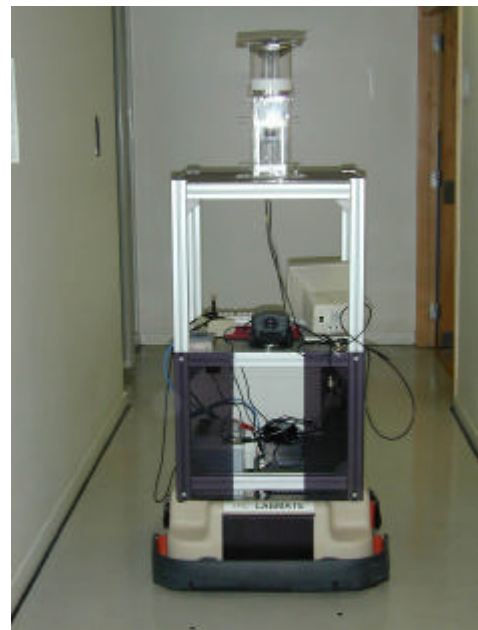
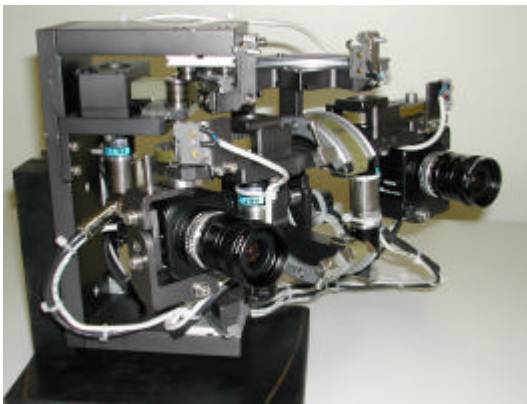

The theme of **3D motion Analysis and Reconstruction** is devoted to the geometry of retrieving information about the scene structure or camera motion from video sequences. Work has addressed the problem of estimating the 3D motion of a camera from an image sequence. Several visual cues were exploited for this purpose: the visual motion and occlusions. Regarding 3D reconstruction, work has focused on developing optimal approaches for matching image features, which is a key step in most 3D vision systems. In addition, the depth estimation process has been formulated in an optimal way by itself. Another line of research has been the reconstruction of structured scenes (e.g. buildings) making use of auxiliary geometric information provided by the user.



Research in all these topics has been carried out both at the level of the fundamental methodologies and also for applications. As the knowledge in these various aspects matures inside the group, research projects have been proposed, including national and European Projects.

2.2.3 MOBILE ROBOTICS (MR)

The Mobile Robotics Lab activities focuses on the research, development and testing of robotic tools applied to the control and navigation of autonomous mobile robotics.

In this Laboratory we are particularly interested in the issues of:

mobile robot navigation, in structured and semi-structured environments,
cooperation/colaboration among multiple robotic devices,
robotics and information systems.

- **Mobile robot navigation:** Study of navigation methodologies for the operation of mobile robots in structure and semi-structured indoor environments, including environment representation, obstacle detection and avoidance, path planning, trajectory finding, motion control and localization. Different sensors are used, namely ultrasound and laser. The group is most interested in the establishment of new sensor and world representations aiming at simplifying the navigation tasks, namely to overcome the absolute localization required in most tasks. The study of probabilistic approaches for the Simultaneous Localization and Map Building, SLAM, in outdoors environment, together with hybrid environment representation, aiming at outdoors operations is currently under study.
- **Cooperative robotics:** Study of the control of multiple heterogeneous robots (mobile platforms and manipulators) acting together towards the fulfillment of an assigned task. Behavior-based approaches to the control of each single robot and multi-robots are considered using tools from algebraic group theory. These led to conceptual control architecture of hybrid nature, with a supervisor modeled by a finite discrete automaton and a set of classes of continuous models modeling robot motion. A distinctive feature of these continuous models is that they accept (in the sense that an assigned mission can be successfully executed) a broad range of robot trajectories. A different addressed issue relates with cooperative navigation and cooperative SLAM.
- **Robotics and information systems:** Information systems are one of the cornerstones of most of the modern organizations. Furthermore, the use of CASE tools in organizations management/operation led to the development of abstract modeling languages of which one of the most widely used is UML (Universal Modeling Language). The biological inspiration has been used in many areas of robotics, such as sensors and robot control architectures. Furthermore, the recent explosion of cooperative robotics is also absorbing paradigms from social evolution models to minimize the complexity of the problem. A similar approach was followed to design a robot control architecture based on a business modeling framework. Unlike the classical approach, this robot control architecture is defined for each mission assigned to the robot and it is revised each time an event in a pre-specified set is triggered. It is also expected that the overall methodology can be applied to robot teams.

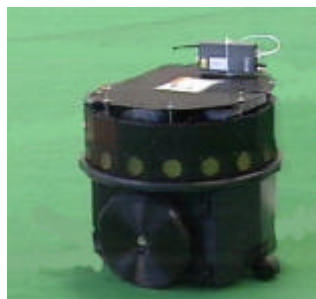

2.2.4 SIGNAL AND IMAGE PROCESSING (SP)

- **Statistical Array and Signal Processing**
- **Wireless Communication Systems**
- **Underwater Acoustic Data Communications**
- **Detection and Estimation Theory**
- **Time-Frequency Signal Analysis and Processing**
- **Navigation and Guidance of underwater vehicles**
- **Image Processing**
- **shape analysis**
- **video surveillance**
- **pattern recognition**
- **Image analysis**
- **Computer vision**
- **Video processing**
- **Multimedia signal processing**

2.2.5 EVOLUTIONARY SYSTEMS AND BIOMEDICAL ENGINEERING (ESBE)

In the last three years a great effort has been directed to the development of the new areas of Evolutionary Computation and Computational Intelligence. An application oriented approach has been the early focus and will remain so, but recently the attention has been more directed towards methodology and paradigm areas. Current research in this new objectives are: Development of algorithms with gene oriented paradigms instead of individual or chromosome centered. New gene oriented crossover and mutation operators (infection operators) have been devised and applied; more applications and general conceptual framework undergoing. The symbiotic/synergetic use of Evolutionary Computation with Artificial Life simulation models (as insect colony optimization, disease simulation and prediction, etc). The initial steps for the application of Evolutionary Computation in the area of Computational Molecular Biology will be taken.

On the Biomedical Engineering area, the core work on sleep research will proceed with international cooperation. The area of cognitive science linked to the EEG as brain computer interface will be the next point of further exploration.

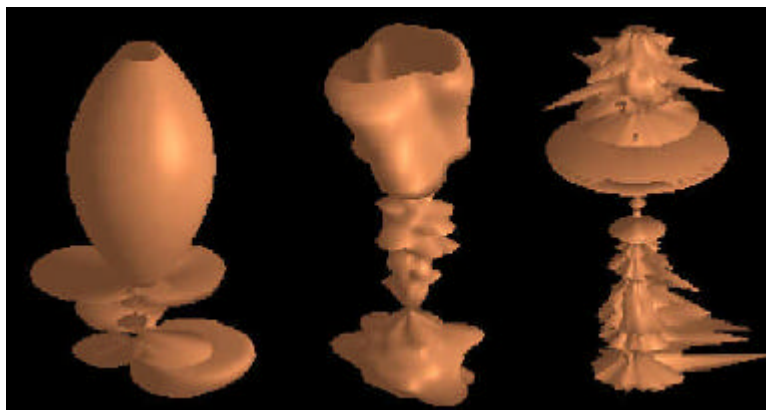

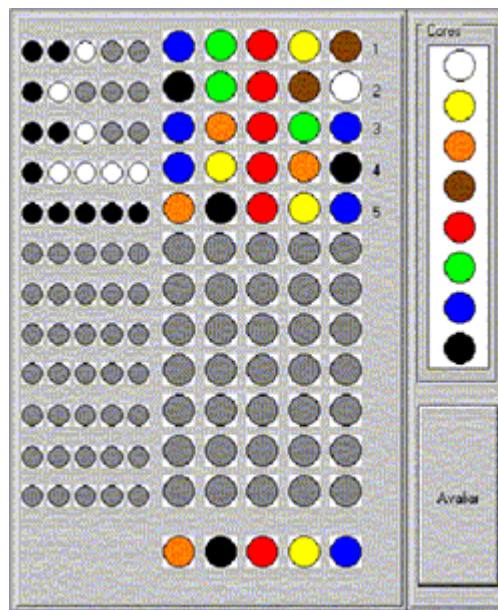

Search Problems Solving using Evolutionary Search

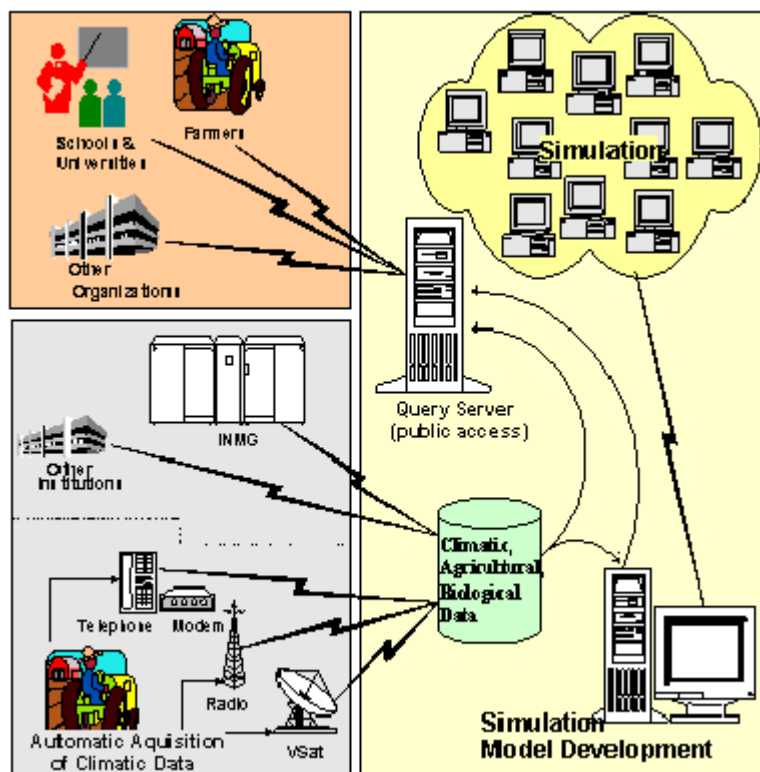

Integrated Protection of Crops Using Artificial Life Simulation

2.2.6 DYNAMIC SYSTEMS AND OCEAN ROBOTICS (DSOR)

The key objective of the research and development work carried out at the Dynamical Systems and Ocean Robotics Laboratory (DSORL) of ISR is twofold: i) contributing to furthering the knowledge in the general area of dynamical system theory, and ii) applying newly developed analysis and design tools in the fields of navigation, guidance, and control to the construction and operation of robotic ocean and air vehicles.

Over the past few years, the *research* work done at the DSORL has been focused on the following areas:

- i) advanced *linear and nonlinear system theory* with applications to the development of new methods for autonomous vehicle navigation, guidance, and control.
- ii) *nonlinear control theory* with applications to coordinated control of multiple autonomous vehicles in the presence of severe inter-vehicle communication constraints.
- iii) study of hybrid systems and related *hardware and software architectures for mission control* of robotic vehicles.

The **development** work has led to the construction of the robotic ocean vehicles DELFIM (an autonomous surface Catamaran), INFANTE (an autonomous underwater robot), and CARAVELA (an autonomous oceanographic vessel). Currently, DSORL participates in the development of the DREAM ROV (remotely operated vehicle), the miniaturized MAYA AUV (autonomous underwater vehicle), and the IRIS (automatic surveying tool). These vehicles and tools play the dual role of i) *advanced testbeds*, to field test new system theoretical concepts and hardware / software architectures for autonomous vehicle control, and ii) *platforms for actual operations at sea*, effectively paving the way for a fruitful symbiosis between marine science and technology. This follows the successful development of MARIUS, the first civilian European autonomous underwater vehicle for coastal oceanography in the scope of a project coordinated by ISR/IST, under the auspices of the Commission of the European Communities. The DSORL has also played an active role in the design, implementation, and at sea testing of the navigation, guidance, control, and mission control systems of SIRENE, an underwater shuttle for the automatic deployment of benthic laboratories developed in the scope of a European project coordinated by IFREMER, France.



DELFIN Autonomous Surface Craft (ASC): vehicle launching and operation at sea

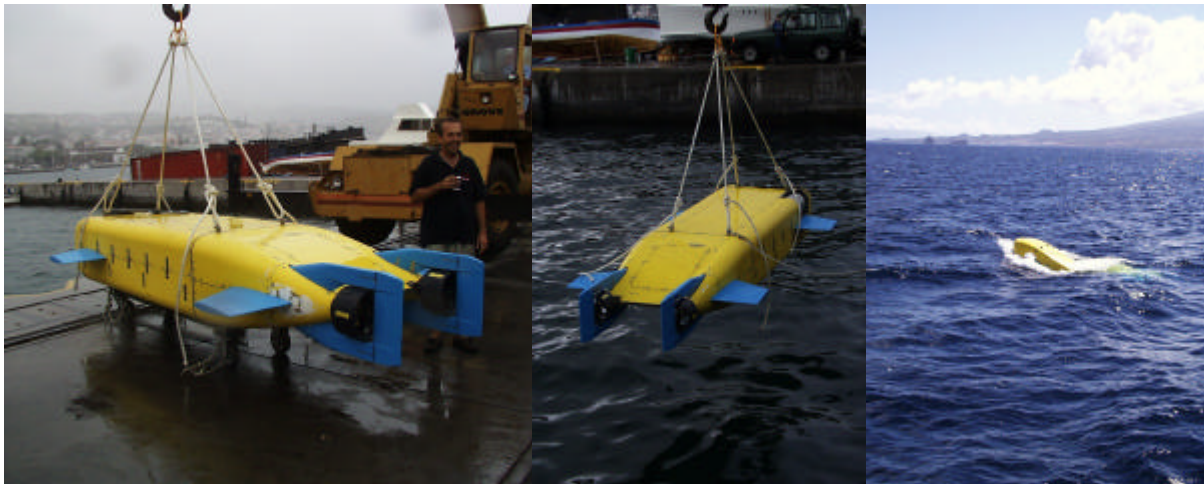

The INFANTE Autonomous Underwater Vehicle during a mission at sea in the Azores – in cooperation with the IMAR/DOP/University of the Azores (Summer of 2002)

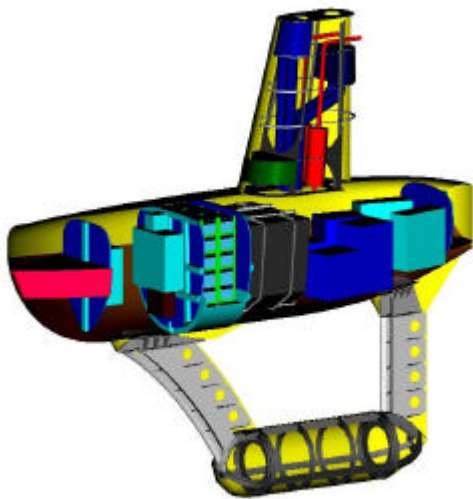

The CARAVELA Autonomous Surface Craft (ASC): CAD figure and scaled down model (to be launched in April 2003)

Currently, the DSORL is involved in a number of projects and concerted actions with national and foreign institutions with the objective of advancing engineering methodologies and equipments to the point where they can be used as versatile tools to expand our understanding of the oceans. Representative institutions include the Naval Postgraduate School of Monterey, CA (USA), the Istituto Automazione Navale, Genova (Italy), the National Institute of Oceanography, Goa (India), the Department of Electrical Engineering of the University of Genova (Italy), the IMAR/DOP/UAçores - Department of Oceanography and Fisheries of the University of the Azores (Portugal), the CREMINER Center of the Faculdade de Ciências da Universidade de Lisboa (FCUL), the Instituto Geológico e Mineiro (Geological Survey of Portugal), and the Laboratório Nacional de Engenharia Civil (Portugal). Privileged links have been established with the IMAR / DOP / UAçores and CREMINER / FCUL, under Theme A (Techniques



The X-treme model helicopter of the DSORL

for Ocean Exploration) of the recently formed Laboratório Associado (Associated Laboratory) coordinated by the ISR.

At a technological level, this concerted effort is in line with the current trend worldwide, aimed at the development of ocean sampling networks (OSN) providing a nested ocean observation capability through the coordinated control of many, mobile, networked, sensor platforms. This trend shows clearly that advancements in marine robotics, communications, and information systems are steadily being brought to bear on the development of technologies to enable safer, better, faster, and far more efficient methodologies for the study of the oceans. At the same time, the plethora of engineering problems that must be tackled and solved in the context of ocean research pose considerable challenges to theoreticians and system designers.

Recently, as a natural consequence of a longstanding collaboration program with the Department of Aeronautics and Astronautics of the Naval Postgraduate School of Monterey, California, USA, the DSORL has started to apply some of the methodologies and technologies developed for ocean vehicles to the control of air robots (helicopters). This is justified in view of the increasing interest worldwide in the use of unmanned aerial robotic vehicles to perform airborne surveying tasks. As part of this effort, the DSORL is developing an unmanned robotic helicopter that will serve as an advanced platform for NGC (navigation, guidance, and control) system design, implementation, and testing. The platform is based on an industrial radio controlled helicopter that is being equipped with a distributed real time computing network, a reliable wireless communication system, and sensing devices. The activity pursued in this area is well rooted in scientific applications that require the use of autonomous air robots to accurately map coastal areas subjected to erosion using airborne laser altimetry

At a *theoretical* level, the main lines of research that are being pursued at the DSORL are the following:

Control of Nonholonomic and Underactuated Vehicles: pose (that is, position and attitude) stabilization of underactuated ocean robots in the presence of unknown ocean currents, actuator saturation, and vehicle parameter uncertainty using Lyapunov-based techniques, back stepping, and switched hybrid control.

Trajectory Tracking and Path Following Control (development of linear and nonlinear control strategies for accurate trajectory tracking /path following of ocean and air vehicles). *Linear designs* build on gain-scheduled control theory and exploit the use of Linear Matrix Inequalities. *Nonlinear designs* resort to Lyapunov based back stepping techniques and address the problem of parameter uncertainty explicitly. Emphasis has been placed on the development of innovative methods for the design of path following controllers that deal directly with vehicle dynamics and overcomes stringent initial condition constraints that are present in a number of path following control strategies described in the literature. This is done by controlling explicitly the rate of progression of a "virtual target" to be tracked along the path, thus by passing the "singularity" problems that arise when the position of the virtual target is simply defined by the

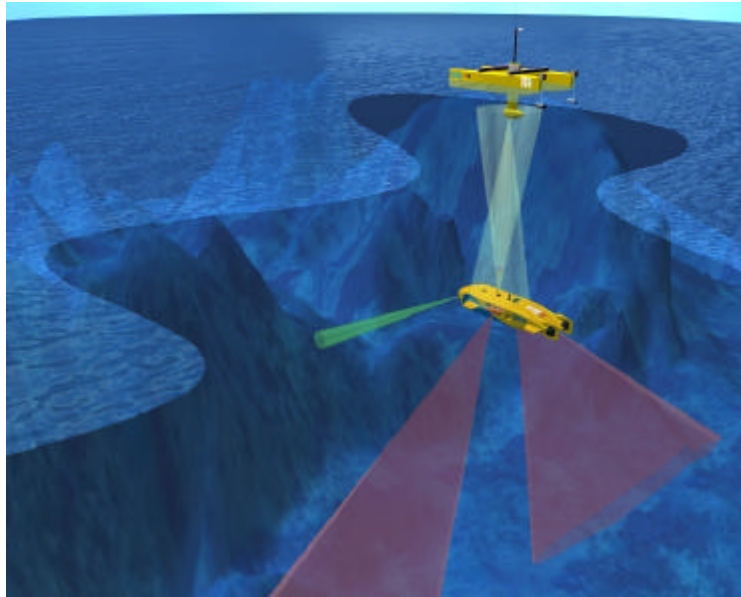

Combined autonomous surface craft / autonomous underwater vehicle control.

projection of the actual vehicle on that path. *Work along these lines is also being done towards the development of sensor-based path following control laws for ocean vehicles using vision and sonar, in cooperation with the VISLAB of ISR.* The prototype vehicles available at the DSORL are proving instrumental in bridging the gap between theory and practice, effectively providing the means to go from algorithms to tests at sea. Path following controllers for the DELFIM autonomous surface craft have been thoroughly tested during missions in the Azores.

Coordinated Vehicle Control (multiple vehicle control for the execution of joint missions at sea). There is currently considerable interest in the problem of coordinated motion control of fleets of autonomous vehicles. Examples include formation flying control, spacecraft formation control, coordinated control of wheeled mobile robots, and control of multiple marine craft, including surface and underwater vehicles. The work reported in the literature addresses a large class of practical problems that include, among others, leader following and control of the center and radius of dispersion of a swarm of vehicles. The work being pursued at the DSORL addresses the special problem of coordinated motion control of marine craft that arises when both vehicles are required to follow two identical paths where one is a spatially shifted version of the other. The rationale for this problem can be best understood by referring to a number of practical mission scenarios:

1. *Combined autonomous surface craft / autonomous underwater vehicle control.* In this scenario, an autonomous surface craft (ASC) is required to follow a desired path accurately while an autonomous underwater vehicle (AUV) operating at a fixed depth is required to follow exactly the same horizontal path (shifted in the vertical coordinate), while tracking the ASC motion along that path. See the joint figure. In this example, the AUV serves as a mobile sensor suite to acquire scientific data, while the ASC plays the role of a fast communication relay between the AUV and a support ship. Thus, the ASC effectively explores the fact that high data rate underwater communications can best be achieved if the emitter and the receiver are aligned along the same vertical line. Notice how both vehicles are required to follow exactly the same type of path, which is imposed by the scientific missions at hand.

2. *Combined autonomous underwater vehicle control: image acquisition.* This scenario occurs when an underwater vehicle carries a strong light source and illuminates the scenery around a second underwater vehicle that must follow a pre-determined path and acquire images for scientific purposes.

3. *Combined autonomous underwater vehicle control: fast acoustic coverage of the seabed.* In this important case, two vehicles are required to fly above the seabed at the same or different depths, along parallel paths, and map the seabed using two copies of the same suite of acoustic sensors (e.g. sidescan, mechanically scanned pencil beam, and subbottom

profiler). By requesting the two vehicles to traverse identical paths so as to make the acoustic beam coverage overlap on the seabed, large areas can be covered in a fast manner.

In all cases, one of the vehicles (leader) follows a path and the second vehicle (follower) is required to track the first one. A cursory analysis of the problem seems to indicate that a solution is at hand once a path following and a trajectory controller have been found for the leader and the follower vehicle, respectively. However, the problem is far more complex than a simple analysis suggests. Consider the first mission scenario, where the (leader) surface vehicle may deviate from its planned path due to wind, currents and wave action. In this case, scientific mission requirements dictate that the underwater vehicle (that is much less susceptible to external disturbances) remain on the nominal path adopted, and that while on that path it should maneuver to stay in the vicinity of the leader in order to not lose the fast vertical communications link. A solution to this problem appeared for the first time in the PhD thesis of Pedro Encarnação, a member of the DSORL. However, the control law derived suffers from two major drawbacks: i) it requires the computation of trajectory tracking controllers for both vehicles, and ii) the large amount of information to be exchanged between the two vehicles makes it hard to apply in practice, due to the absence of a high data rate underwater acoustic link. Work is not being pursued to lift these restrictions. Encouraging results have been obtained by exploring some of the ideas explored for path following, by considering two “coordinated virtual targets” moving along the paths.

Navigation System Design: new methods for navigation system design are being developed using the theory of multi-rate, polytopic, and linear parametrically varying systems. The main goal is to develop methodologies that can afford system designers with frequency-like design / analysis tools, thus extending to the time-varying and nonlinear setting the highly practical and intuitively appealing complementary filtering structures. Some of the algorithms developed have been tested at sea during missions with the Delfim autonomous surface craft. Current work addresses the problem of autonomous underwater vehicle (AUV) navigation by complementing inertial sensor data with that available from a set of acoustic sensors. These include a Doppler unit and a position system that relies on a set of free floating buoys equipped with GPS receivers and hydrophones for the reception of acoustic signals emitted by the AUV. In order to better grasp the scope of the problems involved in the design of practical navigation systems, the design of an Inertial Navigation System and its fusion with a GPS receiver were carried out, based on an inexpensive sensor suite. An Attitude and Heading Reference System was also developed. Both systems were designed and implemented using some of the navigation algorithms and specific hardware for real time distributed systems developed at the DSORL.

The research activity in this area witnessed also the development of vision-based nonlinear complementary filtering structures for air and undersea applications. Recently, work was started on the development of algorithms for feature-based navigation. Namely, terrain based navigation and navigation based on magnetometry. The ideas being explored borrow from the field of SLAM (Simultaneous Localization and Mapping). *Exploratory steps in this direction were taken in cooperation with the VISLAB of the ISR, where underwater images acquired around the island of Faial were processed to obtain mosaics so as to characterize the types of feature aids that can be used for navigation.*

Mission Control Systems (MCSs) : at the mission control level, work has continued on the development of software and hardware tools for mission programming and mission execution of autonomous vehicles, including cooperative control of surface and underwater vehicles. This work has been instrumental in enhancing the capabilities of the Petri-net based software application named CORAL, proprietary of ISR/IST. At the same time, hardware architectures continued to be developed for distributed real-time control of ocean robotic vehicles. Intensive series of tests at sea showed the reliability of the overall Mission Control System (MCS) developed. During the summer of 2002, the DELFIM ASC successfully completed a series of seabed map building missions under the supervision of its MCS. During these missions the vehicle performed a grid survey around the island of Faial, executing path following maneuvers in the presence of shifting sea currents and wind, while collecting acoustic data from a sidescan and mechanically scanning pencil beam sonar. The data were later processed to obtain high resolution seabed (bathymetric maps). During the same period, the INFANTE AUV was operated in the canal between the islands of Faial and Pico in an autonomous mode, using the same type of MCS.

The implementation of all theoretical algorithms / strategies for vehicle and mission control in the prototype vehicles described above requires the availability of **Real Time Distributed Control Systems and Control Networks**. In fact, the use of distributed systems in real time control architectures for vehicular applications holds the key to the development of field robots capable of operating reliably in non-structured environments. Real time distributed control plays a major role in the development of vehicle command and control structures, flight control systems, and large in situ data acquisition systems. With the increase in hardware computing capabilities and the decrease in

power consumption, it is now possible to use distributed computing and data manipulation architectures in Autonomous Vehicles where

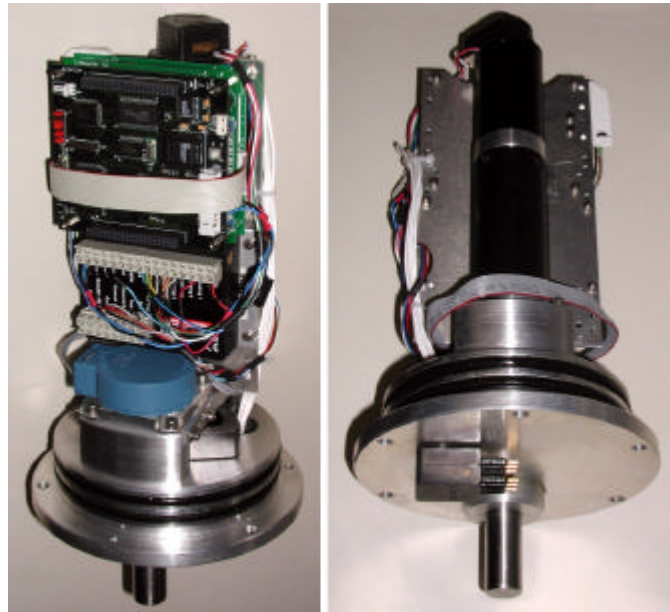

Surface actuator for the INFANTE AUV
(a node of the Distributed Control System installed on-board)

power consumption, reliability, and robustness impose drastic limitations on overall system design. To keep abreast with recent developments and to ensure reduced costs, reduced power consumption, and increased reliability of all computational systems installed on board the prototype vehicles operated by the DSORL, a CAN BUS based real time distributed architecture has been developed and used in the operation of the DELFIM and INFANTE autonomous vehicles at sea. The architecture continues to be upgraded as the need to integrate powerful computational nodes arises. As an example, the joint figure shows a surface actuator for the INFANTE AUV developed at the DSORL, rated for 600-meter depth. The actuator is simply viewed as a node in the distributed control system installed on board. In the figure, the stack with cards for I/O, CAN BUS interfacing and data processing is visible.

Cooperation with other ISR Laboratories

During the year 2002, DSORL has explored collaboration links with other Labs of ISR. Namely, the DSORL has participated in the following lines of research:

- Marine Craft Control using Image and 3D Shape Matching (with *VISLAB*) – joint supervision of an MSc. thesis.
- Landmark Based Underwater Navigation – the *VISLAB* contribution focused on video mosaicking from video images acquired around the island of Faial, in the Azores.
- Terrain Following of Unmanned Air Vehicles (with the *Mobile Robotics Lab*) – joint work on “Terrain following preview controllers for model-scale helicopters”.
- Underwater Communication Systems (with the *Signal Processing Lab*) – the DSORL Lab is responsible for the integration and testing at sea of the acoustic modems that were developed by the French company ORCA for the INFANTE AUV, by exploring a fruitful partnership with the Signal Processing Lab of ISR.

2.2.7 AERONAUTICS (AERO)

In Aeronautics:

- Flight testing, including development of instrumentation packages;
- Flight dynamics, including non-linear stability and atmospheric effects;
- Flight simulation: installation of a three degree-of-freedom simulator;
- Aerodynamics: installation of an aero acoustic wind tunnel.

In Acoustics:

- Sound generation by aircraft propellers and helicopter rotors;
- Sound propagation in ducts of varying cross-section with flow (nozzles);
- Scattering of sound in shear flows, including boundary layers and shear layers.

In Magnetohydrodynamics:

- Hydromagnetic waves in inhomogeneous and flowing media;
- Applications to solar atmosphere and wind.

In Applied Mathematics:

- Differ integration, i.e. derivatives and integrals of non-integer order;
- Special functions, i.e. extensions of the hyper geometric type;
- Ordinary differential equations with regular and irregular singularities.

3. RESEARCH ACTIVITIES

3.1 RESEARCH PROJECTS

This section contains a brief description of the R&D projects in progress at ISR (Lisbon), IST and University of Algarve during 2002, under the supervision of ISR members. The subsections define the main areas of intervention where the projects are being developed. The projects resulting from contracts celebrated with ISR and managed by this private research institution are identified by (*) on the title; all the remaining projects refer to contracts celebrated and managed by IST and University of Algarve.

3.1.1 UNDERWATER AND OCEAN ROBOTICS

Project name: AUTONOMOUS VEHICLE DESIGN AND CONTROL

Project Leader within ISR: Prof. António Pascoal (IST/ISR)

Project Description: The objective of this research program is twofold: i) to develop methods for integrated design of underwater vehicles and dynamic controllers, and ii) to study new methodologies for guidance and control of autonomous robotic vehicles, including those subject to nonholonomic constraints. The main thrust of the research effort addresses the following topics:

i) Integrated design of underwater vehicles and controllers - the methodologies explored are firmly rooted in the field of control systems theory and borrow heavily from the areas of Linear Matrix Inequalities (LMIs) and Convex Optimization, which are the subject of current research.

ii) AUV control under wave disturbances - the main theoretical tools used are stochastic linearization and linear matrix inequalities. The first allow computing the "linear simplified model" of a full stochastic model for the AUV; the latter are specially suited to address multiobjective design criteria such as minimizing the effect of wave action while maintaining sufficient control authority for depth maneuvering and robustness against plant uncertainty.

iii) Path following in 3-D - the key issue in this research topic is the control of air and ocean vehicles for accurate path following in 3-D. The methodologies being used borrow from Lyapunov stability theory.

iv) Control of nonholonomic vehicles - new methodologies are being explored to design nonlinear controller for nonholonomic vehicles for stabilization to a point with a desired orientation. The work has focused on the design of hybrid control systems that rely on the switching of a finite set of controllers, driven by the occurrence of observable external events.

v) Control of surface craft using acceleration feedback - the problem addressed is that of designing acceleration feedback control systems for precise maneuvering and wave disturbance attenuation of hydrofoil craft. The design methodologies explore simple key physical relationships and build on gain scheduling control techniques.

Research Areas: Combined Plant / Controller Optimization, Control Theory, AUV Dynamics, Linear Matrix Inequalities.

Laboratories: DSORL

External Partners: Dept. Mechanical Engineering and Dept. Aeronautics and Astronautics, Naval Postgraduate School, Monterey, California, USA; National Institute of Oceanography (NIO), Dona Paula, Goa, India.

Initiated: 1996.

Conclusion : on going

Classification: Memorandum of Understanding between the ISR/IST and the NPS. Memorandum of Understanding between the National Institute of Oceanography and the ISR/IST. Research work supported by NATO scholarships and institutional funding for travel and accommodations.

Documents produced in 2002: [6] , [7] , [8] , [30] , [60] , [61] , [62] , [67] , [67] , [68] , [134] , [135] , [143] , [146] , [147] , [151] , [154] , [155]

Project name: CARAVELA - DEVELOPMENT OF A LONG RANGE AUTONOMOUS OCEANOGRAPHIC VESSEL

Project Leader within ISR: Prof. António Pascoal (IST/ISR)

Project Coordinator: IMAR / University of the Azores (PT).

Project Description: The objectives of the project are to design, develop, and test the systems that are required for the operation of a long range autonomous oceanographic vessel. This is an innovative concept worldwide. The project addresses a wide range of issues that include: i) vehicle design, ii) propulsion, iii) communications, iv) obstacle detection and avoidance, v) navigation, and v) advanced systems for vehicle and mission control. In a representative mission scenario the vehicle will be required to traverse a specified area and collect and transmit selected oceanographic data to a support unit. The vehicle can be operated in a fully autonomous mode. However, its mission can be changed via high level commands issued from a laboratory installed on-shore. The project partners include the Portuguese companies RINAVE and CONAFI in charge of naval engineering aspects and vehicle construction, respectively. These companies are expected to promote the utilization of the vehicle by scientific and commercial entities, and to explore the possibility of its commercialization.

Research Areas: Navigation, Guidance, and Control, Communications, Obstacle Detection and Avoidance, Mission Control of Autonomous Vehicles, Ocean Robotics.

Laboratories: Dynamical Systems and Ocean Robotics Lab (DSORL)

External Partners: RINAVE Registro Internacional Naval (PT), Instituto Superior Técnico / Institute for Systems and Robotics (PT), CONAFI (PT), System Technologies (UK), SIMRAD (NO).

Initiated: October 1998.

Conclusion : (Launching of the vehicle): 2003.

Classification: Programmes PRAXIS XXI (PT) and EUREKA (Commission of the European Communities).

Documents produced in 2002: [6] , [7] , [151] , [156]



Project name: FREESUB - Autonomous Underwater Vehicle for Sub sea Intervention

Project Leader within ISR: Prof. António Pascoal (IST/ISR)

Project Coordinator: Cybernetix Offshore Department, France.

Project Description: The “FREESUB” network addresses the exchange of human resources that are essential to the development of autonomous unmanned sub-sea vehicles (AUVs) for remote intervention on fixed underwater structures. The network’s goal is to aid mobility of scientific researchers, technology transfer, and dissemination of information. The “FREESUB” network fosters the exchange of young doctoral and post-doctoral researchers among various EU universities and research institutes. The main technical objective of the project is to develop general tools that will (in the near future) allow autonomous vehicles to navigate to target sites with great precision and to carry out intervention tasks on underwater fixed structures.

Research Areas: Navigation, Guidance and Control of Marine Vehicles

Laboratories: Dynamical Systems and Ocean Robotics Lab (DSORL)

External Partners: CEA Teleoperation and Robotics Department (F), Democritus University of Thrace (Gr), The Joint Research Centre of the European Commission (I), Instituto Superior Técnico (P), University of Southampton (UK), UKIFREMER (F).

Initiated: October 2000

Conclusion : October 2003; extension requested till October 2004.

Classification: Human Potential Research Training Network No. HPRN-CT-2000-00032

Documents produced in 2002: [60] , [65] , [145] , [151]

Project name: MAROV (*) - Mapping of Marine Habitats in the Azores using Robotic Vehicles

Project Leader within ISR: Prof. António Pascoal (IST/ISR)

Project Coordinator: ISR

Project Description: This project puts forward the concept of marine habitat mapping using an autonomous surface vehicle (ASV) and an autonomous underwater vehicle (AUV) equipped with acoustic and vision systems. The ASV allows for the mapping of large areas of the seabed (albeit with low resolution) using acoustic sensors. Furthermore, it acts as an interface between the AUV and a support ship. The AUV is used for higher resolution acoustic mapping, ocean data acquisition, and video and photo image taking closer to the seabed. Data obtained by the two vehicles and other complementary “classical” sources (for example, divers or towed systems) will be geo-referenced, analyzed by marine geologists and biologists, and processed to generate composites of benthic ecosystems using a Geographic Information System (GIS).

Research Areas: Marine Habitat Mapping Techniques

Laboratories: Dynamical Systems and Ocean Robotics Lab (DSORL)

External Partners: IMAR and Department of Oceanography and Fisheries, Univ. Azores, IGM – Geological Survey of Portugal.

Initiated: December 2000

Conclusion : December 2003

Classification: PDCTM, FCT (PT)

Documents produced in 2002: [6] , [7] , [8] , [30] , [61] , [62] , [63] , [65] , [68] , [134] , [135] , [143] , [146] , [147] , [151] , [155] , [158] .



Project name: DREAM (*) – DEVELOPMENT OF A “SEMI-DEEP” ROV FOR SCIENTIFIC APPLICATIONS AND ENVIRONMENTAL MONITORING.

Project Leader within ISR: Prof. António Pascoal (IST/ISR)

Project Coordinator: IMAR / Laboratório da Guia, Cascais, Portugal

Project Description: The objective of the present project is the development of a **Remotely Operated Vehicle** capable of “semi-deep” intervention (down to the 1000m range) to be used by the Portuguese scientific community in a variety of ocean research missions. Such a vehicle will allow for the investigation of a group of poorly known environments, including the Portuguese continental shelf, where the large majority of national fisheries are deployed, and the upper “levels” of the different canyons that cut into the Portuguese platform and that condition the Portuguese bathial environments to a high extent. “Off the shelf” vehicles can be found, capable of operating down to the proposed depth range, but none with the type of specifications needed for **environmental observation and monitoring**, namely in what relates to accurate positioning and work capacity – sensors and probe installation, sampling gear, video signal processing, etc.

The key technical contribution of the project is the enhancement of a basic ROV structure to enable precise vehicle navigation, guidance, and control as well as acoustic and vision data acquisition, pre-processing, and transmission to a support ship. This will enable maneuvering the ROV along pre-determined searching paths without tight human supervision. Furthermore, it will endow scientific end-users with the capability to survey the ocean floor with great precision by acquiring, among other, side-scan, video, and photo images that are accurately time and position tagged, allowing for mapping of the sea-floor. The user is thus relieved from the tedious and often unsuccessful task of trying to achieve precise vehicle control, namely in the presence of sea currents, effectively shifting the focus of the whole operation to scientific data assessment and overall mission control.

Another objective of the project is the possibility of applying a new concept by developing a “modular” vehicle, capable of being reconfigured for different purposes and mission scenarios. Indeed, no vehicle will meet directly the need of different “configuration” levels, enabling its use from different vessels and at a variety of depth ranges – from “shallow” intervention (c.a. 400m) onboard light vessels of “opportunity” to “deep” diving (down to c.a. 1000m) from a dedicated ship – and a quick “response time” to solicitations such as unpredictable environmental phenomena (e.g. submarine eruptions, spills or other accidents).

The proposing team brings together to the core of the project complementary expertises:

- the technical competence to develop such a vehicle from a brand system (ISR-IST);
- the experience of operation of ROV’s in the Portuguese environments (IMAR-LMG, CREMINER);
- and the capacity to operate the vehicle at sea under a wide range of different conditions (IH).

This is an important step in the development of collaborative ventures between science and technology, where either of the two components directly depends on the contribution from the other. The concept also opens the possibility of addressing specific needs of end-users, including social concerns, namely relating to natural resources management. Finally, the proposal includes the execution of specific surveys at sea. This will allow for the actual testing and demonstration of the vehicle capacities, both in its original configuration and after project development.

Research Areas: Marine Habitat Mapping Techniques

Laboratories: Dynamical Systems and Ocean Robotics Lab (DSORL)

External Partners: IMAR and Department of Oceanography and Fisheries, Univ. Azores, IGM – Geological Survey of Portugal.

Initiated: December 2000

Conclusion : December 2003 (an extension is being requested till December 2004)

Classification: PDCTM, FCT (PT)

Documents produced in 2002: [6] , [8] , [60] , [63] , [68] , [134] , [135] .



Project name: **SUMARE – SURVEY OF MARINE RESOURCES**

Project leader within ISR: Prof. Isabel Lourtie, Prof. José Santos –Victor (IST/ISR)

Project description: The goal of SUMARE is to prove the utility of autonomous sensors for environmental monitoring, showing their efficiency in providing to the competent authorities the data required to guarantee a safe and sustainable exploitation of natural resources. Besides obvious savings in terms of time and costs associated with the use of oceanographic ships, autonomous sensors offer the possibility of :

- (i) adaptively selecting the regions to be sampled in response to observed data;
- (ii) exploiting the morphological characteristics of the sampled field to improve accuracy and consistency.

The project’s work program assesses the multi-disciplinary issues underlying these goals: environmental knowledge modelling, data fusion, sensing and guidance. Its results will be tested in two marine applications :

- (i) monitoring of the evolution of sand banks and
- (ii) mapping of living/dead maerl.

The work program of the project is articulated around the main issues contributing to the design, implementation and use of autonomous intelligent sensors for monitoring applications. Use of existing knowledge concerning the macroscopic behaviour and physical constraints of a natural field can considerably increase data gathering efficiency, by enabling, in real-time, to use the measurements already acquired (or those of correlated parameters) to predict the most interesting or informative regions. For each application considered in the project, existing data, physical models and heuristic rules, will be used to identify mathematical prediction and extrapolation models for real-time guidance of the sensors. Moreover, monitoring efficiency is also increased by concentrating resources on optimizing those performance indexes that reflect the actual needs of the post-processing stages of the acquired data. The project will study the problem of translating specific user needs in performance criteria and associated observation strategies,

with the following guideline: data does not need to be better than the requirements imposed by its ultimate utilization. To effectively use prior knowledge while optimizing relevant performance criteria, the sensors must have sensing modalities and guidance laws enabling on-line execution of adaptive observation strategies. The project will develop the advanced sensing and guidance techniques required by the two kinds of applications considered.

Two true-size at-sea data acquisition campaigns will be used to evaluate the project's results in terms of facility of deployment, efficiency, accuracy, and cost. These campaigns will be conducted using two underwater platforms already existing in participating laboratories modified to fit their needs. The association to the consortium of a User Group, whose role is to follow its developments will provide critical input in terms of other application domains.

Research Areas: Signal Processing, Navigation, Computer Vision

Laboratories: Signal and Image Processing Lab, Vislab - Computer Vision Lab

External Partners: Management Unit of the North Sea Mathematical Models (B), International Centre for Island Technology – Heriot-Watt University (UK), I3S (Laboratoire *d'Informatique, Signaux e Systèmes de Sophia Antipolis* – CNRS- Université de Nice Sophia Antipolis) (FR), Thomson Sintra ASM (FR).

Initiated: 2000

Expected conclusion: 2003

Classification: IST Project , IST-1999-10836

Documents produced in 2002:

3.1.2 COOPERATIVE ROBOTICS

Project name: **SocRob** – Society of Cooperative Robots

Project leaders: Prof. Pedro Lima, Prof. Luis Custódio (AIMS Lab)

Project description: This project fosters general research on multi-agent robotic systems, aiming at introducing methodologies for task planning, task allocation and teamwork supervision/coordination, driven by results from Distributed AI, Hybrid Systems and Discrete Event Systems theory. Its current case study is on Soccer Robots, with regular participations in RoboCup.

Research Areas: Cooperative Robotics, Sensor Fusion, Multi-Agent Systems, Teamwork, Discrete Event Systems.

Laboratories: Intelligent Systems Lab

External Partners:

Initiated: January 1997

Expected Conclusion: undefined

Classification: ALCATEL, FESTO / Mota & Teixeira, ICEP Portugal.

Documents produced in 2002: [18] , [31] , [32] , [74] , [136] , [137]



Project name: **COOPERA** - COOPERATION AMONG MULTIPLE ROBOTIC DEVICES

Project leader: Prof^a Maria Isabel Ribeiro (IST/ISR)

Project description: This project aims at developing and testing an architecture for cooperation among multiple robotic devices acting in cooperation in complex, dangerous, or not accessible environments. A mobile platform with a manipulator mounted on top of it is an example of two combined robotic devices. During the execution of some tasks it is necessary to establish cooperation between them in order to deal the existing constraints, e.g., the physical connection.

A population of several of these combined devices may also be pointed out as an example where cooperation may emerge. Consider, for instance, the transportation of an object of large dimensions by multiple mobile manipulators, acting in cooperation. For simple robotic devices, i.e., devices with a small number of degrees of freedom (dof), design methodologies for global task controllers are known. Systems with multiple robots may be considered as a single robot with multiple dofs. The immediate extension of these methodologies for robotic devices with a large number of degrees of freedom leads to a rapid increase in the computational complexity of the algorithms, making them useless for real time applications.

This project addresses the latter problem by developing an architecture where, instead of dealing with the overall system as a whole, a decoupling methodology supports the cooperation, i.e., the information interchange among the various robots. The architecture to be developed leads to a cooperative behaviour among a set of robots working towards a common goal and is modular, in the sense that it supports, with no major changes, any number of devices. Also, the decision mechanism under the architecture will be carried out at the level of each device, avoiding centralized decision making modules. The architecture is supported by a separation principle between the controllability properties of each robot, considered as an isolated entity, and those of the global system. Non linear control theory leads a major role in this area. The addressed problem is relevant because task execution in large workspaces often require robotic mechanisms combining locomotion and manipulation capabilities. In addition, complex tasks or tasks executed in complex environments may determine that more than one robotic device work together, in cooperation, to fulfill the task.

This application, points out two major advantages in the use of multiple robotic devices over the single robotic devices: simultaneous cover of a larger workspace area, and redundancy, making multiple robot systems robust to device failures and environment uncertainties.

Research Areas: Cooperation of robotic devices

Laboratories: Mobile Robotics Lab

External Partners:

Initiated: February 1997

Conclusion: December 2002

Classification: PRAXIS 2/2.1/TPAR/2087/95

Documents produced in 2002:



Project name: SACOR – SEMI-AUTONOMOUS COOPERATIVE ROBOTS

Project leader within ISR: Prof. João Sequeira (IST/ISR)

Project description: This projects aims at developing a distributed architecture to control multiple robots cooperatively, executing realistic missions with the help of human specialists. Foreseen practical applications include the assistance to the elderly and handicapped and remote surveillance and maintenance.

This project addresses the following topics:

- (1) Synthesis of motion strategies (actions) using Viability Theory;
- (2) Hybrid representation of the team state, with the discrete part of the state including event information exchanged among robots and specialists, and the continuous part of the state including the actions;
- (3) Properties relevant from the mission execution perspective, namely controllability and stability, in the context of the hybrid systems addressed in topic (2).

Topic (1) discusses the influence of uncertainty in the synthesis of each of the robot's actions by selecting classes of controllers that make a differential inclusion (the action) viable in some pre-assigned set (the set bounding the possible trajectories in the robot's C-space).

Topic (2) addresses the formal aspects of joining the relevant issues in viability theory with those in hybrid systems theory.

Topic (3) addresses the effect of negotiation models in team controllability and stability and on the formation of coalitions.

Research Areas: Cooperation of robotic devices

Laboratories: Mobile Robotics Lab

External Partners:

Initiated: September 2002

Conclusion: September 2005

Classification: POSI/SRI/40999/2001

Documents produced in 2002:



Project name: **RESCUE** – Cooperative Navigation for Rescue robots

Project leader: Prof. Pedro Lima

Project description: This project fosters research on multi-agent robotic systems for search and rescue operations as its long-term goal. Currently, the project is focussed on obtaining new results on outdoors perception and navigation, both for individual and cooperative robots.

Research Areas: Distributed Continual Planning, Robotic Task Coordination, Cooperative Navigation, Cooperative Perception, Vision-Based Topological Mapping

Laboratories: Intelligent Systems Lab, Computer Vision Lab, Mobile Robotics Lab

Initiated: November 2000

Expected conclusion: November 2004

Classification: POSI/33293/SRI/2000

Documents produced in 2002: [92]

3.1.3 EDUCATIONAL ROBOTICS

Project name: **RODITAS III** – Robô Didático para Técnicos de Automação de Sistemas

Project leaders: Prof. Pedro Lima (IST/ISR)

Project description: This is an educational project aiming at promoting the experimental teaching of science and technology at high schools. The students learn electronics and mechanics while building a small LEGO robot.

Research Areas: N/A

Laboratories: Intelligent Control Lab

External Partners: INETE – Instituto de Educação Técnica (Technical High School)

Initiated: January 2001

Expected Conclusion: July 2002

Classification: Agência Nacional para a Cultura Científica – Ciência Viva P-IV-351

Documents produced in 2002:

Prototypes :

3.1.4 IMAGE PROCESSING

Project name: TMO - Tracking of Moving Objects with Trained Multi-Models

Project Leader within ISR: Prof. Jorge Salvador Marques

Project description: This project aims at developing robust tracking algorithms for dealing with complex motion and shape dynamics. Current methods achieve good tracking performance in the presence of non-cluttered background and smooth motion and deformation regimes but they typically loose track if one of these conditions fails. This project studies the use of multiple deformable models with switching/mixing algorithms as a way to enlarge the tracking capabilities. This raises several interesting questions: how to combine multiple models or switch between them? Can tracking be improved if the parameters lie on manifold contained in \mathbb{R}^n ? What methods can be used to estimate the manifold and the parameter trajectory? Other topics that will be addressed in this project are multi-model learning and robust trajectory estimation methods to reduce the influence of outliers. The proposed algorithms will be tested in selected applications.

Research Areas: Image Processing

Laboratories: Signal Processing Lab.

External Partners: IST, ISEL

Initiated: 1999

Expected conclusion: 2003

Classification: PRAXIS/P/EEI/12050/1998

Documents produced in 2002:



Project name: LTT - Long Term Tracking of Multiple Objects for Surveillance

Project leader: Prof. Jorge S. Marques

Project description: This project aims to develop methods for long term tracking of multiple objects in video sequences. Multiple object tracking has received the attention of the image processing community in the last 5 years, fostered by surveillance applications and by Model Based Video Coding (MPEG).

The first works addressed short-term tracking and recognition of activities. More recent works have tried to address long term tracking of moving objects. This is a more difficult problem since it involves the ability to disambiguate the trajectories of the objects after they were grouped and occluded for some time.

This project aims to address this problem. We wish to detect moving regions in video sequences and to develop algorithms to label each region in a consistent way along the whole video sequence. An additional difficulty concerns the presence of merged regions which can not be identified by a single label. Probabilistic models, namely probabilistic networks, will be adopted to perform this task and to propagate probable labelling scenarios. The tracking algorithms will be applied in the context of urban surveillance.

Research Areas: image processing, surveillance

External Partners: Polytechnic Institute of Lisbon

Initiated: 2002

Conclusion: 2004

Classification: POSI/ CPS / 37844 / 2001

Documents produced in 2002:

Project name: HEART 3D - Measurement of the Heart Geometry from Ultrasound Images

Project Leader within ISR: Prof. Jorge Salvador Marques (IST/ISR)

Project Description: This project studies heart diagnosis tools based on 3D ultrasound techniques. The project has three main goals: i) the development of image reconstruction and heart measurement algorithms for the analysis of the cardiac cycle and computation of clinical parameters (ventricular volume, ejection fraction and wall thickness)); ii) implementation of an experimental set up for the acquisition of 3D data during medical examinations of the heart and iii) clinical evaluation of the 3D ultrasound algorithms developed in the project Bayesian reconstruction methods will be used to estimate a 3D+T model of the heart at different instants of the cardiac cycle. The region of interest will be described using a multi-scale representation based on 3D splines. The motion and deformation of the heart cavities will be obtained by segmenting the reconstructed volume at each instant of time. To fill the gaps between the inspection planes some kind of interpolation has to be devised. This operation is embodied in the Bayesian reconstruction provided that an adequate prior is used. Unfortunately popular Gaussian priors have an undesirable smoothing effect at the boundaries, which degrades the estimation of the heart walls. Therefore, a discontinuity preserving prior will be used instead. Another key aspect for achieving high quality results concerns the data model used for reconstruction.

Research Areas: medical imaging, image processing, image reconstruction, noise removal

Laboratories: Signal Processing Lab.

External Partners: Cardiology Department of Hospital de Santa Maria, University of Aveiro

Initiated: 2000

Conclusion : 2003

Classification: POSI/33726/CPS/2000

Documents produced in 2002:



Project name: AMA- Automatic Modeling of Architecture

Project leader: Prof. Pedro M. Q. Aguiar

Project description: The goal of this project is to develop a new approach to the fully automatic 3D modelling of architecture from a video sequence.

The recovery of 3D structure (3D shape and 3D motion) from a video sequence has been widely addressed in the recent past by the computer vision community. The strongest cue to estimating the 3D structure from a video clip is the 2D motion of the brightness pattern in the image plane. For this reason, the problem is generally referred to as structure from motion (SFM). Early approaches to SFM processed a single pair of consecutive frames. Two-frame based algorithms are highly sensitive to image noise. More recent research has been oriented towards the use of longer image sequences. The problem of estimating 3D structure from multiple frames has a larger number of unknowns (the 3D shape and the set of 3D positions) but it is more constrained than the two-frame SFM problem because of the rigidity of the scene. The usual approach to multi-frame SFM relies on the matching of a set of feature points along the image sequence. Dense 3D shape estimates usually require hundreds of features that are difficult to track and that lead to a complex correspondence problem. Due to this difficulty, the automatic 3D modelling from video is still an open research problem.

This project attempts to overcome the difficulty outlined above by taking into account the more distinctive characteristic of common buildings - the flatness of their walls. The methods and algorithms to be developed within this project consider particular scenes whose 3D shape is well described by a piecewise planar model. Under this scenario, instead of tracking pointwise features, one can track larger regions where the 2D motion is described by a single set of parameters. The 3D structure of the scene is then computed from the 2D motion parameters. This approach avoids the correspondence problem and is particularly suited to constructing 3D models for buildings and urban scenes that are well described by piecewise flat surfaces.

The proposed project will lead to a method that is simultaneously a powerful tool to "virtualize" buildings and urban scenes and a further step into the development of artificial vision systems. Usually, constructing 3D scene descriptions suitable to virtual manipulation requires a lot of human interaction. The usefulness of the proposed method is due to the fact that it replaces the human interaction by a procedure that recovers 3D models from a video clip in a fully automatic way. That method can also be seen as a further step into the development of artificial vision systems because the piecewise planar assumption is valid as an approximation of the shape of the environment in more general scenarios.

The approach to be followed in this project is then summarized in the following two steps:

Step i) From the video sequence, estimate the set of parameters describing the 2D motion of the image brightness pattern. The 2D displacement between two perspective views of the points that fall into a plane is given by a homography. The first part of the project will be devoted to the development of a new method to robustly estimate homographies from pairs of images.

Step ii) Given the set of parameters describing the 2D motion, compute the 3D shape of the scene and the 3D motion of the camera. The second part of the project concerns solving this large non-linear problem by using linear subspace constraints that proved to be efficient in related problems.

Research Areas: video processing

Laboratories: Signal Processing Lab.

Initiated: 2002

Conclusion: 2005

Classification: POSI/SRI/41561/2001

Documents produced in 2002:

3.1.5 UNDERWATER ACOUSTICS

Project name: DETECTION AND FUZZY CLASSIFICATION OF **TRANSIENT** SIGNALS IN THE TIME - FREQUENCY PLANE

Project Leader: Prof. Victor Barroso (IST/ISR)

Project description: New techniques for passive detection and classification of underwater acoustic transient signals are developed and tested. The focus is on theoretical and algorithmic aspects so as to achieve an acceptable compromise between optimality and robustness to model mismatches, and computational efficiency. Several classes of transients are considered, e.g., man made, mammals' signatures, and spiky noise generated by hydrothermal vents, covering a diversity of frequency bands and physically appropriate source models (deterministic and stochastic). The methods here proposed match the temporal non-stationary of transient signals. Observation noise is assumed either Gaussian or non-Gaussian impulsive.

Data representation involves filtering and sampling the received signal, followed by a linear decomposition using the discrete wavelet transforms with compactly supported short duration filters. Assuming that a delayed signal is correctly represented by its delayed coefficients, the process described is optimized, yielding the best compromise between performance and computational complexity. This implies choosing the observation intervals, the sampling frequencies, the likelihood test rates for real-time processing, and the design of the mother wavelets. Sub optimum processors are also developed for multipath ambient, assuming random multipath attenuations and delays. The proposed approach can increase the robustness of the resulting detector, requiring much less computations than the generalized likelihood ratio test.

Translating classical detection techniques to the Time-Frequency (TF) plane does not produce better detection statistics. However, working in the TF plane provides a significant advantage: more powerful pre and post processing allow operation in lower SNR's (<-5 dB). By adjusting the TF kernel, distinct sub optimal detectors result and the best suited for each specific transient can be selected. Additional complexity, due to bidimensional correlation, is combated using a generalized distribution, representing the transient as a delta distribution. This square root the computational cost. The design of that distribution, being trivial for polynomial phase signals, is generalized to accommodate the transients considered.

The performance of the proposed techniques is evaluated based on the theoretical analysis of the algorithms developed and/or on computer experiments driven by simulated and real data.

Research Areas: Statistical Signal Processing
Laboratories: Signal Processing
External Partners: Escola Naval (Portuguese Navy School)
Initiated: 2000
Conclusion: September 2003
Classification: POSI/32708/CPS/2000
Documents produced in 2002:



Project name: Acoustic Tomography Monitoring System - **ATOMS**

Project leader within ISR: Prof. Sérgio M. Jesus

Project Coordinator: Prof. Sérgio M. Jesus

Project description: The ATOMS project aims at developing an integrated system for large-scale ocean monitoring, using acoustic tomography. In order to demonstrate the feasibility of the approach, an experimental test will be performed to characterize the upwelling filament structure off the Cape São Vicente.

Objectives

- 1- To study the feasibility of a tomographic acoustic network to monitor the entire Portuguese EEZ. That network will be composed of 4/5 acoustic emitters/receivers located in the Azores, continental Portugal and Goringe bank and/or Madeira island. The modeled network will use archived data of temperature/salinity profiles (from NODC and BODC data bases). The main characteristics of the network will be determined in order to achieve a given performance in terms of temperature and current resolution.
- 2 - To develop an integrated system for Ocean Acoustic Tomography (OAT) and perform a test at sea.
- 3 - To develop a preliminary application of the integrated system to monitor a particular area off the Portuguese EEZ. The test target will be the Cape São Vicente filament area, which is one of the most developed and recurrent filaments observed and has important implications in the biological and chemical exchanges between the coastal and offshore ocean.

Research Areas: environmental monitoring
Laboratories: SiPLAB
External Partners: CINTAL, EST (UALG), CIMA, IH
Initiated: October 2000
Expected conclusion: March 2004
Classification:
Documents produced in 2002: [80]

Project name: Source Localization with a Random Field of Sonobuoys in shallow water - **LOCAPASS**

Project leader within ISR: Prof. Sérgio M. Jesus

Project Coordinator: Prof. Sérgio M. Jesus

Project description: The LOCAPASS project aims at developing an integrated system for passive source localization using a single or a small number of acoustic sensors. The principle is based on using the environmental information as modelled by an acoustic propagation model to discriminate a perturbation introduced by an active source. Previous results have shown that: i) if the sound source has a relatively large time-bandwidth product and ii) the environment is sufficiently known and stable, it is indeed possible to obtain single sensor source localization in range and depth. Actual improvements on the receiving system to provide some horizontal aperture and provide rough bearing estimation as well.

Objectives

- 1- To study the feasibility of a single sensor source localization system.
- 2 - To develop a real system based on sonobuoys.
- 3 - To experimentally test the developed system prototype at sea.

Research Areas: underwater signal processing

Laboratories: SiPLAB

External Partners: CINTAL, IH

Initiated: July 2001

Expected conclusion: July 2003

Classification:

Documents produced in 2002: [81] , [82] , [83] , [88]



Project name: Tomografia Passiva Costeira - **TOMPACO**

Project leader within ISR: Prof. Sérgio M. Jesus

Project Coordinator: Prof. Sérgio M. Jesus

Project description : The main objective of this project is to develop a new method for underwater acoustic tomography that uses as source signal the noise emitted by ships of opportunity, received on vertical arrays distributed along the coast, with the objective of measuring the water temperature and currents of oceanographic interest.

Research Areas: ocean acoustic tomography

Laboratories: SiPLAB

External Partners: DUNE(Italy), OGS (Italy), ENEA(Italy)

Initiated: May 1999

Expected conclusion: March 2003

Classification:

Documents produced in 2002: [47] , [48] , [84] , [85] , [86] , [87]

3.1.6 COMPUTER VISION

Project name: MIRROR – Mirror Neurons for Recognition

Project leader within ISR: Prof. José Santos –Victor (IST/ISR)

Project description: The goals of MIRROR are:

- 1) to realize an artificial system that learns to communicate with humans by means of body gestures and
- 2) to study the mechanisms used by the brain to learn and represent gestures.

The biological base is the existence in primates's premotor cortex of a motor resonant system, called mirror neurons, activated both during execution of goal directed actions and during observation of similar actions performed by others. This unified representation may sub serve the learning of goal directed actions during development and the recognition of motor acts, when visually perceived. In MIRROR we investigate this ontogenetic pathway in two ways:

- 1) by realizing a system that learns to move AND to understand movements on the basis of the visually perceived motion and the associated motor commands
and
- 2) by correlated electrophysiological experiments.

Research Areas: Computer Vision

Laboratories: Vislab - Computer Vision Lab

External Partners: DIST - University of Genova (I), University of Ferrara (I), Dept. of Psychology Univ. of Umea, (SE)

Initiated: September 2001

Expected conclusion: March 2004

Classification: EU - FET - 2000-28159

Documents produced in 2002: [24], [40], [113], [115]



Project name: CAVIAR - Context Aware Vision using Image-based Active Recognition

Project leader within ISR: Prof. José Santos –Victor (IST/ISR)

Project description: The main objective is to develop the theory of context-aware visual recognition systems. We will implement the theory in a complete closed-loop vision system, and apply it to two applications (city street surveillance and customer behaviour analysis). To achieve these objectives, we will develop new feature grouping, attention and appearance-based recognition processes. This will also require development of new techniques for acquiring, representing and using visual context and situation knowledge.

Research Areas: Computer Vision

Laboratories: Vislab - Computer Vision Lab

External Partners: University of Edimburgh (UK), INRIA (F)

Initiated: October 2002

Expected conclusion: September 2005

Classification: IST-2001-37540

Documents produced in 2002:

Project name: OMNISYS - Omnidirectional Vision for Navigation and Control

Project leader within ISR: Prof. José Santos -Victor (IST/ISR)

Project description: The main objectives of this project are the study of problems related to robot perception and control using catadioptric systems. In particular visual servoing will include the use of uncalibrated images. The catadioptric systems that will be considered are central projection systems. The goals will include the development of mathematical models and coordinate systems that can simplify instances of servoing. The definition of features that can be robustly tracked with this type of images is also a goal of the project as well as the development of algorithms for servoing using partially calibrated or uncalibrated images. To reach this goal a systematic approach will be used. For that purpose a general mathematical model for perspective/catadioptric imaging formation will be established, covering the situations of vision system motion and the relative motions between the mirror and the imaging device that do not violate the central projection constraint.

Research Areas: Computer Vision, Mobile Robotics

Laboratories: VisLab – Computer Vision Lab

External Partners: ISR – Coimbra Pole

Initiated: SET. 2002

Expected conclusion: AUG. 2005

Classification:

Documents produced in 2002: [10], [38], [121], [122]



Project name: 3D MODELING FROM VIDEO

Project leader within ISR: João Paulo Salgado Arriscado Costeira

Project description: This project proposes to develop a methodology for video coding by using intermediate 3D representations. The coded video includes a representation of the scene's 3D shape and texture, producing as output a sequence of synthetic views of the scene (which could be different from the original ones). This opens new perspectives to go one step forward towards general content-based video representations. There are three main issues involved which we propose to tackle:

- 1 - Image to image matching,
- 2 - Image to model matching and
- 3 - 3D model building and generation of images from the 3D model.

The main idea is to create a feedback loop of "a priori" knowledge provided by the existent 3D scene model into the matching process, in a global way. By formalizing image to image and image to model matching as an integer programming problem which is then relaxed to a concave programming problem (see [5]), authors believe the whole process of matching and 3D reconstruction can be integrated into a single recursive framework.

Research Areas: 3D reconstruction, Video Coding, Structure from motion, Computer vision

Laboratories: Vislab - Computer Vision Lab, Signal and Image Processing Lab.

Initiated: October 2000

Expected conclusion: 2003

Classification: POSI/34121/SRI/2000

Documents produced in 2002: [41]

3.1.7 ARTIFICIAL INTELLIGENCE

Project name: MS-AGENCY: Control of Manufacturing Systems using Societies of Evolutive Agents

Project leader: Prof. Luis Custódio (IST/ISR)

Project description: In this project, the problems raised by the development, utilization and implementation of both hierarchical and heterarchical control architectures for manufacturing systems (MS) are studied and identified. The goal is to develop a hybrid control architecture where the lower levels are implemented through a heterarchical structure, using a new paradigm of distributed (knowledge) representation called "Societies of Agents". The upper levels are structured into a hierarchy where the top levels provide orders for bottom levels, as usual. In terms of equipment and layout it is assumed that the shop floor is (physical or virtually) divided into a set of manufacturing cells, each one capable of producing a predefined set of products. A single agent represents each cell, which is capable of interacting within a society of similar agents.

Research Areas: Artificial Intelligence, Multi-agent Systems, Manufacturing Systems Control

Laboratories: Intelligence Systems Lab

External Partners:

Initiated: August 2001

Expected conclusion: July 2003

Classification: FCT POSI/P/EEI/12175/1998

Documents produced in 2002: [74], [136], [137]



Project name: DARE – Development of Emotion-based Robotic Agents

Project leader: Prof. Luis Custódio (IST/ISR)

Project description: The aim of this project is the study and development of methodologies and tools necessary to implement emotional robotics agents capable of dealing with unstructured and dynamic environments. Therefore, the goal is not the optimization of some particular ability, but instead the research focus is put on general competence to learn, adapt itself and survive. In order to practically test these ideas, a small autonomous robot will be adapted and used based on technology already developed and tested.

Research Areas: Artificial Intelligence, Emotion-based Agents

Laboratories: Intelligent Systems Lab

External Partners:

Initiated: August 2001

Expected conclusion: July 2002

Classification: FCT POSI/P/EEI/12184/1998

Documents produced in 2002: [77], [78], [79], [80], [81]

3.1.8 BIOMEDICAL ENGINEERING

Project name: CORTEX: A SYSTEM FOR LEARNING AND RECOGNITION OF VISUAL OBJECTS

Project leader: Prof. Agostinho C. Rosa (IST/ISR)

Project description: This project's goal is to create a model of the object recognition system in the Visual Cortex. Once it is finished, the model is intended to either acquire new object concepts or to recognize previously encountered objects. In the latter case, the model will be able to pin point an object as being "recognized", and the neural network will behave in a way similar to what has been experimentally observed in the identification systems of primates and humans. Namely, the triggering synchronization of neurons that is associated with the sight of the same object.

Research Areas: Image Representation and Object Recognition

Laboratories: Evolutionary Systems and Biomedical Engineering Lab.

External Partners:

Initiated: JAN 2001

Expected Conclusion: JUL 2002

Classification: POSI/34606/SRI/2000

Documents produced in 2002:

3.1.9 COMUNICATIONS

Project name: SEPARATION OF DIGITAL SOURCES' MIXTURES BY CONVEX METHODS

Project leader: Prof. João Senteiro

Project description: The main objective is to design a spatial division multiple access (SDMA) receiver, which permits to blindly resolve a convolute mixture of digital sources. An existing convex geometrical framework for binary sources is to be extended in order to incorporate in the receiver the following features:

- (a) robustness to the channel order detection step. By (possibly) avoiding the estimation of the orders of the space-time channels activated by the sources, the receiver will outperform (in terms of robustness) most of the current approaches, whose performance is known to depend crucially on the accuracy of these estimates - specially for band limited channels whose impulse response exhibits smooth roll offs making the channel length ill-defined. To meet this requirement, the linear equalizers have to be characterized directly in the observation space, which poses new theoretical challenges;
- (b) ability to cope with more generic digital modulation alphabets, e.g., PAM, QAM, PSK, etc;
- (c) increased robustness with respect to the noise power, which implies the formulation of new convex (or quasi-convex) problems in the "least-squares" sense.

Research areas: Mobile Wireless Communications

Laboratories: Signal Processing Lab, Theory Group

External partners:

Initiated: October 2000

Expected conclusion: October 2003

Classification: POSI/32948/CPS/2000

Documents produced in 2002:

Project name: CHANNEL ESTIMATION FOR EQUALIZATION AND SYNCHRONIZATION IN OFDM UNDERWATER ACOUSTIC COMMUNICATION SYSTEMS

Project Leader: Prof. Victor Barroso (IST/ISR)

Project description: Digital communication using acoustic modems is the method of choice for exchanging data among distant or highly mobile equipment used in various underwater activities. However, achieving efficient communication in this environment is challenging due to severe distortions that affect the transmitted signals as they undergo multiple reflections and refractions in their propagation path. Attempts to overcome these impairments in high data rate coherent modems haven't been entirely satisfactory, thus hampering their widespread adoption.

Recently, much attention has been devoted to the use of OFDM (Orthogonal Frequency Division Multiplexing) modulation for wireless and cable applications as a way of approaching channel capacity with simple transmitter/receiver architectures. In OFDM the message stream is divided into many parallel lower rate streams that modulate a set of partially overlapping orthogonal carriers. Since longer symbols are less sensitive to multipath, equalization requirements may be considerably relaxed on each sub carrier. This feature is quite appealing in underwater communications, where highly complex filters used for equalization constitute the main computational bottleneck.

Although preliminary studies on the use of OFDM for underwater coherent communication have been published, the analyses are rather superficial and should mainly be regarded as proof of concept. The present proposal will address issues that are particularly relevant in an underwater environment:

1- Channel identification and equalization are extremely important in underwater communication because multipath propagation may induce channel responses lasting hundreds of milliseconds. Unlike terrestrial OFDM applications, frequency-selective channels have to be explicitly considered. Recently developed blind or semi-blind identification techniques should be applicable under such conditions, thus reducing the need for pilot tones.

2- Significant Doppler shift may be induced in acoustic waveforms even by relatively slow emitter/transmitter motion caused by waves and currents. Performance studies for terrestrial OFDM have shown that accurate tracking of average Doppler is required to ensure low intercarrier interference. Average and differential Doppler compensation has not been studied in detail for single-carrier communications, but it will likely play an important role in underwater OFDM systems. An approach based on simple ray propagation models will be used to predict the evolution of Doppler in each path and guide the tracking algorithms.

Research Areas: Statistical Signal Processing

Laboratories: Signal Processing

External Partners:

Initiated: 2000

Conclusion: September 2003

Classification: POSI/33205/CPS/2000

Documents produced in 2002:



Project name: MODEM PARA COMUNICAÇÃO DE DADOS VIA CANAL ACÚSTICO SUBMARINO

Project Leader: Prof. Victor Barroso (IST/ISR)

Project description: Desenvolvimento de um protótipo de um modem para comunicações acústicas submarinas. Além do projecto de equipamento ao nível de hardware (electrónica, encapsulamento e integração de transdutores acústicos), existe também uma forte componente de software que visa a implementação e teste de algoritmos de processamento de sinal que permitam compensar as fortes distorções que afectam a propagação de sinais acústicos em

ambiente submarino.

Research Areas: Digital Signal Processing, Communications

Laboratories: Signal Processing

External Partners:

Initiated: May 2001

Conclusion: April 2003

Classification: Ministério da Defesa – Fundação das Universidades Portuguesas

Documents produced in 2002:



Project name: **GEODIF - DIFFERENTIAL GEOMETRY BASED SIGNAL PROCESSING TECHNIQUES FOR THE RESOLUTION OF CONVOLUTIVE MIXTURES IN WIRELESS COMMUNICATIONS SYSTEMS**

Project Leader: Prof. Victor Barroso (IST/ISR)

Project description: The spatial division multiple access (SDMA) concept for mobile radio cellular systems has recently attracted much attention. SDMA is a spectral bandwidth – saving multiple access technique which provides increased cellular capacity via effective exploitation of the spatial dimension of the radio resource. In SDMA – based wireless networks, several users within the same cell share the same time – frequency channel, as opposed to the other popular multiple access methodologies, e.g., time division multiple access (TDMA) or frequency division multiple access (FDMA), where each channel is occupied at most by one user at a time. This efficient spectral allocation strategy per cell permits to expand the overall capacity of current cellular infrastructures, without consuming additional radio frequency (RF) bandwidth. From the receiver viewpoint, the SDMA technique raises a new signal processing problem: in addition to suppression of the intersymbol interference (ISI) induced by multipath propagation, the SDMA receiver has to separate the linearly superimposed users. Current research on SDMA architectures focus on developing algorithms capable of resolving linear convolutive mixtures of digital sources. The main goal of this proposal is the optimal design of SDMA receivers based on differential-geometric tools. Here, optimality results from the full exploitation of the data model, with possible incorporation of prior knowledge (Bayesian processing).

In fact, spatial and/or temporal over sampling is the preferred data acquisition scheme in SDMA receivers, and leads to highly structured baseband data matrices. In general, these can be written as the product of a block Hankel channel matrix and a block Toeplitz signal matrix, embedded in (usually Gaussian) additive noise. Also, the entries of the signal matrix are restricted to a finite alphabet, dictated by the chosen linear digital modulation format. In the majority of current approaches, this information is only partially exploited so that they are sub optimal in that respect. Moreover, by exploiting 2nd order statistic, further structure can be incorporated into the problem, as the channel matrix can be turned unitary. In this proposal, we aim at designing maximum-likelihood (ML) estimators of the mixing channel matrix and/or of the emitted data sequences, which respect all the known algebraic restrictions. By fully matching the estimators to the data model constraints, a significant improvement of their performance can be expected. The constrained ML estimators are to be derived in a differential geometry framework. This viewpoint has recently proven to be successful in solving some other relevant signal processing problems, e.g., direction-of-arrival (DOA) estimation, denoising of corrupted Hankel matrices, and adaptive subspace tracking. For the structured ML estimation problem at hand, manifold theory seems to be the most natural setting, as the algebraic restrictions on the parameters can be efficiently expressed as Cartesian products of certain differentiable manifolds (Lie groups orthogonal matrices, linear varieties of Hankel matrices, etc.). Optimization of the constrained likelihood function is to be achieved by developing techniques of optimization over differentiable manifolds. This implies a detailed characterization of the constraint differentiable surfaces (tangent spaces, curvature, etc.), which also provides the appropriate tools to study the convergence properties of the class of algorithms to be derived.

Research Areas: Statistical Signal Processing, Communications
Laboratories: Signal Processing
External Partners:
Initiated: January 2002
Conclusion: December 2004
Classification: POSI/38775/CPS/2001
Documents produced in 2002:

3.1.10 AERONAUTICS

Project name: VELA – Very Efficient Large Aircraft

Project leader within ISR: Prof. Luis Braga Campos

Project leader: EADS - Germany

Project description: : Role of IST: Assessments of the stability of flying wing aircraft .

Research Areas: Aircraft design, airplane
Laboratories: Aeronautics Group
External Partners: 20 partners
Initiated: 2002
Expected conclusion: 2004
Classification: EU – Industrial Research
Documents produced in 2002:



Project name: ROSAS – Research on Silent Aircraft Concepts

Project leader within ISR: Prof. Luis Braga Campos

Project leader: EADS - Germany

Project description: Role of IST: Modelling of the effect of the wing in shielding the noise from the engines.

Research Areas: Acoustics, Engine noise, Diffractions
Laboratories: Aeronautics Group
External Partners: 18 partners
Initiated: 2002
Expected conclusion: 2004
Classification: EU – Industrial Research
Documents produced in 2002:

Project name: **SILENCER** – Significantly Lower Community Exposure to Noise (Reduction)

Project leader within ISR: Prof. Luis Braga Campos

Project leader: SNECMA

Project description: Role of IST: Optimization of non-uniform circumferential and longitudinal impedance distribution in engine ducts.

Research Areas: Acoustics, Engine noise

Laboratories: Aeronautics Group

External Partners: 90 partners

Initiated: 2002

Expected conclusion: 2005

Classification: EU – Industrial Research

Documents produced in 2002:



Project name: **ENABLE** – Environmental Noise Associated with Turbulent Boundary layer Excitation

Project leader within ISR: Prof. Luis Braga Campos

Project leader: Dassault

Project description: Role of IST: Prediction of sound generation by turbulence in a boundary layer and of the correlation of the acoustic pressure induced on the fuselage of an aircraft.

Research Areas: Aeroacoustics, Aircraft design

Laboratories: Aeronautics Group

External Partners: 16 partners

Initiated: 2001

Expected conclusion: 2003

Classification: EU – Industrial Research

Documents produced in 2002:



Project name: **JEAN** – Jet Exhanot Aerodynamics & Noise

Project leader within ISR: Prof. Luis Braga Campos

Project leader: Trinity College Dublin

Project description: Role of IST: Research on the relation between the spectrum of turbulence and the spectrum of noise it radiates and on the transmission of sound in a shear layer

Research Areas: Acoustics, Aerodynamics, turbulence

Laboratories: Aeronautics Group

External Partners: 10 partners

Initiated: 2001

Expected conclusion: 2005
Classification: EU – Industrial Research
Documents produced in 2002:



Project name: **S-WAKE** – Assessment of Wave vortex safety

Project leader: Prof. Luis Braga Campos

Project description: Industrial Research Project, funded by European Union, under 5th Framework Programme, 1st call, Promoting Competitive and Sustainable Growth/Key Action Aeronautics; leader – NLR; partner: see table F-0; role of IST – establishment of analytical formulas to predict safe separation distance between aircraft, based on aerodynamic, control and flight parameters and atmospheric conditions, and comparison with computer models, piloted simulations and flight tests.

Research Areas: Flight Dynamics, aircraft management , Airplane response

Laboratories: Aeronautics Group

External Partners: 18 partners

Initiated: 2000

Expected conclusion: 2002

Classification: EU – Industrial Research

Documents produced in 2002:



Project name: **X-Noise** – Aircraft External Noise Network

Project leader: Prof. Luis Braga Campos

Project description: Research on all aspects of Aircraft external noise.

Research Areas: Aeroacoustics, Aircraft Noise

Laboratories: Aeronautics Group

External Partners: 30 partners

Initiated: 2002

Expected conclusion: 2004

Classification: EU – Industrial Research

Documents produced in 2002:



Project name: **NEFA** – New Empenage for Aircraft

Project leader within ISR: Prof. Luis Braga Campos

Project leader: Airbus France

Project description: role of IST: assessment of coupling of longitudinal and lateral stability.

Research Areas: Aeroacoustics, Aircraft Noise

Laboratories: Aeronautics Group

External Partners: 30 partners

Initiated: 2002

Expected conclusion: 2004

Classification: EU – 5th Framework Programme

Documents produced in 2002:

3.1.11 UNMANNED AIR VEHICLES

Project name: ALTICOPTER

Project leader within ISR: Prof. Carlos Silvestre (ISR / IST)

Project Coordinator: Prof. Carlos Silvestre (ISR / IST)

Project description: Today, some Unmanned Air Vehicles (UAVs) exhibit a high degree of reliability in operation in the presence of dynamic and uncertain environments and challenging operating scenarios. Among the many UAV configurations available today, helicopters are one of the most maneuverable and versatile platforms. They can takeoff and land without a runway and can hover in place. These capabilities have brought about the use of unmanned helicopters as highly maneuverable sensing platforms, allowing for the access to remote and confined locations without placing human lives at risk. For these reasons, there is currently great interest in using unmanned robotic helicopters in a wide range of applications that include crop spraying, hazardous spill inspection, fire surveillance, pollution monitoring, overhead power cables inspection, bridge and building construction inspection, etc.

The major stumbling blocks that have prevented UAVs from executing successfully the aforementioned missions are: i) the unavailability of reliable on-board navigation systems capable of integrating the information from sophisticated sensor suites; ii) the absence of efficient and easy to program mission control systems; iii) the lack of simple and effective controllers for precise 3-D trajectory tracking and path following.

The main thrust of the project is the development of an unmanned robotic helicopter that can serve as an advanced platform for system design, development, and testing. The project will use an industrial radio controlled helicopter that will be equipped with a distributed real time computing network, a reliable wireless communication system, and sensing devices. To give the work greater focus, the research and development effort will be aimed at performing realistic missions that consist of accurate monitoring of beaches and dunes using airborne laser altimetry. The nature of the envisioned missions will require the use of a 3-D perception system onboard the helicopter. This system will include a highly accurate GPS, a Laser Range Finder, and a Digital Camera. The resulting platform will have the potential for being used in a variety of applications, and will provide subject matter for further research and development.

Underlying the development of unmanned helicopters are their on-board real time navigation, flight control, and mission control systems. These systems will stabilize the platform and implement the different vehicle operation modes. Research will also focus on the development of sensor based control strategies for critical flight conditions, such as automatic landing. Furthermore, to improve the accuracy of the airborne laser altimetry, special emphasis will be placed on developing 3-D path following and trajectory tracking controllers.

Research Areas: Nonlinear dynamic modeling, Guidance and Control, Inertial Navigation, laser and vision mapping.

Laboratories: DSOR, VISLAB

External Partners: Instituto Geológico e Mineiro, Lisbon, Portugal

Initiated: May 1 2002

Expected conclusion: April 30 2005

Classification: POSI/41938/CPS/2001

Documents produced in 2002: [144] , [153] , [156] .

3.1.12 NON-LINEAR CONTROL

Project name: High Resolution Optical Satellite Sensors

Project leader within ISR: Prof. Pedro Lima (ISR / IST)

Project Coordinator: Alenia Spazio (Italy)

Project description: The main objective of this project is to develop a High Resolution Optical Satellite Sensor by using the synthetic aperture technique. This technique consists in the reconstruction of the original image of an object starting from that formed on the common focal plane of a set of telescopes (or a multi-aperture telescope) observing simultaneously the object while maintaining constant within a fraction of wavelengths the phase of the various wavefronts which are combined together (namely, a set of telescopes correctly co-phased, which, in this case, operate like an interferometer). The synthetic aperture technique thus allow to obtain the same resolution of a monolithic-mirror by means of a set of smaller mirrors properly arranged over the surface covered by the monolithic one, with a dramatic reduction of the volume and the mass of the optics. ISR participation will cover the control of the mirror positions.

Research Areas: Satellites Formations, Non-linear control

Laboratories: Intelligent Systems Lab

External Partners: INETI (Portugal), CSL (Belgium)

Initiated: November 2002

Expected Conclusion: May 2005

Classification: EUCLID - RTP 9.09

Documents produced in 2002:

3.2 POST-DOCS ACTIVITIES REPORTS

3.2.1 Activity report of DIDIK SOETANTO

My main topic of research is nonlinear system theory with applications to the control of robotic vehicles. The final goal of my research program is to derive algorithms for trajectory tracking and path following control of surface and underwater vehicles, as well as for coordinated motion control of multiple robots. Given the scope and difficulty of the problem at hand, the initial research work was focused on the development of nonlinear trajectory tracking and path following controllers for underactuated wheeled robots. This choice was dictated by the fact that marine robots exhibit complex hydrodynamic terms that tend to clutter control system design. Thus, at a first stage, it is entirely appropriate to grasp the essence of the problems of trajectory tracking and path following by resorting to the simpler dynamic models that arise in ground robotics. The extension of the methods developed to tackle the far more complicated case of marine robots can then be done on a more solid basis. In what follows I summarize the key results obtained so far. Some of the work was done in cooperation with Dr. Lionel Lapierre of the DSORL.

1. PATH FOLLOWING CONTROL OF NONHOLONOMIC DYNAMIC WHEELED ROBOTS with PARAMETRIC MODELING UNCERTAINTIES

Objective:

The practical problem that motivated this research topic is that of driving an underactuated robot along a desired 2-D path. The vehicle model is subjected to parameter uncertainties.

Results:

A new methodology was derived for path following control of underactuated ground robots subjected to parametric modeling uncertainty. Previous results obtained by Samson and coworkers on path following control for kinematic models of wheeled robots were extended in order to deal explicitly with *vehicle dynamics* and *parameter uncertainty*. A nonlinear, adaptive control law was derived that yields convergence of the closed loop system error trajectories about a path to zero. Controller design relies on Lyapunov theory and backstepping techniques. A formal proof of error convergence was found. Simulations were run to illustrate the performance of the control system proposed.

Documents:

D. Soetanto, L. Lapierre, and A. Pascoal. "Path Following Control of a Nonholonomic Dynamic Wheeled Robot with Parametric Modeling Uncertainties," DSORL-ISR Technical Report, September 2002.

Status: Pending submission to a journal and to the European Control Conference (ECC 2003).

2. ADAPTIVE, NON-SINGULAR PATH-FOLLOWING CONTROL OF DYNAMIC WHEELED ROBOTS

Objective:

To derive path following control algorithms for wheeled robots that avoid stringent initial condition constraints described in the literature.

Results:

This work addressed the problem of steering the dynamic model of a wheeled robot of unicycle type along a desired path. Its main contribution is twofold: i) it extends the results obtained in (Micaelli and Samson, 1993) - for kinematic models of wheeled robots - to a more general setting, in order to deal with vehicle dynamics and parameter uncertainty, and ii) it overcomes stringent initial condition constraints that are present in a number of path following

control strategies described in the literature. This is done by controlling explicitly the rate of progression of a "virtual target" to be tracked along the path, thus bypassing the problems that arise when the position of the virtual target is simply defined by the projection of the actual vehicle on that path. This procedure avoids the singularities that occur when the distance to path is not well defined and allows for global convergence of the actual path of the vehicle to the desired path. This is in striking contrast with the results described in (Micaelli and Samson, 1993) for example, where only local convergence has been proven. To the best of my knowledge, the idea of exploring the extra degree of freedom that comes from controlling the motion of a virtual target along a path appeared for the first time in (Aicardi et al., 1995) for the control of wheeled robots. This idea was later extended to the control of marine craft in (Aicardi et al., 2002). However, none of these references addresses the issues of vehicle dynamics and parameter uncertainty. Furthermore, the methodologies adopted in (Aicardi et al., 1995, Aicardi et al., 2002) for control system design build on an entirely different technique that requires the introduction of a nonsingular transformation in the original error space. In this work, controller design builds on the work reported in (Micaelli and Samson, 1993) on path following control and relies heavily on Lyapunov based backstepping techniques in order to extend kinematic control laws to a dynamic setting. Parameter uncertainties are dealt with in an adaptive framework by augmenting Lyapunov candidate functions with terms that are quadratic in the parameter errors. See (Aguiar et al., 2000) where identical techniques were used in the design of an adaptive control law to steer the dynamic model of a wheeled robot to a point, with a desired orientation, in the presence of parameter uncertainty.

Documents:

L. Lapierre, D. Soetanto, and A. Pascoal, "Adaptive, Nonsingular Path Following Control of Dynamic Wheeled Robots," DSORL-ISR Technical Report, July 2002.

Status: Pending submission to a journal and to the ICAR Conference, Coimbra, Portugal.

References

Aguiar, A.P., Atassi, A., and Pascoal, A.M., "Regulation of a Nonholonomic Dynamic Wheeled Mobile Robot with Parametric Modeling Uncertainty Using Lyapunov Function," *Proc. 39th IEEE Conference on Decision and Control*, Sidney, Australia, December 2000.

Aicardi, M., Casalino, G., Bicchi, A., and Balestrino, A., "Closed Loop Steering of Unicycle-Like Vehicles via Lyapunov Techniques," *IEEE Robotics and Automation Magazine*, pp. 27--35, March 1995.

Aicardi, M., Casalino, G., Indiveri, G., Aguiar, P., Encarnação, P., and Pascoal, A., "A Planar Path Following Controller for Underactuated Marine Vehicles," *Proceedings of MED2001*, Dubrovnik, Croatia, June 2001.

Micaelli, A. and Samson, C., "Trajectory-Tracking for Unicycle - Type and Two - Steering - Wheels Mobile Robots," *Technical Report No. 2097*, INRIA, Sophia-Antipolis, Nov. 1993.

3. NONLINEAR PATH FOLLOWING CONTROL OF AUTONOMOUS UNDERWATER VEHICLES

Objective:

To derive path following control algorithms for autonomous underwater robots.

Results:

This work was inspired by previous results on path following described in (Encarnação, 2001) that deal with the control of marine vehicles in three dimensional space and address explicitly the presence of non-negligible marine vehicle dynamics. The methodology for path following proposed in (Encarnação, 2002) can be easily understood by recalling that the total velocity vector of an AUV is not necessarily aligned with the vehicle's main axis, as in the case of wheeled robots (AUVs do sideslip). However, by drawing a simple analogy between the problems of path following for wheeled robots and AUVs, the latter can be cast as the equivalent problem of aligning the total AUV velocity vector with the tangent to the path by manipulating the vehicle's yaw rate. It is important to remark that in spite of its broader scope of applications, the results in (Encarnação, 2002) inherit the major shortcoming already

present in path following control strategies for wheeled robots described described in the literature: *the initial distance of the vehicle to the path must be smaller than the smallest radius of curvature that is present in that path*. The work reported here lifts this restriction entirely. This is done by controlling explicitly the rate of progression of a "virtual target" to be tracked along the path, thus bypassing the problems that arise when the position of the virtual target is simply defined by the projection of the actual vehicle on that path. *This technique was first proposed under item 2 above for wheeled robots in my work referred before*. This design procedure effectively creates an extra degree of freedom that can then be explored to avoid the singularities that occur when the distance to path is not well defined (this occurs for example when the vehicle is located exactly at the center of curvature of a circular path). Controller design starts at a kinematic level and evolves to a dynamic setting using backstepping techniques. The resulting control strategy yields global convergence of the actual path of the vehicle to the desired path.

Documents:

L. Lapierre, D. Soetanto, A. Pascoal, "Nonlinear Path Following Control of Autonomous Underwater Vehicles," DSORL-ISR Technical Report, October 2002.

Status: Pending submission to a journal and to the IFAC Workshop on Guidance and Control of Underwater Vehicles, Newport, UK, 2003.

References

Pedro Encarnação, "Nonlinear Path Following Control Systems for Ocean Vehicles," PhD Thesis, Instituto Superior Técnico, April 2002, Portugal.

Lisboa, January 2003
Didik Soetanto, Ph.D.
Instituto de Sistemas e Robótica
Instituto Superior Técnico

3.2.2 Activity report of LIONEL LAPIERRE

My research work at the DSORL is funded by the HPRN European FREESUB Network, coordinated by the French company Cybernetix. The "FREESUB" network addresses the exchange of human resources that are essential to the development of autonomous unmanned sub-sea vehicles (AUVs) for remote intervention on fixed underwater structures. Among the topics under study at the DSORL in the scope of this network, the following are worth pointing out:

- i) development of *global and local navigation algorithms* to obtain accurate estimates of the position, attitude (and respective rates) of a marine vehicle by fusing multi-rate, possibly asynchronous, sensor data with different latencies in the measurements.
- ii) study of algorithms to achieve good trajectory tracking or path following of a marine robot or groups of marine robots in the presence of hydrodynamic parameter uncertainty and unknown external disturbances (e.g. wind, currents, and waves in the case of an autonomous surface craft).

During the year of 2002, with a view towards meeting the above objectives, my main topics of research were *sensor-based nonlinear control theory with applications to the control of marine robots*. Some of the work was first done for wheeled robots, in order to capture the essence of the problems to be solved in a much simpler setting. The extension of the methods developed to tackle the far more complicated case of marine robots can then be done on a more solid basis. In what follows I summarize the key results obtained so far. Some of the work was done in cooperation with Dr. Didik Soetanto of the DSORL.

1. UNICYCLE VISION BASED PATH FOLLOWING CONTROL

Objective :

The main goal of this work was to develop a strategy to drive a non-holonomic wheeled robot of the unicycle-type along a 2-D desired path that is visible in the image plane, while avoiding the singularities that may arise when the vehicle's distance to the path is not well-defined.

Results :

The methodology adopted for path following control deals explicitly with vehicle dynamics. Furthermore, by introducing the concept of a 'virtual target' to be tracked along the path, potential singularities in the control law are avoided. The feedback control law derived explores the interaction between features in the cartesian space and in the image plane and includes measurements provided by other robot sensors. Simulations were used to illustrate the performance of the control system proposed.

Documents:

L. Lapierre, D. Soetanto and A. Pascoal. "Unicycle Vision Based Path Following Control" DSORL-ISR Technical Report, September 2002.

Status: Pending submission to a journal and to the IEEE Mediterranean Conference (MED 2003), Rhodes, Greece.

2. NON LINEAR PATH FOLLOWING CONTROL OF AUTONOMOUS UNDERWATER VEHICLES

Objective :

To derive path following control algorithms for autonomous underwater robots in 2-D.

Results (see also the report of Didik Soetanto) :

They key contribution of this work was the development of a new path following control law for autonomous underwater vehicles that takes explicitly into account the vehicle dynamics and avoids singularities that are present in a number of path following algorithms described in the literature. Controller design builds on Lyapunov theory and backstepping techniques. The resulting non linear feedback control law yields convergence of the path following error trajectories to zero. Simulations were used to illustrate the performance of the proposed solution.

Documents:

L. Lapierre, D. Soetanto, A. Pascoal, "Nonlinear Path Following Control of Autonomous Underwater Vehicles," DSORL-ISR Technical Report, October 2002.

Status: Pending submission to a journal and to the IFAC Workshop on Guidance and Control of Underwater Vehicles, Newport, UK, 2003.

3. COORDINATED MOTION CONTROL OF MARINE ROBOTS

Objective :

To study the problem of coordinated motion control of multiple marine vehicles.

Results:

Recently, there has been much interest in the problem of coordinated motion control of fleets of autonomous vehicles. Examples include formation flying control, spacecraft formation control, coordinated control of wheeled mobile robots, and control of multiple marine craft, including surface and underwater vehicles. The work reported in the literature addresses a large class of practical problems that include, among others, leader following and control of the center and radius of dispersion of a swarm of vehicles. This work addresses the special problem of coordinated motion control of marine craft that arises when both vehicles are required to follow two identical paths where one is a spatially shifted version of the other. The rationale for this problem can be best understood by referring to a number of practical mission scenarios:

1. **Combined autonomous surface craft / autonomous underwater vehicle control** (Encarnação, 2002). In this scenario, an autonomous surface craft (ASC) is required to follow a desired path accurately while an autonomous underwater vehicle (AUV) operating at a fixed depth is required to follow exactly the same horizontal path (shifted in the vertical coordinate), while tracking the ASC motion along that path. In this example the AUV serves as a mobile sensor suite to acquire scientific data, while the ASC plays the role of a fast communication relay between the AUV and a support ship. Thus, the ASC effectively explores the fact that high data rate underwater communications can best be achieved if the emitter and the receiver are aligned along the same vertical line. Notice how both vehicles are required to follow exactly the same type of path, which is imposed by the scientific missions at hand.
2. **Combined autonomous underwater vehicle control: video acquisition.** This scenario occurs when an underwater vehicle carries a strong light source and illuminates the scenery around a second underwater vehicle that must follow a pre-determined path and acquire video images for scientific purposes.
3. **Combined autonomous underwater vehicle control: fast acoustic coverage of the seabed.** In this important case, two vehicles are required to fly above the seabed at the same or different depths, along parallel paths, and map the seabed using two copies of the same suite of acoustic sensors (e.g. sidescan, mechanically scanned pencil beam, and subbottom profiler). By requesting the two vehicles to traverse identical paths so as to make the acoustic beam coverage overlap on the seabed, large areas can be covered in a fast manner.

In all cases, one of the vehicles (leader) follows a path and the second vehicle (follower) is required to track the first one. A cursory analysis of the problem seems to indicate that a solution is at hand once a path following and a trajectory controller have been found for the leader and the follower vehicle, respectively. However, the problem is far more complex than a simple analysis suggests. Consider the first mission scenario, where the (leader) surface vehicle may deviate from its planned path due to wind, currents and wave action. In this case, scientific mission requirements dictate that the underwater vehicle (that is much less susceptible to external disturbances) remain on the nominal path adopted, and that while on that path it should maneuver to stay in the vicinity of the leader in order to not lose the fast vertical communications link. The solution adopted in (Encarnação, 2002) consisted of forcing the

follower to "track the projection of the leader onto the 2-D nominal path". However, the control law adopted there for coordinated vehicle control has two major drawbacks: i) it requires the computation of trajectory tracking controllers for both vehicles, and ii) the large amount of information to be exchanged between the two vehicles makes it hard to apply in practice, due to the absence of a high data rate underwater acoustic link.

In this work, with the view to obviate the problems referred to above, a completely new approach is taken to the problem of coordinated vehicle control. A nonlinear control law is derived to steer two underwater vehicles along parallel paths, while ensuring that the lateral distance between them remains constant. The work builds on recent results obtained by the authors on path following control that allow dealing explicitly with vehicle dynamics and overcoming stringent initial condition constraints that are present in a number of path following control laws described in the literature. Motivated by the work described before on *nonlinear path following control of autonomous underwater vehicles*, this is done by controlling explicitly the rate of progression of a "virtual target" to be tracked along the path, thus bypassing the problems that arise when the position of the virtual target is simply defined by the projection of the actual vehicle on that path. The key idea explored in the present work is to elect one of the vehicles as leader and the other as follower. Both the leader and follower execute the same path following algorithm, the leader travelling along the path at a desired speed profile. The velocity of the follower is then adapted based on a measure of the "generalized distance" between the two vehicles along the paths. Thus, only a low data rate communication channel is required between the two vehicles. Controller design builds on Lyapunov theory and backstepping techniques. The resulting nonlinear feedback control law yields convergence of the two vehicles to the respective paths and forces the follower to accurately track the leader asymptotically.

Documents:

[H1] Lapiere, D. Soetanto, and A. Pascoal, "Coordinated Motion Control of Marine Robots," DSORL-ISR Technical Report, December 2002.

Status: Pending submission to a journal and to the IFAC MCMC'2003 Conference, Girona, Spain.

References

Pedro Encarnação, "Nonlinear Path Following Control Systems for Ocean Vehicles," PhD Thesis, Instituto Superior Técnico, April 2002, Portugal.

4. RECENT WORK (reports not available yet)

Main topics:

- i) Non linear bottom following control of AUVs.
- ii) Combined Path Following/Trajectory tracking algorithm for marine vehicles.
- iii) Extension of the vision based control described in item 1 (Unicycle Vision Based Path Follow Control) to underwater vehicles

Lisboa, January 2003
Lionel Lapiere, Ph.D.
Instituto de Sistemas e Robótica
Instituto Superior Técnico

3.2.3 Activity report of SERGEY RUMYANTZEV

(Period of reporting: January-March 2002)

During the final phase of my post-doc activity at ISR, my research work was focused on the two topics described below:

1. A LOOP SHAPING APPROACH BASED ON APPROXIMANTS TO H-INFINITY SOLUTIONS WITH APPLICATIONS TO THE DESIGN OF SHIP COURSE KEEPING PID CONTROLLERS

The work led to a new methodology for the design of ship course keeping controllers. The methodology builds on H_∞ control techniques and aims at the implementation of course keeping controllers so as to meet desired performance specifications. The desired system's performance is expressed in terms of selected output and control weighting functions. The corresponding H_∞ -optimal controller is approximated by a PID structure followed by a low pass filter. The controller is parameterized by a single parameter, which allows for efficient shifting of the Bode plot of the open-loop transfer function. It is shown that the PID controller parameters can be directly found in terms of selected output and control weighting functions without explicitly solving the underlying H_∞ problem. Furthermore, numerical indices describing the system's performance at low and high frequencies are introduced. The notion of a Pareto set of these indices is introduced, and an efficient algorithm to find the Pareto set is proposed. A diagram is given that describes the achievable system's performance at low, medium, and high frequency regions.

Documents:

[H18] S. Rumyantsev, A. Miroshnikov, A. Pascoal, E. Popova, "A Loop Shaping Approach Based on Approximations to H_∞ -solutions with Applications to Design of Ship Course Keeping PID Controllers," DSORL-ISR Technical Report, March 2002.

Status: Pending submission to a journal.

2. ACCELERATION FEEDBACK FOR THE CONTROL OF MARINE CRAFT .

Marine vehicles are often required to operated in the presence of strong wave action. Under these conditions, the vehicles must be capable of combating wave disturbances to ensure that adequate course and / or attitude control are met, as defined by vehicle mission requirements. In the case of conventional surface vehicles, these objectives call for the design and implementation of course keeping controllers to guarantee robustness against plant parameter uncertainty and adequate heading command tracking, while ensuring good wave disturbance attenuation over a desired bandwidth. In the case of hydrofoil craft, these control requirements must be enlarged to include good depth command following for comfortable sea wave riding. Finally, in the case of AUVs that are required to maneuver close to the surface, feedback control systems must be designed to stabilize the vehicle, guarantee sufficiently rapid responses to depth commands, and minimize drag induced by the corrective actions of bow and stern planes in their attempt to reduced the effect of wave disturbances on pitch and heave motions.

Work on wave disturbance rejection for ocean vehicles has been addressed in the literature by resorting to advanced control theory, coupled with wave disturbance estimation. However, many of the controllers design methods tend themselves to control structures that are complex, thus making the task of applying them to real life problems hard at best. In this work, a conceptually simple method is developed to satisfy two often conflicting requirements: stability/ command following and disturbance reduction. This is done by using acceleration feedback explicitly. Interestingly enough, the methodology developed allows for the implementation a feedback loop that counteracts the disturbance *without changing the non-disturbed plant dynamics*. Thus, it leads naturally to a *separation principle whereby command tracking and disturbance rejection loops can be designed independently*. Control system design is done in two steps: i) a state feedback or output feedback controller is designed for good command following, noise attenuation, robustness against parameter variation and desired eigenvalue placement, and ii) the controller is then simply

transformed by adding an extra acceleration feedback loop that can be properly designed to reduce the effect of wave disturbances on control system's performance. The overall control system (state/output feedback plus disturbance feedback) leaves the properties obtained in step i) unchanged.

Documents:

[H19] S. Rummyantsev, A. Pascoal, C. Silvestre, "Acceleration Feedback for the Control of Marine Craft," DSORL-ISR Technical Report, April 2002.

Status: Pending submission to the IFAC MCMC'2003 Conference, Girona, Spain.

Lisboa, March 2002
Sergey Rummyantsev, Ph.D.
Instituto de Sistemas e Robótica
Instituto Superior Técnico

3.2.4 Activity report of OGNYAN MANOLOV

Subject of work: Co-operative Mobile Robots Control in Unstructured Environments
Visiting Investigator: Assoc. Prof., Dr.-Eng. Ognyan B. MANOLOV, ICSR-BAS, Bulgaria
Period: March – September 2002

Control of mobile robots moving in unknown environments requires a method of identifying the positions and orientations of the robots. There are two main problems, which disturb the execution of path following task. The first problem concern the vehicle's kinematics motion model since errors in the kinematics model result in systematic biases in the odometry motion estimate. The second problem is non-holonomic dynamics of the vehicle motion due to slip. The amount of slip is dependent on the speed and steering angle of the vehicle and is particularly an issue with outdoor vehicles where different surfaces will produce varying degrees of slip. Co-operative autonomous systems are a well-established field of robotics but not so often the idea of a co-operation with the special purpose of pose estimation has been explicitly addressed. Therefore the target for investigations was directed to cooperative localization and navigation of mobile robots.

A simple and reliable co-operative positioning technique for the estimation of the relative position and heading of mobile robots – a group consisting of two robots, in environment, whose map is partially or totally unknown a priori, are developed. The proposed cooperative schemes are based on the optical and/or ultrasonic identification of portable landmarks-beacon that allow calculating both the positions and orientations of the robots, [1].

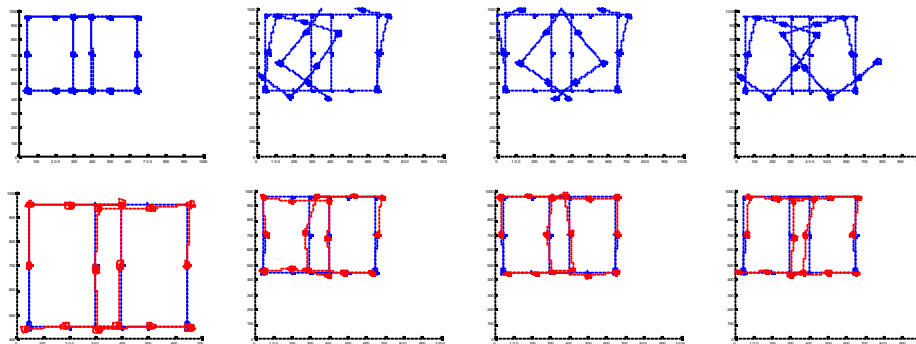

Relative cooperation positioning for 2 robots.

Here an implementation of the co-operative positioning technique for environment exploration by mobile robot cooperation is presented. Due to physical properties of the light and ultrasound waves the information acquired from any fixed position is very sparse. Therefore the map must be constructed linking together the sequences of measurements acquired from different successive positions along the robot's path. It is necessary to move the range finder relative to the objects that should be mapped. Updating of the environment map is then based on the range data collected as the robot moves in short steps along the given path. At the end of each step the exploration robot performs a complete scanning of the environment.

The simulation programs are developed in MatLab 6.0 environment. The simulation scene is depicted in Fig. 36. There is a floor plan of a laboratory room (6m x 4m) with walls, door, and an (unknown) object F in the middle of the room. The exploration robot R1 as well as the reference robot R2 is near the door. The planned path of the robots is defined by a set of co-ordinates of reference points in laboratory frame of reference and is depicted by dotted line.

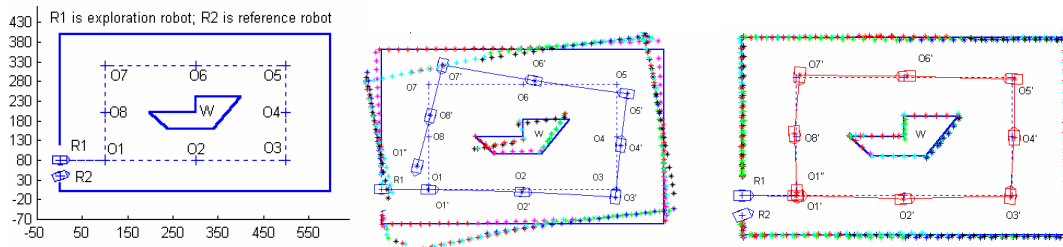

Environment exploration by 2 mobile robots cooperation.

In the further investigations the idea for cooperative localization and navigation is extended to a set of three equivalent robots moving in a plane. A simple strategy for local navigation of robots group is presented, where each robot acts at the same time as a portable landmark to the others. All robots are equipped with a radio modem, a beacon, and a camera mounted on a rotating pan-tilt unit. The described method for co-operative positioning consisting of a localization technique and an algorithm for local navigation is tested by simulation of three mobile robots, named **LR**, **WR** and **BR**, where the geometric trajectories of the robots movement are generated as a set of 'sub-goals'.

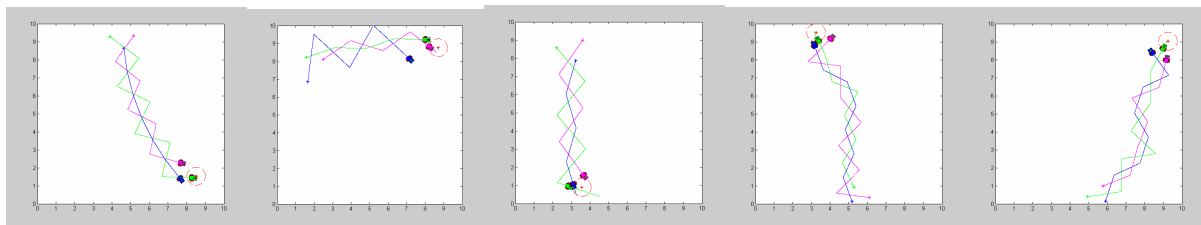

Three mobile robots cooperation with local navigation.

Computer programs are developed under MATLAB/SIMULINK, which realize the different steps of the localization techniques for groups of two and three mobile robots. Simulations and experimental results for unmapped unstructured environment exploration by group of two mobile robots are provided.

An approach of adaptive controller design for a mobile robot movement control along the trajectory is developed to cope with the parametric uncertainty associated with the dynamic model (i.e., mass, inertia, and friction coefficients) and the influence of unpredicted disturbances from the external environment, [2].

During the period of the visiting investigator's Fellowship, two presentations of the results on the international scientific meetings were realized, as following:

1. Noykov Sv., A. Lekova, O. Manolov. "Relative Location and Cooperation of Two Mobile Vehicles with WEB-based Application". Proc. of IEEE Intelligent Vehicles Symposium IV'2002, June 18-20, Versailles, France, CD ROM paper No IV32, 2002.
2. Manolov O. B. "Adaptive Steering Control For Autonomous Mobile Robots". Proc. of 10-th IEEE Mediterranean Conference on Control and Automation MED'2002, July 9-12, Lisbon, Portugal, CD ROM paper No 280, 2002.

Lisboa, September 2002
Ognyan Manolov, Ph.D.
Instituto de Sistemas e Robótica

3.2.5 Activity report of VANESSA CORRE

Subject of work: Range-dependant matched-field tomography

Period: July 2001 - July 2002

A new application of a matched-field inversion method for estimating the range and time variability of ocean properties was studied. The method uses acoustic data from a single array-source pair. Since estimating range-dependent properties with such a simple configuration is a problem which solution may not be unique, the primary objective is to obtain the variability trend rather than very accurate estimates of the properties. The inversion method was applied to a synthetic data set obtained during the simulated development of an upwelling filament. The objective consists in estimating the sound-speed profile of the filament, its position and width, and the variations of these properties with time. The performance of the method is first tested in the ideal case where no noise nor model mismatch is present. Results show the feasibility of tracking the upwelling and obtaining good accuracy for the parameter estimates within a reasonable computation time. The presence of noise in the data or model mismatch degrades the accuracy of the parameter estimates. However the global rise of cold water can still be detected and localized under realistic conditions. Although the filament properties as well as the source and array positions have noticeable effects on the inversion results, no clear evidence of a parameter hierarchy was found.

Lisboa, January 2003

Vanessa Corre, Ph.D.

SPILAB

Universidade do Algarve

3.2.6 Activity report of SANDRA GADANHO

Period: February 2002 to January 2003

Research Work

The research work developed during 2002 consisted fundamentally in the improvement of the ALEC architecture proposed during the first year of this post-doc grant and in its more exhaustive experimentation. This is architecture with two levels: an emotional one and a cognitive one. Its objective is to exploit the benefits of the interaction of these two levels in a learning task. This year we have proceeded to a deepening of the experimental results having in mind its publication in an international magazine. Details about the work developed can be found in the article "*Learning Behavior-Selection by Emotions and Cognition in a Multi-Goal Robot Task*" (<http://isr.ist.utl.pt/~sandra>).

In September, I initiated the co-supervision of the final year project entitled "Learning in the long term in an emotional agent". This project was proposed by me in the scope of the degree in Electrical and Computer Engineering course offered by IST and has as objective the integration of learning by reinforcement techniques in the GIVE architecture (emotional agents architecture developed at ISR).

Also in September, we received the visit of Dr. Javier Lorenzo Navarro that lectures in the Department of Computer Science of the University of Las Palmas. This visit followed prior contacts initiated in June. Since then Dr. Navarro had already tested in a anthropomorphic robot head an implementation of the model of emotions that I have developed during my Ph.D. work. This head was developed in the University of Las Palmas and its objective is to provide a rich social interaction with humans. The visit has enabled the discussion of ideas concerning the future of this project, namely about how to implement the ideas about emotional agents developed in the ISR and during my previous work.

Publications

- "*Emotional and Cognitive Adaptation in Real Environments*" Symposium on "*Agent Construction and Emotions*" at the EMCSR'2002 (*16th European Meeting on Cybernetics and Systems Research*), 2 - 5 de April 2002. "*Best Paper Award*".
- Submission of the paper "*Robot Learning by Emotions and Cognition*", that describes in detail the ALEC architecture developed in this post-doc program, to the WGW' 02 *EPSRC BBSRC International Workshop Biologically Inspired Robotics: The Legacy of W. Grey Walter*. This workshop due to the impressive list of highly prestige invited scientists has raised high expectations in the community. This paper was subsequently rejected.
- In October, I submitted the paper "*Learning behaviour selection in to multi goal robot task*" co-authored with Luis Custodio to a special edition of the international magazine Informatica dedicated to "*Perception and Emotions Based Reasoning*". The paper addresses the first phase of the post-doc work involving the development of an emotional system based in homeostatic variables. This system was subsequently integrated in the ALEC architecture. This paper is still under revision.
- In December, I submitted to the Journal of Machine Learning Research edited by the MIT Press, the paper "*Learning Behaviour Selection by Emotions and Cognition in to Multi Goal Robot Task*". This paper summarises the work done in the last two years, containing the more important results obtained. It presents the ALEC architecture that is the result of the post-doc work, detailing its several development stages in a coherent and motivated form. It has involved the repetition of the experiences in order to obtain more extensive and coherent results. This paper was accepted.

Seminars

- Seminar "*Learning in Real Environments by Emotions and Cognition*" at IPAB (*Institute of Perception, Action and Behaviour*) of University of Edinburgh, 23 April 2002.

Participations

- Member of the scientific committee of the Technological and Scientific Conference in Engineering carried out by ISEL 6 - 10 of April. Participation as moderator in the Artificial Intelligence session.
- Participation at the Conference "*Emotion, evolution & rationality*", an interdisciplinary conference organized by the King's College, London, 27 and 28 of April 2002. Among the invited scientists were António Damásio, Paul Griffiths, Ray Dolan and Stephen Stich.
- Participation and presentation of the poster "*Asynchronous Learning by Emotions and Cognition*" at the International Conference in Simulation of Adaptive Behaviours "*From animals to Animats 7*" (SAB'02), 4 - 9 August, Edinburgh. Gulbenkian Foundation has partially funded this participation.
- Participation in the Seminar "International interdisciplinary seminar on new robotics, evolution and embodied cognition" Gulbenkian Foundation, 12 - 15 November 2002.

Reviewer

In July, I participated in the reviewing committee of the magazine Adaptive Behaviour (MIT Press) No. 10 special edition on "Plastic Mechanisms, Multiple Timescales and Lifetime Adaptation".

Lisboa, January 2003
Sandra Gadanho, Ph.D.
Instituto de Sistemas e Robótica
Instituto Superior Técnico

3.3 THESES

In this section the Doctoral and Master theses concluded, or in progress, during 2002 at ISR-Lisbon are identified. In Charts 1 and 2 below the distribution by group/area of Ph.D. and M.Sc. theses is displayed.

CHART 1

Ph.D. Theses

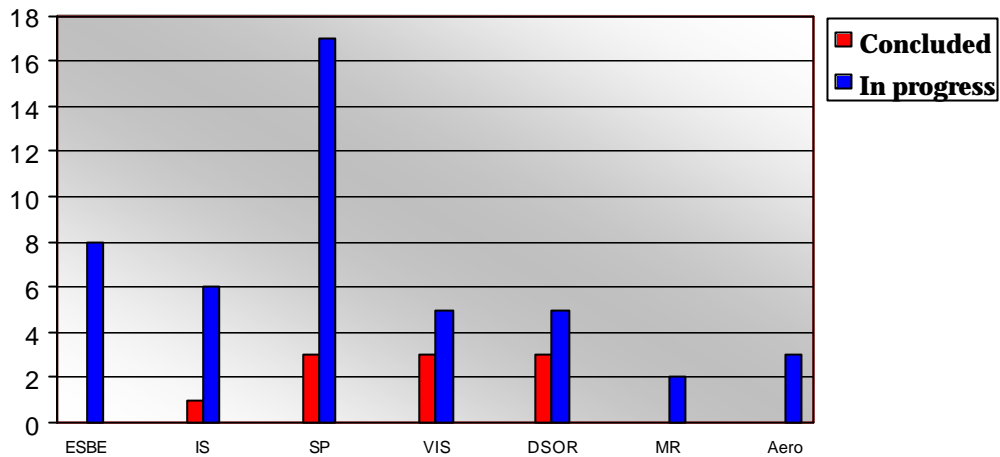
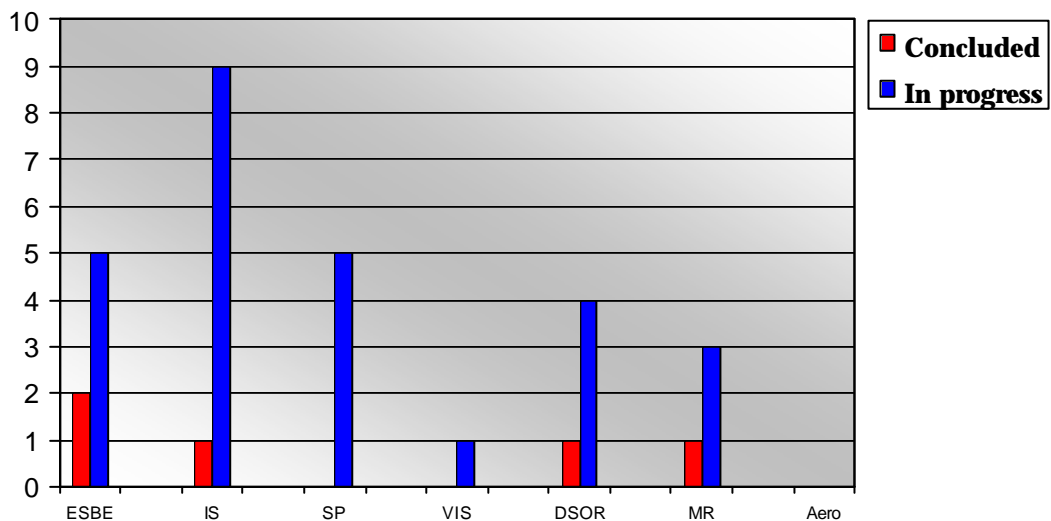

CHART 2

M.Sc. Theses



In the following a more detailed description of each thesis is given.

3.3.1 THESES CONCLUDED DURING 2002

DOCTORAL THESES (10)

Niall Winters, "A Holistic Approach to mobile Robot Navigation using Omni directional Vision," Ph.D. Thesis, Trinity College, January 2002, Dublin, Ireland.

Abstract:

This dissertation presents a novel methodology for vision-based robot navigation. One of the key observations is that navigation systems should be designed through a holistic approach, encompassing aspects of sensor design, choice of adequate spatial representations with associated global localization and local control schemes.

We tackle a number of design issues. Taking inspiration from biology, where wide field-of-views are common, we use an Omnidirectional camera. This gives us a 360° horizontal view of the environment.

An appropriate environmental representation is a key element for successful navigation. We argue that emphasis should be placed on building the appropriate representation rather than relying on highly accurate information about the environment.

Since our robot is designed to travel long distances, we choose a topological environmental representation. The topological map is encoded by a low-dimensional eigen space obtained via Principal Component Analysis. We detail a local control scheme which allows our robot to effectively use the environmental representation for qualitative localization.

Finally, we present a method termed, Information Sampling which calculates the most discriminating information within the environment traversed by the mobile robot. By developing a method which allows the robot to focus its attention on this data, it is better able to make effective use of its (limited) computational resources. This enables it to more efficiently handle the complexity of the reception process.

Keywords:

Omni-directional vision, mobile robot navigation, topological navigation, vision based control

Members of the thesis committee:

Prof. Vergil Shavlin, Trinity College (IRL)

Prof. James Crowley, INRIA/INPG (F)

Prof. John Byrne, Trinity College, (IRL)

Paulo Tabuada "Hierarchies and Compositional Abstractions of Hybrid Systems" Instituto Superior Técnico, January 2002, Portugal.

Abstract:

In the last decade an increasing attention has been paid to the modeling, analysis and control of large-scale, embedded, complex systems. The impulse from the application side has been tremendous and includes among others automotive engines, air-traffic management systems, chemical plants, manufacturing systems, TCP congestion control and biomolecular networks. It is fair to say that embedded systems are now everywhere where we mean by embedded systems all those applications where computing systems interface the continuous world through sensors and actuators. The advances and the low cost of new and more powerful computing, sensing and communicating devices push further the limits of what is now possible to accomplish. Today's applications have gone way beyond the formal and theoretical understanding we have about those systems. In fact, designing embedded systems is a very difficult task since several different domain specific techniques must be combined together. Software engineering and concurrency theory techniques as well as real-time scheduling need to meet signal processing and control theory to

accommodate the needs of embedded systems. These difficulties call for a formal approach. In this spirit we regard Hybrid Systems as a formal model for embedded systems since it allows to specify both the continuous (real world) as well the discrete (some form of computation) dynamics.

In this work we introduce an abstract framework for the study of control systems capturing continuous, discrete and hybrid control systems. A notion of abstraction is defined for hybrid control systems which can be regarded as a quotient system that preserves properties of interest while ignoring modeling details. Special attention is devoted to large scale systems which are usually built by interconnecting smaller subsystems. A formal notion of compositionality is also introduced to model the interconnection and synchronization of subsystems. It is shown that the the notion of abstraction is compositional in the sense that by composing of abstractions of subsystems one obtains an abstraction of the overall system. An algorithm is proposed to effectively compute abstractions of hybrid control systems which provide a useful tool to deal with the inherent complexity of embedded systems. These results perspectivates a hierarchical methodology to perform analysis and design tasks for hybrid control system by exploiting the different layers in a hierarchy of compositional abstractions.

Keywords:

Hybrid Systems, abstractions, embedded systems, large-scale systems, robot formations.

Members of the thesis committee:

Prof. George Pappas, University of Pennsylvania (USA)

Prof. Fernando Lobo Pereira, FEUP (P)

Prof^a Ana Cannas da Silva, DM/IST (P)

Prof. António Pascoal, DEEC/IST (P)

Prof. Joao Sequeira, DEEC/IST (P)

Prof. Pedro Lima, DEEC/IST (P)

António Pedro Aguiar, “Nonlinear Motion Control of Nonholonomic and Underactuated Systems,” Instituto Superior Técnico, April 2002, Portugal.

Abstract:

This thesis addresses the problem of stabilization of nonholonomic and underactuated systems. The key motivation for this research topic stems from the fact that nonholonomic systems pose considerable challenges to control system designers since those systems cannot be stabilized by smooth, time-invariant, state-feedback control laws. Furthermore, in spite of the number of methods available for the control of nonholonomic and underactuated mechanical systems, few address important practical topics such as the explicit inclusion of dynamics in the control problem formulation and the need to cope with model parameter uncertainty and external disturbances. This thesis tackles some of these issues, formulates and solves the related control problems, and discusses the application of the new control methodologies derived to robotic land and underwater vehicles.

The first part of the thesis focuses on the control of the so-called extended nonholonomic double integrator (ENDI), which captures the kinematics and dynamics of a class of mobile robots. A solution to the problem of global stabilization of the ENDI is given that builds on logic-based hybrid control. The methodology derived is applied to the problem of stabilizing the dynamic model of an underactuated autonomous underwater vehicle (AUV) to a desired pose.

The second part of the thesis is devoted to the problem of steering a wheeled mobile robot and an underactuated AUV to a target point with a desired orientation, in the presence of parametric modeling uncertainty. Controller design relies on non-smooth coordinate transformations in the original state space, followed by the derivation of adaptive, smooth, time invariant feedback control laws in the new coordinates. The problem of positioning and way-point tracking of an underactuated AUV in the presence of an unknown ocean current disturbance is also investigated and solved using a similar approach.

The last part of the thesis is devoted to the general problem of nonlinear system stabilization. A new controller design methodology is presented for a large class of nonlinear systems that builds on recently developed switching hybrid control techniques and classical Lyapunov based design tools.

Throughout the thesis, formal proofs of convergence of the algorithms derived are presented. Simulation results obtained with full nonlinear models of representative land and underwater robots are discussed.

Keywords:

Underactuated and Nonholonomic Systems, Hybrid Control, Nonlinear and Adaptive Control, Convergence and Stability Analysis, Autonomous Wheeled Mobile Robots, Autonomous Underwater Vehicles.

Members of the thesis committee:

Prof. Giovanni Indiveri, Univ. Lecci, (I)

Prof. João Sentieiro, Instituto Superior Técnico, (P)

Prof. João Lemos, Instituto Superior Técnico, (P)

Prof. Fernando Lobo Pereira, Faculdade de Engenharia da Universidade do Porto, (P)

Prof. José Sá da Costa, Instituto Superior Técnico, (P)

Prof. António Pascoal Instituto Superior Técnico, (P)

Prof. Pedro Lima, Instituto Superior Técnico, (P)

João Maciel, " Global Matching: optimal solution to correspondence problems," Ph.D. Thesis, Instituto Superior Técnico, April 2002, Lisboa, Portugal.
--

Abstract:

In this thesis we propose a new methodology to reliably solve the correspondence problem between points on image sequences. This is a key step in most problems of Computer Vision and, so far, no general method exists to solve it. Our methodology is able to handle most of the commonly used assumptions in a unique formulation, independent of the domain of application and type of features. It performs correspondence and outlier rejection in a single step, and achieves global optimality with feasible computation.

Feature selection and correspondence are formulated as an integer optimization problem. To find its global optimal solution we build a concave objective function and relax the search domain into its convex-hull. The special structure of this extension assures its equivalence to the original problem, and it can be optimally solved by efficient algorithms that avoid combinatorial search.

This formulation has the advantage of allowing the use of global criteria, which consider the whole set of features and the whole set of possible correspondences, instead of one isolated pair of points at a time. We develop explicit polynomial cost functions for a few global criteria, and use them in our methodology.

One such criterion is rigidity. Rigidity is the main assumption used in 3D reconstruction by triangulation, but it is not often used for correspondence. Shape extraction and point correspondence are treated, usually, as two different computational processes. We consider the rigidity criterion in fully uncalibrated scaled-orthographic image sequences.

Correspondences are set such that they optimize the same criterion used to compute shape and motion by the factorization method.

Keywords:

Computer Vision, Correspondence Problem, Feature Matching, Structure from Motion, Concave Minimization, Optimization.

Members of the thesis committee:

Prof. José Manuel Fonseca de Moura, CMU, (USA)

Prof. Takeo Kanade, CMU, (USA)

Prof. João José dos Santos Sentieiro, IST (P)

Prof. José Alberto Rosado dos Santos Victor, IST, (P)

Prof. João Paulo Salgado Arriscado Costeira, IST, (P)

Prof. José Manuel Bioucas Dias, IST, (P)

Prof. Pedro Manuel Quintas Aguiar, IST, (P)

Pedro Encarnação, “Nonlinear Path Following Control Systems for Ocean Vehicles,” Instituto Superior Técnico, April 2002, Portugal.

Abstract:

A new methodology is proposed for the design of path following systems for surface and underwater autonomous ocean vehicles in the presence of constant but unknown ocean currents. Convergence to reference paths is achieved with a nonlinear control strategy that takes explicitly into account the dynamics of the vehicle as well as those of a current estimator. Formal convergence proofs are indicated. Simulation results with the models of prototype ocean vehicles are presented to illustrate the performance of the path following system derived.

Additionally, the thesis presents a solution to the problem of combined trajectory tracking and path following for underactuated vehicles with non-negligible dynamics. The methods described borrow from and extend previous work by Hindman and Hauser on so-called maneuver modified trajectory tracking. Lyapunov based and backstepping techniques are used. Simulations with models of a wheeled mobile robot, an underactuated surface craft, and a fully actuated underwater vehicle are presented as application examples of the combined trajectory tracking and path following controllers. The same circle of ideas is applied to develop a control system for the coordinated operation of a surface craft and an underwater vehicle that are required to follow the same reference path at different depths so as to ensure a direct vertical channel for acoustic communications between the two vehicles.

Keywords:

Autonomous vehicles; path following; trajectory tracking; nonlinear control; Lyapunov-based design; backstepping techniques.

Members of the thesis committee:

Prof. Giovanni Indiveri, Univ. Lecci, (I)

Prof. João Sentieiro, Instituto Superior Técnico, (P)

Prof. João Lemos, Instituto Superior Técnico, (P)

Prof. Fernando Lobo Pereira, Faculdade de Engenharia da Universidade do Porto, (P)

Prof. José Sá da Costa, Instituto Superior Técnico, (P)

Prof. António Pascoal Instituto Superior Técnico, (P)

Prof. Pedro Lima, Instituto Superior Técnico, (P)

João Pedro Castilho Pereira Santos Gomes “Array Processing Methods for Time-Reversed Underwater Communication Systems”, July 2002, Instituto Superior Técnico, Portugal.

Abstract:

The automatic multipath compensation property of time-reversal mirrors is highly relevant for underwater acoustic telemetry, allowing receivers to be simplified at the expense of increased transmitter hardware complexity. Recognizing the current scarceness of results on specific applications of time-reversal arrays in communications, this

thesis adopts a broad perspective and addresses several issues that are pertinent when designing mirror-based coherent data links.

After developing an understanding of the focusing process in terms of beamforming concepts, it is shown that design techniques for nonuniformly spaced arrays can still be used in the ocean waveguide, allowing the number of sensors to be reduced relative to a uniform mirror without compromising the focusing power.

Taking advantage of the bidirectional nature of data links, the basic protocol for coherent time-reversed communication is modified to incorporate pulse estimation from incoming packets, thereby improving the noise robustness. This channel identification block can be efficiently shared by the receive and transmit sections of a two-way mirror.

By decomposing the spatial and temporal signatures of incoming wavefronts at the mirror it is possible to send several messages in parallel over distinct propagation paths. This form of spatial modulation creates an equivalent multiple-input single-output channel with low delay distortion, where some of the coding techniques developed for wireless Rayleigh fading channels can be used. Although modeling assumptions can be incorporated into the wavefront detection and extraction process, the resulting spatial modulation masks preserve the ability of plain mirrors to operate in poorly characterized environments. This approach is extended to the case of a moving source.

Simulation results illustrate the proposed methods, and the main impairments to be overcome in practical implementations are identified and discussed.

Keywords:

Underwater acoustic communication, phase conjugation, time-reversal mirrors, spatial modulation, multipath compensation, transmit arrays

Members of the thesis committee:

Prof. Milica Stojanovic, Massachusetts Institute of Technology (USA)

Prof. Sérgio Manuel Machado de Jesus, Universidade do Algarve (P)

Prof. Victor Alberto Neves Barroso, IST, UTL (P)

Prof. José Manuel Bioucas Dias, IST, UTL (P)

Prof. Maria João Torres Dolores Rendas, Laboratoire I3S, CNRS (F)

Paulo Oliveira, "Periodic and Non-Linear Estimators with Applications to the Navigation of Ocean Vehicles," Instituto Superior Técnico, July 2002, Portugal.

Abstract:

This thesis addresses the problem of estimator design to be used as navigation and target tracker systems in autonomous vehicles. Both synthesis and analysis steps are supported by Linear Matrix Inequalities (LMIs), a framework able of describing convex optimization problems. Solutions are found resorting to efficient commercially available interior-point optimization tools. Complementary filters were chosen as the structure to formulate all problems addressed and solved along this work due to their key properties. Namely, the frequency domain interpretation provides valuable insight into the filtering design process.

New results on the H2 norm computation of discrete-time periodic time-varying systems are deduced, based on a set of LMIs written along the systems period and a new methodology for estimator design is introduced, which extends the complementary filters properties to this class of systems. Complementary filter properties are also extended to the time-varying setting by resorting to the theory of linear differential inclusions. The stability and performance properties of the navigation systems obtained are studied in both cases. A new methodology for system analysis using efficient numerical analysis tools that borrow from convex optimization techniques is introduced, allowing for assessment of the "frequency-like" performance of the filters obtained.

Finally, to provide estimates on the position and velocity of an Autonomous Underwater Vehicle (AUV) relative to an Autonomous Surface Craft (ASC), two non-linear target trackers are designed, based on two alternative sensor suites. To that purpose, two non-linear estimators are proposed and studied in detail, resorting to linear parametrically time-varying (LPV) systems. Stability and regional performance of the resulting target trackers are guaranteed and the complementary filters properties are verified.

Keywords:

Navigation Systems, Non-linear Target Trackers, Complementary Filters, Periodic Systems, Autonomous Vehicles, LMIs.

Members of the thesis committee:

Prof. Isaac Kaminer, Naval Postgraduate School, Monterey, CA, (USA)

Prof. José Leitão, Instituto Superior Técnico, (P)

Prof. Carlos Rocha, Instituto Superior Técnico, (P)

Prof. João Lemos, Instituto Superior Técnico, (P)

Prof. Fernando Lobo Pereira, Faculdade de Engenharia da Universidade do Porto, (P)

Prof. Maria Isabel Ribeiro, Instituto Superior Técnico, (P)

Prof. António Pascoal Instituto Superior Técnico, (P)

Paulo Mónica Oliveira, " Physical Constraints on the Time-Frequency Plane " Ph.D. Thesis, Instituto Superior Técnico, July , Lisboa, Portugal.

Abstract:

Representing signals in the Time-Frequency plane is a difficult and often paradoxical task. The concept of Instantaneous Frequency (IF) is a paradigm of this. With the current definition, the obtained values for the IF are, most of the times, physically unacceptable. Clarification of the concept of IF is one of the tasks that this thesis tries to accomplish. The reasons for failure of the traditional definition of IF will be determined. The conditions under which it provides acceptable results will be obtained. An alternative definition of IF will be proposed.

Another difficulty lies on the issue of time-frequency resolution. The existence/non existence of limits to the resolution achievable within the time-frequency plane is still an open question, which will be discussed. We will be led to the conclusion that there are, indeed, limits to the resolution within the time frequency-plane, imposed by the signal's frequency dynamics.

Some additional results and algorithms are also presented. A novel procedure for sequential extraction of the individual components of multicomponent polynomial phase signals, a new algorithm for determination of Instantaneous Frequency, and a spectral procedure for numerical differentiation of discrete data sequences. The performance of these algorithms in the presence of noise is discussed. Several examples will be given, with both real and synthetic data.

Keywords:

Instantaneous frequency, time-frequency analysis, frequency resolution, uncertainty relations, spectral analysis, time-frequency plane.

Members of the thesis committee:

Prof. Xiang-Gen Xia, University of Delaware (USA)

Prof. Paulo Alexandre Andrade Gonçalves, INRIA, Rhone-Alpes (FR)

Prof. Luís Henrique Martins Borges de Almeida, IST, (P)

Prof. Victor Alberto Neves Barroso, IST, (P)

Prof. Mário Alexandre Teles de Figueiredo, IST, (P)

Etienne Grossmann, " Maximum Likelihood 3D Reconstruction from one or more Uncalibrated Views under Geometric Constraints," Ph.D. Thesis, Instituto Superior Técnico, October 2002, Lisboa, Portugal.

Abstract:

We consider the problem of tridimensional reconstruction obtained from one or more images, when the 2D perspective projections of 3D points of interest are available, together with some geometric properties, such as planarities, alignments, symmetries, known angles between directions etc. Because these geometric properties occur mostly in man-made environments and objects, the presented method applies mostly to these cases.

The method has two phases. In the first, the reconstruction problem is transformed into one of linear algebra, and the solutions to the initial problem are identified with that of the second. Thus, examining the dimension the space of solutions allows to determine whether the provided information is sufficient to uniquely define a reconstruction.

In the second phase, the framework of maximum likelihood estimation is used. The reconstruction problem is transformed into a problem of unconstrained optimization by using a differential parameterization of the 3D points subject to geometric constrained.

These two techniques combine into a reconstruction method that improves over the current state-of-the-art by offering a great flexibility of use and by providing a reconstruction that is statistically characterized. The method is benchmarked using synthetic and real-world data.

Keywords:

Computer vision, photogrammetry, 3D reconstruction, single-view reconstruction, maximum likelihood, geometric constraints.

Members of the thesis committee:

Dr. Rachid Deriche, Directeur de recherches, INRIA (F)
Prof. Jorge Manuel Miranda Dias, Univ. Coimbra (P)
Prof. João José dos Santos Sentieiro, IST, (P)
Prof. Mário Alexandre Teles de Figueiredo, IST, (P)
Prof. Pedro Manuel Quintas Aguiar, IST, (P)
Prof. José Alberto Rosado Santos-Victor, IST, (P)

João Xavier, "Blind Identification of MIMO Channels Based on 2nd Order Statistics and Colored Inputs," Ph.D. Thesis, Instituto Superior Técnico, December 2002, Lisboa, Portugal.

Abstract:

We study blind identification of multiple-input multiple-output (MIMO) systems based only on 2nd order statistics (SOS).

This problem arises naturally in many applications, for example, SDMA (Space Division Multiple Access) networks for wireless

multi-user communications. The problem of SOS-based blind MIMO channel identification is not strictly well-posed. At least, a phase ambiguity per input cannot be avoided. But other, more severe, channel ambiguities may also exist. We take the viewpoint of modeling the unavoidable phase ambiguities as an equivalence relation in the set of MIMO channels. We partition the set of MIMO channels in disjoint equivalence classes and work solely with this quotient space (the set of equivalence classes) throughout the thesis.

We prove an identifiability theorem which shows that, under a certain spectral diversity condition on the input random signals, the

MIMO channel equivalence class is uniquely determined by the output SOS. Although the proof of the identifiability theorem is not constructive, we develop a closed-form algorithm which achieves the predicted identifiability bound.

We show that the sufficient input spectral diversity condition can be easily induced by placing a coloring pre-filter at each transmitter.

To achieve an optimal design for the pre-filters, we carry out an asymptotic performance analysis of our closed-form algorithm.

Since we deal with an inference problem over a quotient space, our case is not covered by the standard theory used in Euclidean contexts. Instead, a Riemannian structure is induced in the quotient space and we set up some intrinsic theoretical tools to cope with this manifold setting. To place a fundamental limit on the MIMO channel equivalence estimate quality, we also present an extension of the Cramér-Rao bound to this Riemannian setup.

Keywords:

Blind channel identification, Multiple-input multiple-output systems, Second-order statistics, Colored inputs, Performance Analysis, Riemannian geometry.

Members of the thesis committee:

Prof. Louis Scharf, University of Colorado, (USA)

Dr. John Cozzens, NSF Program Director, Signal Processing Systems, Division of Computer-Communication (USA)

Prof. José Manuel Fonseca de Moura, CMU, (USA)

Prof. Luís Henrique Martins Borges de Almeida, IST, (P)

Prof. João José dos Santos Sentieiro, IST, (P)

Prof. Victor Alberto Neves Barroso, IST, (P)

MASTER THESES (5)

**João da Silva Gomes-Mota “Localisation of a Mobile Robot using Laser Scanner and Reconstructed 3D Models”
Instituto Superior Técnico, May 2002, Portugal**

Abstract:

This dissertation presents a novel procedure for the localisation of a mobile robot, supported on distance profiles acquired with a laser range scanner. The localisation system is embarked on a mobile robot, whose main task is to acquire and reconstruct a 3D map of large indoor environments.

No prior knowledge or a priori constraints of the environment map are known or assumed for localisation purposes. At each stage of the reconstruction procedure the environment map is known up to the extent it has already been reconstructed.

The main contributions of this dissertation are two algorithms and one dedicated statistics. The first algorithm, named Frame Localisation, is based on natural feature extraction. It uses no a priori estimate of the robot's position and produces a reasonably good position estimate. The second algorithm, named Approximate Localisation, provides a refined position estimate based on an initial estimate or the results of the first algorithm. It compares the scene's range profile with the reconstructed map and computes a maximum likelihood fit. The statistics measures the quality of the computed posture estimates, providing a quantitative performance criterion.

This dissertation presents experimental relevant results, obtained during real 3D acquisition campaigns on different types of indoor environments.

Keywords:

Mobile Robot Localisation, Laser Scanner, 3D Scene Reconstruction, Frame Localisation

Members of the thesis committee:

Prof. Maria Isabel Lobato de Faria Ribeiro, IST, (P)

Prof. Jorge Manuel Miranda Dias, University of Coimbra, (P)

Prof. José Alberto Rosado dos Santos Victor, IST, (P)

**Rui Melo Tavares, “Algoritmos Evolutivos: Paradigma Infecção Genética” MSc Thesis, Instituto Superior Técnico,
April 2002, Lisboa, Portugal.**

Abstract:

In this work, the systematic inclusion of domain specific knowledge in the variation process of an Evolutionary Algorithm is researched. A new instance of the general concept is created, named Infected Genes Evolutionary Algorithm, which uses information gathered in the phenotype to bias the variation process. Its domain of applicability is characterised, and a reasoning supporting its adequacy to constraint optimisation problems is presented. As an example of a real world problem solved using the concept, a high school timetable scheduling application is reported. A case study is also presented to probe the concept's effectiveness and limitations. The Infected Genes Evolutionary Algorithm displays an intrinsic self-regulating property, as far as variation rules are concerned. In this way, a link to another open problem in Evolutionary Computation is established, namely strategy parameter control. A brief state-of-the-art survey is presented, as well as an original contribution targeted at the study and understanding of the dynamical control of population size. This study clarifies and stresses the difficulties of using parameter control strategies in general.

Keywords:

Evolutionary Algorithms, Evolutionary Computation, Genetic Algorithms, Parameter Control, Population Size, Phenotype Information, Gene Expression, Performance Measures.

Members of the thesis committee:

Prof. Luis Correia, Instituto Superior Técnico, (P)

Prof Luis Custódio, Instituto Superior Técnico, (P)

Prof Agostinho Rosa, Instituto Superior Técnico, (P)

Carlos Fernandes, “Population based Genetic Algorithms”, MSc Thesis, Instituto Superior Técnico, April 2002, Lisboa, Portugal.

Abstract:

In this work a study on the effects of non-random mating in Genetic Algorithms (GAs) performance is presented. It is shown that a GA with a new mating strategy based on genotype similarities between chromosomes maintains the genetic diversity of the evolving populations at a higher level and outperforms simple GA in some case studies. With this mating strategy, based on the behavior of some natural species, the chromosomes with high similarity have less chance of mating. It is also shown that the mechanisms of non-random mating are even more effective when combined with populations of varying size.

The new mating strategy maintains diversity by decreasing the rate of crossovers between similar individuals and not by randomly introducing new genetic material in the population as it happens with the mutation operator. This allows the algorithm to attain genetic diversity levels similar to those obtained by the simple GA with high mutation rate but without the performance decrease observed in such GAs.

In a more specific case, the non-random mating strategy was applied to a GA with simple inversion. The results showed that the resulting algorithm needs no mutation to converge to global optima in all the runs with fewer evaluations than any other GA.

Keywords:

Genetic Algorithms, non-random Mating, Varying Population Size, Genetic Diversity, Simple Inversion Operator, Incest Prohibition

Members of the thesis committee:

Prof. Fernando Lobo Pereira, FEUP (P)

Prof. Ana Fred, Instituto Superior Técnico (P)

Prof. Agostinho Rosa, Instituto Superior Técnico (P)

Rita Cunha, “Modeling and Control of an Autonomous Robotic Helicopter,” Instituto Superior Técnico, July 2002, Portugal.

Abstract:

This thesis addresses the problems of dynamic modeling and path following controller design, for autonomous helicopters. The model is directed towards small scale unmanned helicopters, such as the Vario X-Treme, currently being used as a research testbed at the Instituto Superior Técnico. Recent advances on gain scheduling control theory are used to develop a path following controller for steering the helicopter along prescribed paths.

The first part of the thesis introduces a generic dynamic model for an n-bladed single main rotor helicopter. The helicopter is modeled as a six degrees of freedom rigid body, actuated by forces and moments which are generated at the main and tail rotors, fuselage, and empennage. The model focuses specially on the subjects of rotary-wing dynamics and aerodynamics, and includes the modeling of Bell-Hiller servo-rotors.

The second part of the thesis presents the design of an integrated guidance and control system for accurate path following. The design process follows the standard sequence of steps: i) selection of a set of relevant trimming paths, ii) linearization of the model about the selected trimming paths, iii) design of a linear path following controller for each linear model, iv) implementation of the resultant non-linear path following controller using the gain scheduling technique. The performance of the overall closed loop system is assessed in simulation.

Keywords:

Autonomous helicopters; Dynamic modeling; Bell-Hiller servo-rotor modeling; Path following; Control; Guidance.

Members of the thesis committee:

Prof. Keith Woodgate, Imperial College of Science and Technology, (UK)

Prof. António Pascoal, Instituto Superior Técnico, (P)

Prof. Afzal Suleman, Instituto Superior Técnico, (P)

Prof. Carlos Silvestre, Instituto Superior Técnico, (P)

João Pina “Operation and Control of a Glass Melting Furnace” Instituto Superior Técnico, November 2002 , Portugal

Abstract:

Glass industry is the paradigm of a very conservative industry in a world of constant technological evolution and cultural transformation. Quality glass production, as any other product, must be made in an environmental, economical and social perspective. This leads to a process global analysis, which includes, for instance, furnace design or the choice of fuels and raw materials, including the crucial aspect of furnace operation with a view to its performance optimisation. This is the main question of this thesis, which involves a detailed process study, in order to define evaluation criteria of such a performance. The attainment of multiple criteria, or objectives, some of them concurrent, led naturally to the application of techniques and formalisms from the field of multiobjective optimisation, together, in this case, with Genetic Algorithms. On the other hand, the need to employ furnace models, in order to evaluate different furnace configurations, involved the knowledge acquisition and systematisation through the real process, having been applied a Fuzzy Logics based on a learning by examples mechanism. All this concepts were integrated on an industrial process operation system, whose architecture is described in this document.

Keywords:

Industrial Processes Operation Architecture, Glass Furnaces, Fuzzy Logic, Genetic Algorithms, Multiobjective Optimisation, Learning by Examples.

Members of the thesis committee:

Prof. Manuel Heitor, DEM/IST, (P)

Prof. João Miranda Lemos, DEEC/IST, (P)

Prof. António Ruano, FCT/U. Algarve, (P)

Prof. Pedro Lima, DEEC/IST, (P)

3.3.2 THESES IN PROGRESS DURING 2002

In this subsection the Doctoral and Master theses in progress during 2002, at ISR/IST (ECE) and ISR/Algarve (ECE), are identified and ordered by the scientific research area.

DOCTORAL THESES (46)

Research Area: Artificial Intelligence
Title: Spatial Reasoning – The N-Dimensional Projective Approach
Doctoral Student: Jorge Miguel Pais
Advisor: Carlos Alberto Pinto-Ferreira
Initiated: 1997
Expected conclusion: 2003
Current Status: On-going
Grant:
Documents produced in 2002:

Research area: Artificial Intelligence
Title: Emotion-based Agents
Doctoral Student: Rodrigo Ventura
Advisor: Carlos Alberto Pinto-Ferreira
Initiated: 2001
Expected conclusion: 2004
Current status: On-going
Grant:
Documents produced in 2002: [79] , [80]

Research area: Artificial Intelligence
Title: Reasoning under Uncertainty in a Multi-Agent System
Doctoral Student: M. M. Vijay Sargunar
Advisor: Luis Manuel Marques Custódio
Initiated: 2002
Expected conclusion: 2005
Current status: On-going
Grant:
Documents produced in 2002:

Research Area: Biological Systems, Stochastic Hybrid Systems
Title:
Doctoral Student: Dejan Milutinovic
Advisor: Pedro M. U. A. Lima
Initiated: September 2000
Expected conclusion: 2004
Current Status: On-going
Grant:
Documents produced in 2002: [76] , [163]

Research Area: State Estimations for Satellite Formations

Title:

Doctoral Student: Sónia Marques

Advisor: Pedro M. U. A. Lima

Initiated: September 2001

Expected conclusion: 2005

Current Status: On-going

Grant:

Documents produced in 2002: [71]

Research Area: Formation Control

Title:

Doctoral Student: Andrés García

Advisor: Pedro M. U. A. Lima

Initiated: March 2002

Expected conclusion: 2006

Current Status: On-going

Grant:

Documents produced in 2002:

Research Area: Computer Vision

Title: Binocular Visual Servoing and Visual attention

Doctoral Student: Alexandre Bernardino

Advisor: José Santos-Victor

Initiated: 1997

Expected conclusion: 2003

Current Status: On-going

Grant:

Documents produced in 2002: [24] , [39] , [40] , [113]

Research Area: Computer Vision

Title: Visual Navigation based on Panoramic Image sensors

Doctoral Student: José António Gaspar

Advisor: José Santos-Victor

Initiated: 1997

Expected conclusion: 2003

Current Status: submitted

Grant:

Documents produced in 2002: [121]

Research Area: Computer Vision

Title: Video Mosaics for Navigation

Doctoral Student: Nuno Gracias

Advisor: José Santos-Victor

Initiated: 1998

Expected conclusion: 2003

Current Status: Submitted

Grant: PRAXIS XXI

Documents produced in 2002:

Research Area: Computer Vision
Title: Vision based Imitation
Doctoral Student: Manuel Cabido Lopes
Advisor: José Santos-Victor
Initiated: 2002
Expected conclusion: 2004
Current Status: On-going
Grant:
Documents produced in 2002:

Research Area: Computer Vision
Title: Image matching
Doctoral Student: Ricardo Oliveira
Advisor: João Paulo Costeira
Initiated: 2002
Expected conclusion: 2004
Current Status: On-going
Grant:
Documents produced in 2002:

Research Area: Biomedical Engineering
Title: Sleep EEG Microstructure Analysis
Doctoral Student: Rogério Largo
Advisor: Agostinho Rosa
Initiated: 1996
Expected conclusion: 2003
Current Status: on-going
Grant: PRODEP
Documents produced in 2002:

Research Area: Evolutionary Systems - Scheduling
Title: Simulated Annealing in Resource Management
Doctoral Student: Fernando Melicio
Advisor: Agostinho Cláudio da Rosa
Initiated: 1998
Expected Conclusion: 2002
Current Status: on-going
Documents produced in 2002:

Research Area: Evolutionary Systems – Optimization and Image Enhancement
Title: AREA on-line decision EA
Doctoral Student: Cristian Munteanu
Advisor: Agostinho Cláudio da Rosa
Initiated: Jan 2001
Expected Conclusion: 2003
Current Status: on-going
Grant: FCT
Documents produced in 2002:

Research Area: Artificial Life – Evolutionary Systems

Title:

Doctoral Student: Gong Hongfei

Advisor: Agostinho Cláudio da Rosa

Initiated: October 1999

Expected Conclusion: 2004

Current Status: on-going

Grant: FCT

Documents produced in 2002:

Research Area: Artificial Life – Social Systems

Title: Design and Development of Highly Flexible Organizations

Doctoral Student: Osvaldo Brasão

Advisor: Agostinho Cláudio da Rosa

Initiated: July 1999

Expected Conclusion: 2003

Current Status: on-going

Grant: FCT

Documents produced in 2002:

Research Area: NeuroSciences

Title:

Doctoral Student: Ernesto Soares

Advisor: Agostinho Cláudio da Rosa

Initiated: July 1999

Expected Conclusion: 2003

Current Status: on-going

Grant: Calouste Gulbenkian Foundation

Documents produced in 2002:

Research Area: Biomedical Engineering - Neuroscience

Title: Detection of Neurocognitions

Doctoral Student: Jose Luis Malaquias

Advisor: Agostinho Cláudio da Rosa

Initiated: September 2000

Expected Conclusion: 2004

Current Status: on-going

Grant:

Documents produced in 2002:

Research Areas: Biomedical Engineering - vision

Title: Objects representation and identification

Doctoral Student: Tito Silva

Advisor: Agostinho Cláudio da Rosa

Initiated: 1997

Expected Conclusion: 2003

Current Status: Delivered

Grant: PRAXIS XXI

Documents produced in 2002:

Research Area: Outdoors Navigation of Mobile Robots
Title: Not yet available
Doctoral Student: Alberto Vale
Advisor: Maria Isabel Ribeiro
Initiated: December 1999
Expected conclusion: 2004
Current Status: on-going
Grant: SFRH/BD/929/2000 from FCT
Documents produced in 2001: [92]

Research Area: Cooperative Navigation
Title: Not yet available
Doctoral Student: Fernando Melo
Advisor: Maria Isabel Ribeiro
Initiated: December 2002
Expected conclusion: 2005
Current status: on - going
Grant: PhD grant from FCT
Documents produced in 2002:

Research Area: Telecommunications
Title: Not yet available
Doctoral Student: Emanuel Ribeiro
Advisor: Victor Barroso
Initiated: 2001
Expected conclusion: 2004
Current status: on-going
Grant: PT Internacional
Documents produced in 2002:

Research Area: Image Compression
Title: Compressão de Vídeo para Aplicações Submarinas
Doctoral Student: Jorge Barbosa
Advisor: Victor Barroso
Initiated: 1996
Expected conclusion: 2003
Current Status: manuscript reviewing
Grant: PRODEP
Documents produced in 2002:

Research Area: Space/Time Coding
Title: Not yet available
Doctoral Student: Marko Beko
Advisor: Victor Barroso
Initiated: 2002
Expected conclusion: 2005
Current Status: on-going
Grant: ISR programmatic funding
Documents produced in 2002:

Research Area: Queuing Networks
Title: Not yet available
Doctoral Student: Nuno Manuel Rosa dos Santos Órfão
Advisor: Carlos Bispo
Initiated: 2002
Expected conclusion: 2005
Current Status: on-going
Grant:
Documents prepared in 2002:

Research Area:
Title: Not yet available
Doctoral Student: Dusan Ramljak
Advisor: Victor Barroso
Initiated: 2001
Expected conclusion: 2004
Current Status: on-going
Grant:
Documents produced in 2002:

Research area: Video Segmentation
Title: Not yet available
Doctoral Student: Pedro M. Jorge
Advisor: Jorge S. Marques
Initiated: 1998
Expected conclusion: 2004
Current status: on going
Grant:
Documents produced in 2002:

Research Area: 3D Ultrasound
Title: Reconstrução 3D bayesiana a partir de sequências ecográficas
Doctoral Student: João Sanches
Advisor: Jorge S. Marques
Initiated: 1998
Expected conclusion: 2003
Current Status: finished, waiting for defence
Grant:
Documents prepared in 2002: [44] , [45] , [101] , [107] , [139] , [164]

Research Area: Tracking of Moving Objects
Title: Robust Shape Estimation and Tracking in the Presence of Clutter
Doctoral Student: Jacinto Nascimento
Advisor: Jorge S. Marques
Initiated: 1998
Expected conclusion: 2003
Current Status: finished, waiting for defence
Grant: PRAXIS XXI
Documents prepared in 2002: [42] , [138] , [165]

Research area: image processing, visual psychophysics
Title: A new spatial brightness model
Doctoral Student: João Rodrigues
Advisor: Hans du Buf
Initiated: 1998
Expected conclusion: 2002
Current status: on going
Grant: PRODEP
Documents produced in 2002:

Research area: Processamento de Imagem em 3D
Title: 2D and 3D data Processing and visualization
Doctoral Student: Robert Loke
Advisor: Hans du Buf
Initiated: 1998
Expected conclusion: 2003
Current status: on going
Grant: European project ADIAC ans ISACS
Documents produced in 2002:

Research area: Processamento de Imagem
Title: Models of cortical neurons in pattern recognition
Doctoral Student: Luis Santos
Advisor: Hans du Buf
Initiated: 2000
Expected conclusion: 2004
Current status: on going
Grant: FCT
Documents produced in 2002:

Research area: Computação Gráfica
Title: 3D object Reconstruction and Triangulation
Doctoral Student: Roberto Lam
Advisor: Hans du Buf
Initiated: 2001
Expected conclusion: 2005
Current status:
Grant:
Documents produced in 2002:

Research area: Processamento de Imagem
Title: Detection and brightness modes
Doctoral Student: Pedro Guerreiro
Advisor: Hans du Buf
Initiated: 2001
Expected conclusion: 2005
Current status: on going
Grant:
Documents produced in 2002:

Research area: Tomographic Data Assimilation
Title: Data Fusion Applied to Ocean Acoustic Tomography
Doctoral Student: Paulo Felisberto
Advisor: Sérgio de Jesus
Initiated: June 2000
Expected conclusion: 2003
Current status: on going
Grant: PRODEP
Documents produced in 2002:

Research Area: Array Signal Processing in Underwater Acoustics
Title: Array processing for ocean acoustic tomography on range-dependent environments
Student: Cristiano Soares
Advisor: Sergio M. Jesus
Initiated: September 2001
Expected conclusion: 2004
Current status: on going
Grant: FCT fellowship under project ATOMS
Documents produced in 2002: [46] , [87]

Research Area: Signal Processing
Title: Oceanic parameter estimation using multi-dimensional representations of acoustic signals
Student: Nelson Martins
Advisor: Sergio M. Jesus
Date: September 2002
Expected conclusion: 2005
Current status: on going
Grant: FCT fellowship
Documents produced in 2002: [83] , [88]

Research Area: Underwater Acoustic Communications
Title: Environmentally robust methods for underwater acoustic communications
Student: Antonio Joao Silva
Advisor: Sergio M. Jesus
Date: September 2001
Expected conclusion: 2005
Current status: on going
Grant: Teaching Assistant
Documents produced in 2002: [81] , [82]

Research Area: Marine Robotics
Title: Identification and Control of Surface Craft
Doctoral Student: Fei Chun Ma
Advisor: António Pascoal
Initiated: 2001
Expected Conclusion: 2004
Current Status: research in progress
Grant: FCT Graduate Scholarship
Documents produced in 2002:

Research Area: Navigation
Title: Terrain Based Navigation of Autonomous Underwater Vehicles (AUVs)
Doctoral Student: Francisco Curado Teixeira
Advisor: António Pascoal / Hipólito Monteiro (Instituto Geológico e Mineiro – IGM)
Initiated: 2001
Expected Conclusion: 2004
Current Status: research in progress
Grant: FCT Graduate Scholarship
Documents produced in 2002:

Research Area: Control Theory
Title: Robust Multiple-Model Adaptive Control (MMAC) Based on μ -Synthesis
Doctoral Student: Sajjad Fekri Asl
Advisor: António Pascoal / Michael Athans
Initiated: 2002
Expected Conclusion: 2005
Current Status: research in progress
Grant: FCT Graduate Scholarship
Documents produced in 2002: [69]

Research Area: Control Theory
Title: Path Following Control of Autonomous Vehicles
Doctoral Student: Reza Ghabcheloo
Advisor: António Pascoal / Carlos Silvestre
Initiated: 2002
Expected Conclusion: 2006
Current Status: research in progress
Grant: FCT Graduate Scholarship
Documents produced in 2002:

Research Area: Guidance and Control of Dynamic Systems
Title: Sensor-Based Guidance and Control of Robotic Vehicles
Doctoral Student: Rita Cunha
Advisor: Carlos Silvestre
Initiated: 2001
Expected Conclusion: 2005
Current Status: research in progress
Grant: FCT Graduate Scholarship
Documents produced in 2002: [64] , [144] , [148] , [156]

Research Area: Aeroacoustics
Title: Acoustics of curved ducts and vertical flows
Doctoral Student: Pedro G.T.A. Serrão
Advisor: L.M.B.C. Campos
Initiated: 1999
Conclusion: 2004
Current Status: writing of the thesis
Grant:
Documents Produced in 2002:

Research Area: Aeroacoustics
Title: Acoustics of nozzles with non-uniform impedance
Doctoral Student: João M. S. Oliveira
Advisor: L.M.B.C. Campos
Initiated: 1999
Conclusion: 2004
Current Status: obtaining final results and writing of the thesis
Grant:
Documents Produced in 2002:

Research Area: FLIGHT MECHANICS
Title: Aircraft Separation in Air Traffic Management
Doctoral Student: J. Marques
Advisor: L. M. B. C. Campos
Initiated: 2000
Expected conclusion: 2004
Current Status: in progress
Grant:
Documents produced in 2002:

MASTER THESES (27)

Research Area: Artificial Intelligence
Title: Emotion-based Agents in Social Contexts
Master Student: Márcia Maças
Advisor: Luis Manuel Marques Custódio
Initiated: 1999
Expected conclusion: 2003
Current status: Finished (waiting final discussion)
Grant:
Documents produced in 2002:

Research Area: Artificial Intelligence
Title: Learning for Emotion-based Agents
Master Student: Pedro Vale
Advisor: Luis Manuel Marques Custódio
Initiated: 1999
Expected conclusion: 2003
Current status: Finished (waiting final discussion)
Grant:
Documents produced in 2002: [89]

Research Area: Artificial Intelligence
Title: Manufacturing Systems Control using Societies of Agents
Master Student: Ivone Fernandes
Advisor: Luis Manuel Marques Custódio
Initiated: 1999
Expected conclusion: 2003
Current status: On-going
Grant:
Documents produced in 2002:

Research Area: Artificial Intelligence
Title: Supply-Chains : an Multi-agent System Approach
Master Student: Rui Carvalho
Advisor: Luis Manuel Marques Custódio
Initiated: 2001
Expected conclusion: 2003
Current status: On-going
Grant:
Documents produced in 2002:

Research Area: Artificial Intelligence
Title: Emotion-based Agent Architectures
Master Student: Bruno Damas
Advisor: Luis Manuel Marques Custódio
Initiated: 2001
Expected conclusion: 2003
Current status: On-going
Grant:
Documents produced in 2002:

Research Area: Artificial Intelligence
Title: Agents with Personality : Applications to the Robotic Soccer Case-Study
Master Student: Carla Penedo
Advisor: Luis Manuel Marques Custódio
Initiated: 2002
Expected conclusion: 2003
Current status: On-going
Grant:
Documents produced in 2002:

Research Area: Artificial Intelligence
Title: Development of Coach Agent for a Robotic Soccer Team
Master Student: João Pavão
Advisor: Luis Manuel Marques Custódio
Initiated: 2002
Expected conclusion: 2003
Current status: On-going
Grant:
Documents produced in 2002:

Research Area: Artificial Intelligence
Title: Learning on a Multi-Agent Soccer Robotic System
Master Student: Pedro Nunes
Advisor: Luis Manuel Marques Custódio
Initiated: 2002
Expected conclusion: 2003
Current status: On-going
Grant:
Documents produced in 2002:

Research Area: Intelligent Control
Title:
Master Student: Hugo Furtado
Advisor: Pedro M. U. A. Lima
Initiated: 2001
Expected conclusion: 2003
Current Status: On-going
Grant:
Documents produced in 2001:

Research Area: Biomedical Engineering
Title: Procura Tabu Evolutivo no Jobshop
Master Student: João Paulo Caldeira
Advisor: Agostinho Rosa
Initiated: 1997
Expected Conclusion: 2003
Current Status: to be discussed
Grant:
Documents produced in 2002:

Research Area: Evolutionary Systems - BioChemistry

Title:

Master Student: Nelson Pereira

Advisor: Agostinho Rosa

Initiated: 2000

Expected Conclusion: 2003

Current Status: on-going

Grant: FCT

Documents produced in 2002:

Research Area: Evolutionary Systems

Title: Processamento de imagens em microscopio confocal

Master Student: Alexandre Calapez

Advisor: Agostinho Cláudio da Rosa

Initiated: 2002

Expected Conclusion: 2004

Current Status: started

Grant:

Documents produced in 2002:

Research Area: Evolutionary Systems - Programming

Title: Visuak Programming Language

Master Student: Ivo Bhatt

Advisor: Agostinho Rosa

Initiated: 2002

Expected Conclusion: 2004

Current Status: on-going

Grant:

Documents produced in 2002:

Research Area: Evolutionary Systems - BioInformatics

Title: Model Based Functional Genomics

Master Student: Marcio Mourao

Advisor: Agostinho Rosa

Initiated: 2002

Expected Conclusion: 2004

Current Status: on-going

Grant:

Documents produced in 2002:

Research Area: Cooperative SLAM

Title: not yet available

Master Student: Zlatan Tatarov

Advisor: Maria Isabel Ribeiro

Initiated: 2002

Expected conclusion: 2004

Current Status: On-going

Grant:

Documents produced in 2001:

Research Area: Design of Organizations

Title: Reorganização Dinâmica de Processos Face a Situações de Crise: Aplicação em Exemplos Robóticos e Empresariais Simplificados

Master Student: Sérgio Guerreiro

Advisor: João Sequeira

Initiated: 2001

Expected conclusion: May 2003

Current Status: Concluded in 2002, waiting for discussion

Grant:

Documents produced in 2001: [142]

Research Area: Applied Robotics

Title: Inspeção e Manutenção Robótica em Linhas de Transporte de Energia Eléctrica de Alta Tensão

Master Student: José Inácio Rocha

Advisor: João Sequeira

Initiated: 2001

Expected conclusion: December 2003

Current Status: On-going

Grant:

Documents produced in 2001:

Research Area: Queuing Networks

Title: Not yet available

Master Student: Tiago Barroso

Advisor: Carlos Bispo

Initiated: 2002

Expected conclusion: 2003

Current status: on-going

Grant: ISR programmatic funding

Documents produced in 2002:

Research Area: Signal Processing, Communications

Title: Not yet available

Master Student: Tiago Patrão

Advisor: Victor Barroso

Initiated: 2002

Expected conclusion: 2003

Current status: on-going

Grant: POSI/38775/CPS/2001 research assistant

Documents produced in 2002: [98] , [190] , [193]

Research Area: Signal Processing, Communications

Title: Not yet available

Master Student: Paulo Lopes

Advisor: Victor Barroso

Initiated: 2000

Expected conclusion: 2003

Current status:

Grant: POSI/38775/CPS/2001 research assistant

Documents produced in 2002: [99] , [191]

Research Area: Video processing
Title: Not yet available
Master Student: Rui F. C. Guerreiro
Advisor: Pedro M. Q. Aguiar
Initiated: 2002
Expected conclusion: 2003
Current status:
Grant: POSI/SRI/41561/2001 research assistant
Documents produced in 2002: [108] , [110] , [194]

Research Area: Urban Traffic Control
Title: Influence of private traffic over the average speed of public transport in Lisbon
Master Student: Manuel Augusto Vieira
Advisor: Carlos Bispo
Initiated: 2001
Expected conclusion: 2003
Current status: manuscript reviewing
Grant:
Documents produced in 2002: First draft of thesis

Research Area: Real Time Systems
Title: Distributed Architectures for Real-Time Control
Master Student: João Alves
Advisor: Carlos Silvestre
Initiated: October 2002
Conclusion: 2003
Current Status: research in progress
Grant: FCT / MAROV project
Documents produced in 2002:

Research Area: Image Processing and Control
Title: Marine Craft Control using Image and 3D Shape Matching
Master Student: Wong Chio Teng
Advisor: António Pascoal
Initiated:
Conclusion:
Current Status: Thesis submitted
Grant:
Documents produced in 2002:

Research Area: Discrete Event Systems, Mission Control
Title: Mission Control for Autonomous Vehicles
Master Student: Rodolfo Oliveira
Advisor: Carlos Silvestre
Initiated: December 2001
Conclusion: April 2003
Current Status: Thesis submitted
Grant: ONI MSc Scholarship
Documents produced in 2002:

Research Area: Tracking Systems
Title: Prediction and Tracking of Moving Targets in 2D
Master Student: Pedro Alves
Advisor: Carlos Silvestre
Initiated: June 2001
Conclusion: April 2003
Current Status: submitted
Grant: FCT Scholarship
Documents produced in 2002:

Research Area: Computer Vision
Title: Optimal methods for Image Matching
Master Student: Nuno Pinho da Silva
Advisor: João Paulo Costeira
Initiated: 2002
Conclusion: 2004
Current Status: On-going
Grant:
Documents produced in 2002:

3.4 ADVANCED TRAINING

3.4.1 COURSES

Agostinho Rosa - Signal processing in Clinical Neurophysiology, Pos-grad course in Medicine, FML "Biomedical Engineering - BioMed 02"

António Pascoal - Nonlinear Control Systems - a one semester doctoral level course, 2002

Carlos Silvestre - Introduction to the Synthesis of Feedback Control Systems Using Linear Matrix Inequalities - a three weeks open course , 2002

João Sentieiro - Nonlinear Programming - Doctoral Program course- 1st Semester 2002.

Luis Custódio - Artificial Intelligence - Masters Program course- 1st Semester 2002

Luis Custódio - Modelling and Control of Automated Manufacturing Systems - Masters Program course- 1st Semester 2002

Michael Athans/Paulo Oliveira - Dynamic Stochastic Estimation, Filtering, Prediction and Smoothing - Doctoral Program course - 1st Semester 2002.

Michael Athans/Carlos Silvestre - Design of Robust Multivariable Feedback Control Systems - Doctoral Program course - 2nd Semester 2002.

Pedro Lima - Discrete Event Dynamic Systems - Doctoral Program course- 1st Semester 2002

3.4.2 SEMINARS

During 2002 the following Seminars were organized at ISR:

Mos Kaveh - MODELING AND EXPLOITING SPACE-TIME CHANNELS FOR WIRELESS COMMUNICATIONS

Department of Electrical and Computer Engineering - University of Minnesota
February 14, 17h 30m, Anf. EA3

Ognyan B. Manolov - AUTONOMOUS MOBILE ROBOTS - PERCEPTION, BEHAVIOUR AND CONTROL

Institute of Control and Systems Research - Bulgarian Academy of Sciences
April 4, ISR Meeting room

Takeo Kanade - RECENT ADVANCES IN COMPUTER VISION

Robotics Institute - Carnegie Mellon University
April 8 , Civil Eng Building room VA03

Dejan Milutinovic - APPLICATION OF NONLINEAR ESTIMATION THEORY IN T-CELL RECEPTOR TRIGGERING MODEL IDENTIFICATION

ISR-IST
April 17, ISR Meeting room

Rita Cunha - MODELING AND CONTROL OF AN AUTONOMOUS ROBOTIC HELICOPTER

ISR-IST

April 19, ISR Meeting room

Paulo Jorge Oliveira - PERIODIC ESTIMATOR SYNTHESIS USING LMIS: AN APPLICATION TO THE DESIGN OF A NAVIGATION SYSTEM FOR THE DELFIM CATAMARAN

ISR-IST

May 3, ISR Meeting room

Sebastien Bausson - DRIFTING SENSORS IN CLASSIC OCEAN ACOUSTIC TOMOGRAPHY

Laboratoire des Images et des Signaux - ST MARTIN D'HERES, FRANCE

May 10, ISR Meeting room

Bruno Damas - A MODIFIED POTENTIAL FIELDS METHOD FOR ROBOT NAVIGATION APPLIED TO DRIBBLING IN ROBOTIC SOCCER

ISR/IST

June 12, ISR Meeting room

Shahriar Negahdaripour - RECENT DEVELOPMENTS IN UNDERWATER VISION PROJECTS AT UVIL UNDERWATER VISION AND IMAGING LABORATORY (UVIL)

Department of Electrical and Computer Engineering - University of Miami, Coral Gables FL, USA

July 19, ISR Meeting room

Anna Helena Reali Costa - ROBÓTICA MÓVEL AUTÔNOMA - PESQUISA EM DESENVOLVIMENTO: LTI-USP / IEC-ITA

Laboratório de Técnicas Inteligentes - Universidade de São Paulo

and

Carlos H. C. Ribeiro

Divisão de Ciência da Computação - Instituto Tecnológico de Aeronáutica

July 22, ISR Meeting room

Xiang-Gen Xia - ORTHOGONAL SPACE-TIME BLOCK CODES, COMPOSITIONS OF QUADRATIC FORMS, AND ORTHOGONAL DESIGNS

Dept of Electrical and Computer Engineering - University of Delaware, Newark, USA

July 27, ISR Meeting room

Milica Stojanovic - HIGH SPEED WIRELESS UNDERWATER COMMUNICATIONS

Massachusetts Institute of Technology

July 29, ISR Meeting room

John H. Cozzens - AN OVERVIEW OF NSF AND OUR MISSION

NSF Program Director, Signal Processing Systems, Division of Computer-Communication

December 20, Room EA1, Torre Norte (DEEC)

Note: Some ISR Laboratories, such as Vislab , DSOR lab and ESBE lab organize internal weekly meeting

3.4.3 READING GROUPS

Reading group on Computer Vision (VISLAB)

Reading group on Evolutionary Computation and Biomedical Signal Processing and Classification (ESBE)

3.4.4 VISITS ABROAD

Pedro Lima, participated in *RoboCup 2002*, in Fukuoka, 2-10 August, as co-chair of the *RoboCup 2002 Symposium* and as proponent of the *RoboCup 2004* – Portugal candidacy.

Alberto Vale – Participation in the “Summer School on Simultaneous Localization and Mapping, “ Center for Autonomous Systems, KTH, Stockholm, Sweden, August 5-9, 2002

Francisco Teixeira – Participation in the “Summer School on Simultaneous Localization and Mapping, “ Center for Autonomous Systems, KTH, Stockholm, Sweden, August 5-9, 2002

Lionel Lapierre - Participation in the “Visual Servoing Summer School,” Benicassim, Spain, 16-20/09/2002

3.4.5 SUPERVISION OF STUDENTS ENROLLED IN FOREIGN UNIVERSITIES

Cláudia Deccó, Ph.D. Student from University of São Paulo , Brazil, 2002.

Ernesto Soares, Ph.D. Student from Duke University, USA , 2002.

Lenildo Silva, Ph.D. Student from University Federal do Rio de Janeiro, Brazil, 2002.

Raquel Vassalo, Ph.D. Student from University Federal do Espírito Santo, Brazil, 2002.

Roberta Vieira , Ph.D. Student from University of Federal de Pernambuco, Brazil , 2002.

Hans Lausen, Undergrad Student from Aalborg University, Denmark , 2002.

Michael Nielsen , Undergrad Student from Aalborg University, Denmark , 2002.

Jakob Nielsen , Undergrad Student from Aalborg University, Denmark , 2002.

Thomas Krause , Undergrad Student from Aalborg University, Denmark , 2002.

3.5 CONGRESS, MEETINGS AND PRESENTATIONS

This section includes invited talks, conferences attended and conferences where papers were presented, during 2002, by ISR-Lisbon researchers.

3.5.1 INVITED TALKS

António M. Pascoal - "Control of AUVs, ROVs, and Autonomous Surface Craft, " a 4 hour lecture given at the 1st Lerici International Winter School on Marine Technologies, Lerici, Italy, January 7-11, 2002 .

Fernando Lau - "Realidade Actual e Evolução Prevista para os Centros de Pesquisa e Desenvolvimento em Portugal ", 1^{as} Jornadas de Engenharia Aeronáutica , Ordem dos Engenheiros, February 28 , 2002.

Agostinho Rosa - "Algoritmos Genéticos" Semana de Informática do IST, March 2002.

Agostinho Rosa - "Algoritmos Genéticos e Vida Artificial" , CVRM, March 2002.

Luis Custódio - "RoboCup 2004 – Um Desafio para a Inteligência Artificial e a Robótica", Semana Informática do IST, 14 March 2002.

Pedro Lima - "Projectos SocRob e Rescue - Robótica Cooperativa e Sistemas com Múltiplos Agentes", Semana Informática do IST, 14 March 2002.

António M. Pascoal - "Robótica Marinha: Desafios Científicos e Tecnológicos," I Jornadas de Engenharia Electrotécnica: "Novos Desafios", Escola Superior de Tecnologia de Tomar, April 9, 2002.

M. Isabel Ribeiro - "Mobile Robotics: Past, Present and Future" I Jornadas de Engenharia Electrotécnica - Novos Desafios, Instituto Politécnico de Tomar, April 2002.

Pedro Lima - "Path Planning and Navigation", RoboCup Camp 2002, Paderborn, Germany, 8-12 April 2002 .

Pedro Lima - "Redes de Petri e Modelos de Tarefas Robóticas", Instituto de Sistemas e Robótica, Coimbra, April 2002 .

Fernando Lau - "Investigação em Aeroacústica", Semana Aeroespacial no IST, May 20-24, 2002.

Paulo Gil - "Ondas Magneto-hidrodinâmicas na Heliosfera", Semana Aeroespacial no IST, May 20-24, 2002.

Pedro Lima - "SocRob – Society of Robots / Soccer Robots, An Approach to Multi-Robot System Design", GRASP Lab Seminar, University of Pennsylvania, 16 May 2002 .

Sérgio M. Jesus - "Blind Ocean Acoustic Tomography: experimental results on the INTIFANTE'00 data set" Europ.Conference in Underwater Acoustics 2002, pp. 9-18, Gdansk, Poland, June 2002 (plenary invited talk).

António M. Pascoal - "Bridging the Gap Between Theory and Practice," Plenary Talk, 5th Portuguese Conference on Automatic Control, Aveiro, Portugal, September 5-7, 2002.

João Sequeira - "The Project COOPERA: Cooperation Among Autonomous Robots - A Geometric Perspective on Robot Cooperation", Universidade de Coimbra, September, 2002.

Agostinho Rosa - "Computação Evolutiva" 1 Encontro de Engenharia Biomédica, October 2002.

Agostinho Rosa - "New Robotics, evolution and embodied cognition", IISREEC, Lisboa, November 2002.

Sérgio M. Jesus - "Model-based inverse problems in underwater acoustics", Workshop on Inverse Obstacle Problems (WIOP'02), Lisboa, Portugal, November 2002 (invited).

Sérgio M. Jesus - "Blind Ocean Acoustic Tomography and TOMPACO", Workshop on "Ocean Acoustic Tomography: results and perspectives", ENEA, Lerici (Italy), November 2002 (invited).

Agostinho Rosa - "Model based signal processing", AFIP, Sao Paulo, December 2002.

Agostinho Rosa - "Cyclic Alternating Pattern in Sleep", AFIP, Sao Paulo, December 2002.

Sérgio M. Jesus - "Virtual Time - Reversal in Underwater Communications: Results on the INTIFANTE'00 Sea Trial", Forum Acusticum, Sevilla, Spain, 2002 (invited).

3.5.2 PARTICIPATIONS

During 2002 ISR-Lisbon researchers participated in the following International conferences, workshops and meetings:

15th IFAC World Congress, Barcelona, Spain, July 2002

CONTROLO 2002 Conference, Aveiro, Portugal, September 2002.

IEEE Conference on Decision and Control, USA, December 2002.

IEEE International Conference on Acoustics, Speech and Signal Processing, ICASSP 2002, Orlando, USA, May 2002

IEEE International Symposium on Information Theory, ISIT2002, Lausanne, Suíça, July 2002

International Telecommunications Symposium, ITS2002, Natal, Brazil, September 8-12, 2002

IEEE International Conference on Image Processing, ICIP'02, Rochester, USA, September 2002

IEEE International Conference on Oceanic Engineering, Oceans '02, Biloxi, Mississippi, USA, October 29-31, 2002

IEEE International Workshop on Multimedia Signal Processing, MMSP'02, St. Thomas, USA, December, 2002

EURON annual meeting, Pisa, Italy, January 2002.

10th IEEE Mediterranean Conference on Control and Automation, MED2002, Lisbon, Portugal, June 2002.

2^o Festival Nacional de Robótica, Robótica 2002, Aveiro, Portugal, April 2002.

EURON Summer School on SLAM -Simultaneous Localization and Map Building, KTH, Stokolm, Sweden, July 2002.

The Mobile Robotics Laboratory presented some of its Lego robots in the Student Forum, a national event that took place in Lisbon, December 2002.

RoboCup 2002 Symposium, Fukuoka, Japan, 2002

Hybrid Systems : Computation and Control, 5th International , Workshop, Stanford, California, 2002

IEEE International Conference on Robotics and Automation, Washington D.C. , 2002

7th International Conference on Simulation of Adaptive Behaviour, Edinburg, UK, 2002

ACE2002, EMCRS2002 , Viana, Austria, 2002

International Conference on Artificial Intelligence and Applications, Malaga, Spain, 2002

Forum Acusticum, Sevilla, Spain, September 2002

ECUA '02, Gdansk, Poland, June 2002

ISIT2002 , Lausanne, Suíça , July 2002

2nd International Workshop on Articulated Motion and Deformable Models, Maiorca, Spain , November 2002

2nd Workshop on Pattern Recognition in Information Systems , Alicante, Spain , April 2002

2nd Workshop on Biological Motivated Computer Vision, BMCV, Tuebingen, Germany, November 2002

3rd International Workshop on Robot Motion and Control, Bukowy Dworek, Poland, November 2002

International Conference on Intelligent Robots and Systems, IROS 2002 , Lausanne , Switzerland , October 2002.

British Machine Vision Conference , BMVC2002, Cardiff , UK , September, 2002

International Conference on Pattern Recognition, ICPR, Quebec , Canada , August 2002

European Conference on Computer Vision, ECCV, Copenhagen , Denmark , June 2002

25th European Conference on Visual Perception, Glasgow, August 2002

Biologically Motivated Computer Vision Workshop, Tuebingen, November 2002

23rd Congress of the International Council of Aeronautical Sciences, Toronto, Canada , 2002

3.6 SERVICE ACTIVITIES

This section is dedicated to service activities developed, during 2002, by ISR-Lisbon researchers as members of the national and international scientific community.

3.6.1 EDITORIAL BOARDS

L.M.B.C. Campos – Progress Aerospace Sciences

Pedro Lima - member of the Editorial Board of the Portuguese *Robótica* magazine.

Victor Barroso - associate editor, IEEE Signal Processing Letters

3.6.2 ADVISORY BOARDS

Agostinho Rosa – member of the IASTED TC – Biomedical Engineering

Agostinho Rosa – member of the IFAC TC – Optimal Control

João Sentieiro – member of the evaluation board of the Program “Ph.Ds and M.Sc.s for the Industry” of the Agency for Innovation (AdI), Ministry of Science and Higher Education, 2002.

João Sentieiro - member of the European Space Agency (ESA) Advisory Group on Robotics and Automation.

Jorge S. Marques - President of the Portuguese Association for Pattern Recognition (APRP) and member of IAPR Governing Board.

José Santos-Victor - member of the Aurora Board of Participants of the European Space Agency (ESA).

Pedro Lima – member of the Executive Committee of the RoboCup Federation.

Victor Barroso - representative of the IEEE Signal Processing Society in the Technical Advisor Board Wireless Periodicals Committee

Victor Barroso - representative of the IEEE Signal Processing Society in the steering committee of the IEEE Transactions on Mobile Computing

Victor Barroso - member of the Sensor Array and Multichannel (SAM) Technical Committee of the IEEE Signal Processing Society.

3.6.3 PROGRAMME AND TECHNICAL COMMITTEES

Agostinho Rosa - Member of the Programme Committee of the ACM SAC'02 - Artificial Intelligence and Computational Logic Track – Madrid - Spain - March 2002.

Jorge S. Marques - member of the Technical Committee of the 2nd Workshop on Pattern Recognition in Information Systems, IAPR, Alicante, Spain, April, 2002.

M. Isabel Ribeiro – Member of the Program Committee of the 2nd. National Festival of Robotics– Robotica 2002, Aveiro, Portugal, April 2002.

José Santos-Victor – Member of the Programme Committee of the “European Conference on Computer Vision ECCV”, Copenhagen, Denmark, May 2002.

Luis Custódio – member of the Program Committee of the “Conferência Científica e Tecnológica em Engenharia”, ISEL, Lisbon, May 2002

Luis Custódio – Member of the Organizing Committee, in charge of the Scientific Meeting, of the 3rd National Festival of Robotics, Robótica 2003, Lisbon, Portugal, May 2003.

M. Isabel Ribeiro – Member of the Organizing Committee, in charge of the Scientific Meeting, of the 3rd National Festival of Robotics, Robótica 2003, Lisbon, Portugal, May 2003.

Pedro Lima – Member of the Organizing Committee, in charge of the Scientific Meeting, of the 3rd National Festival of Robotics, Robótica 2003, Lisbon, Portugal, May 2003.

Pedro Lima – member of the Organizing Committee of the 11th International Conference on Advanced Robotics, ICAR 2003, Coimbra, June-July 2003

Agostinho Rosa - Member of the Programme Committee of the MED2002 – July 2002 Lisboa, Portugal

António Pascoal - Program Vice-Chair of MED2002 - IEEE 10th Mediterranean Conference on Control and Automation, MED2002, Lisbon, Portugal, July 2002.

Luis Custódio – members of the Program Committee of the IEEE Mediterranean Conference on Robotics and Automation, MED'2002, Lisboa, July 2002

João Sentieiro – General Chair of the IEEE 10th Mediterranean Conference on Control and Automation (MED2002) , July 2002, Lisbon, Portugal.

Jorge S. Marques - member of the Technical Committee of the 12th Portuguese Conference on Pattern Recognition, RecPad, Aveiro, July 2002.

Michael Athans – Program Chair of the 10th IEEE Mediterranean Conference on Control and Automation, Lisbon, July 9-12, 2002.

M. Isabel Ribeiro - General Chair and Chair of the International Program Committee of the 5th IFAC Symposium on Intelligent Vehicles, IAV2004, Lisbon, 5-7 July 2004.

M. Isabel Ribeiro – Member of the Program Committee and of the Organizing Committee of MED2002 - IEEE 10th Mediterranean Conference on Control and Automation, MED2002, Lisbon, Portugal, July 2002.

Pedro Lima – member of the Organizing Committee of the IEEE Mediterranean Conference on Robotics and Automation, MED'2002, Lisboa, July 2002

Pedro Lima – members of the Program Committee of the IEEE Mediterranean Conference on Robotics and Automation, MED'2002, Lisboa, July 2002

Sérgio M. Jesus - Member of the Programme Committee of ECUA'02, Gdansk, Poland, July 2002

Victor Barroso - member of the International Program Committee of the IEEE 10th Mediterranean Conference on Control and Automation - MED2002- Lisboa, Portugal, July 2002.

José Santos-Victor – Member of the Programme Committee of the “International Conference on Pattern Recognition”, CANADA, August 2002.

M. Isabel Ribeiro – Chair of the European Summer School on Cooperative Robotics, Instituto Superior Técnico, Lisbon, Portugal, September 2002.

M. Isabel Ribeiro – member of the Program Committee of the 5th Portuguese Conference on Automatic Control, CONTROLO'2002, Aveiro, Portugal, September 2002.

M. Isabel Ribeiro – Member of the Program Committee of the IROS Workshop on Cooperative Robotics, Lausanne, Switzerland, October 2002.

Agostinho Rosa - Member of the Programme Committee of the ICEIS 02 – Setúbal

Agostinho Rosa - Member of the Programme Committee of the ICANN 02 – Artificial Neural Networks

Agostinho Rosa - Member of the Programme Committee of the IASTED - Applied Simulation and Modelling - ASM 2002, Crete Greece

Agostinho Rosa - Member of the Programme Committee of the WMSF - IASTED – Simulation and Modeling 2002, Marina Del Rey, CA, EUA

Agostinho Rosa - Member of the Programme Committee of the AI 2002 – Applied Informatics – Vienna – Austria

Agostinho Rosa - Member of the Programme Committee of the CA 2002 – Control Applications – Cancun, Mexico.

Agostinho Rosa - Member of the Programme Committee of the ASC 2002 – Artificial Intelligence and Soft Computing – Banff, Alberta, Canada.

António Pascoal - Member, International Program Committee, 5th Portuguese Conference on Automatic Control, Aveiro, Portugal.

António Pascoal - Member, International Federation of Automatic Control Technical Committee on Marine Applications.

António Pascoal - Member, International Federation of Automatic Control Technical Committee on Intelligent Autonomous Vehicles.

António Pascoal – Member, Workgroup on *Research Vessels* of the Intersectorial Oceanographic Mission / Ministry of Science and Technology, Portugal. Objective of the Workgroup: to assess the state of the scientific fleet and to define guidelines for its expansion and efficient utilization by the scientific community at large.

António Pascoal – Member, Workgroup on *Deep Sea Research* of the Intersectorial Oceanographic Mission / FCT, Portugal. Objective of the Workgroup: to foster the development of deep sea marine science and technologies.

António Pascoal – Portuguese Representative to EurOcean: an Internet Portal For Marine Science and Technology in Europe, FCT, Lisbon, Portugal.

Carlos Pinto-Ferreira – member of the Organizing Committee of the ACE2002, EMCSR'2002, Vienna, Austria, 2002.

M. Isabel Ribeiro – member of the IFAC Technical Committee on Intelligent Autonomous Vehicles.

Sérgio M. Jesus - Member of the Programme Committee of International Conference on Inverse Problems, Fethey, (Turkey).

Rodrigo Ventura – member of the Organizing Committee of the ACE2002, EMCSR'2002, Vienna, Austria, 2002.

Pedro Lima – member of the International Program Committee of the 2^d International Joint Conference on Autonomous Agents and Multi-Agent Systems 2003, AAMAS 2003, Melbourne, Australia, July 2003

M. Isabel Ribeiro – Member of the Program Committee of the 12^o Encontro Português de Computação Gráfica, October 2003, Porto, Portugal.

M. Isabel Ribeiro – Member of the International Program Committee of the 11th IEEE International Conference on Advanced Robotics, ICAR 2003, Coimbra, Portugal, July 2003.

3.6.4 CHAIRPERSON

Agostinho Rosa - ACM SAC'02 - Artificial Intelligence and Computational Logic Track – Madrid - Spain - March 2002.

M. Isabel Ribeiro – Chair of a session on Mobile Robotics on the Scientific Meeting associated with the 2nd National Festival of Robotics– Robótica 2002, Aveiro, Portugal, April 2002.

Luis Custódio – session chair of the “Conferência Científica e Tecnológica em Engenharia”, ISEL, Lisbon, May 2002

Victor Barroso - Poster Session Chair, IEEE International Conference on Acoustics, Speech and Signal Processing - ICASSP02, Orlando, Florida, EUA, May 2002

Pedro Lima – co-chair of the RoboCup 2002 Symposium, Fukuoka, Japan, June 2002

M. Isabel Ribeiro – Chair of a session on Mobile Robotics on the IEEE 10th Mediterranean Conference on Control and Automation, MED2002, July 2002.

Sérgio M. Jesus - Chair of ECUA'02, Gdansk, Poland, July 2002

João Sentieiro – Chair of the Session “Planetary Robotics: Mobility and Hardware” of the 7th ESA Workshop on Advanced Space Technologies for Robotics and Automation, ASTRA 2002, Noordwijk, Netherlands, November 19-21, 2002.

António Pascoal - 5th Portuguese Conference on Automatic Control , Aveiro, Portugal

António Pascoal – 15th IFAC World Congress, Barcelona, Spain.

Victor Barroso - General – Chair of the Portuguese IEEE Signal Processing Chapter

3.6.5 REVIEWERS

Agostinho Rosa - IEEE Transaction of Circuits and Systems for Video Technology.

Agostinho Rosa - IEEE Transaction of Biomedical Engineering

Agostinho Rosa - Clinical Neurophysiology

Agostinho Rosa - International Journal of Imaging and Graphics

António Pascoal - Journal of Marine Engineering and Technology, Proceedings of the Institute of Marine Engineering, Science and Technology

António Pascoal - International Journal of Nonlinear and Robust Control

António Pascoal - Automática

António Pascoal - IEEE Conference on Decision and Control, 2002.

António Pascoal - 5th PORTUGUESE CONFERENCE ON AUTOMATIC CONTROL, Aveiro, Portugal

António Pascoal - IFAC Workshop, GCUV'2003

António Pascoal - 15th IFAC World Congress, Barcelona, Spain.

Carlos Bispo - IEEE 10th Mediterranean Conference on Control and Automation – MED2002 – Lisboa, Portugal, July 2002

Carlos Silvestre - International Journal of Nonlinear and Robust Control

Carlos Silvestre - IEEE 10th Mediterranean Conference on Control (MED2002) , Lisbon, Portugal.

Francisco Garcia - IEEE Transactions on Signal Processing

João P. Gomes - IEEE Transactions on Communications

João P. Gomes - IEEE Signal Processing Letters

João P. Gomes - IEEE 10th Mediterranean Conference on Control and Automation - MED2002- Lisboa, Portugal, July 2002

João Sequeira - MED2002 – 10th Mediterranean Conference on Control and Automation, Lisbon, Portugal, July 2002

João Xavier - IEEE Transactions on Signal Processing

João Xavier - IEEE International Symposium on Information Theory - ISIT02, Lausanne, Suíça, July 2002

M. Isabel Ribeiro - Machine Vision and Applications.

M. Isabel Ribeiro - IROS Workshop on Cooperative Robotics, Lausanne, Switzerland, October 2002

M. Isabel Ribeiro - ROBÓTICA 2002 – Festival Nacional de Robótica, Aveiro, Portugal, April 2002

M. Isabel Ribeiro - MED2002 – 10th Mediterranean Conference on Control and Automation, Lisbon, Portugal, July 2002

M. Isabel Ribeiro - IFAC – 14th IFAC World Congress (area of Intelligent Autonomous Vehicles) Barcelona, Spain, July 2002.

M. Isabel Ribeiro - CONTROLO – Conferência Portuguesa de Controlo Automático, Aveiro, Portugal, September 2002.

Miloud Frikel - IEEE Transactions on Circuits & Systems II: Analog and Digital Signal Processing

Miloud Frikel - IEEE Signal Processing Letters

Miloud Frikel - IEEE Communications Letters

Paulo M. Oliveira - IEEE Transactions on Signal Processing

Paulo M. Oliveira - IEEE Signal Processing Letters

Pedro Lima, Luis Custódio and Sandra Gadanho – 2nd International Joint Conference on Autonomous Agents and Multi-Agent Systems 2003, AAMAS 2003

Pedro Lima – Elsevier Robotics and Autonomous Systems

Pedro Lima – IEEE Transactions on Systems, Man and Cybernetics

Pedro Lima – IEEE Mediterranean Conference on Robotics and Automation, MED'2002

Pedro Lima – RoboCup 2002 Symposium

Pedro Lima – PhD Thesis of Javier Minguez, “Robot Shape, Kinematics and Dynamics in Sensor-Based Motion Planning”, Dept. de Informática e Ingeniería de Sistemas, Centro Politécnico Superior, Universidad de Zaragoza, Spain, July 2002

Pedro M. Q. Aguiar - IEEE International Conference on Image Processing – ICIP'02, Rochester, USA, September 2002

Pedro M. Q. Aguiar - IEEE International Workshop on Multimedia Signal Processing – MMSP'02, St. Thomas, USA, December 2002

Sebastien Bausson - IEEE Signal Processing Letters

Sérgio M. Jesus - Journal of Acoustical Society of America

Sérgio M. Jesus - IEEE Journal of Oceanic Engineering

Sérgio M. Jesus - ICASSP'03

Victor Barroso - IEEE Transactions on Signal Processing

Victor Barroso - IEEE Transactions on Antennas and Propagation

Victor Barroso - IEEE International Conference on Acoustics, Speech and Signal Processing - ICASSP02, Orlando, Florida, EUA, May 2002

Victor Barroso - IEEE International Symposium on Information Theory - ISIT02, Lausanne, Suíça, July 2002

Victor Barroso - IEEE 10th Mediterranean Conference on Control and Automation - MED2002- Lisboa, Portugal, July 2002

3.6.6 OTHER ACTIVITIES

Agostinho Rosa - Evaluation and review expert for EU Information Society and Technology Program – PE - TC

António Pascoal - Project Evaluator, Programma Nazionale di Ricerche in Antartide, Italian Scientific Committee for Antartic Research, Research Proposals for 2003-2004.

António Pascoal - Project Evaluator, Industry and Energy Program / Underwater Navigation and Mapping Project, The Research Council of Norway, Oslo, Norway.

Francisco Garcia - member of the Executive Board of IST's Dept. of Electrical and Computer Engineering

Jorge S. Marques - reviewer of the EPSRC (Engineering and Physical Sciences Research Council, UK) for project funding

Jorge S. Marques - participated on the creation of the IbPRIA conference (Iberian Conference on Pattern Recognition and Image Analysis) to be organized every two years, sponsored by APRP and AERFAI (Portuguese and Spanish Associations for Pattern Recognition). This new conference replaces the Portuguese and Spanish national conferences on Pattern Recognition.

José Santos-Victor – Evaluator of EU- Future Emerging Technologies (FET) R&D Project Proposals.

Luis Braga Campos - Aeronautics Advisory committee, European Union

Luis Braga Campos - Independent Review commission Ariane 5, European Space Agency

Luis Braga Campos - Portugal-ESA Task Force

M. Isabel Ribeiro – responsible, together with Jorge Dias – ISR/Univ.Coimbra, for the proposal of the RoboticsWEBook in the frame of EURON.

Victor Barroso - Vice – President of IST's Scientific Council Executive Board

Victor Barroso - member of the National Science Foundation international evaluation committee of Signal Processing in Communications project proposals, February 2002

3.7 ACADEMIC ACTIVITIES

Here we list the participation, during 2002, of ISR-Lisbon (ECE) researchers in committees for Master and Doctoral Thesis, and other academic related activities.

Agostinho Rosa - Member of the MSc. Thesis Committee of Rui Tavares. "Algoritmos Evolutivos: Variação Condicionada", May 2002.

Agostinho Rosa - Member of the MSc. Thesis Committee of Carlos Fernandes. "Acasalamento não aleatório em algoritmos Evolutivos ", May 2002.

António Pascoal – Member of the PhD Thesis Committee of Segundo Esteban San Román: “Modeling and Control of the Longitudinal Motion of a High Speed Ferry,” Faculty of Physical Sciences, Dept. Arquitectura de Computadores y Automática, Universidad Complutense de Madrid, Madrid, Spain.

António Pascoal – Member of the PhD Thesis Committee of Luís Miguel de Mendonça Rato: “Multimodel-Based Switching Control (in Portuguese),” Instituto Superior Técnico, Lisbon, Portugal.

António Pascoal – Member of the PhD Thesis Committee of Aníbal Castilho Coimbra de Matos: “Optimality Conditions for Dynamic Optimization Problems (in Portuguese), “Faculdade de Engenharia da Universidade do Porto, Porto, Portugal.

António Pascoal – Member of the PhD Thesis Committee of Sérgio Reis Cunha: “Semidefinite Programming in Impulsional Control, with Applications to Aerial Navigation (in Portuguese), “Faculdade de Engenharia da Universidade do Porto, Porto, Portugal.

Carlos Bispo - Master Thesis committee, Jorge Alexandre Correia de Oliveira Vitória, “Sistema de Aninhamento de Chapas para a Indústria Naval com Interface STEP,” IST-UTL, 2002.

João Sentieiro – Doctoral thesis committee of João Lourenço Teixeira Lopes de Sousa Maciel (thesis: Global Matching: Optimal Solution to Correspondence Problems), Instituto Superior Técnico, May 2002.

João Sentieiro – Doctoral thesis committee of António Pedro Aguiar Encarnação (thesis: Nonlinear Path Following Control Systems for Ocean Vehicles), Instituto Superior Técnico 2002

João Sentieiro – Doctoral thesis committee of Pedro Miguel Martins Encarnação (thesis: Nonlinear Path Following Control Systems for Ocean Vehicles), Instituto Superior Técnico 23rd April 2002

João Sentieiro – Doctoral thesis committee of Etienne Grossman, (thesis: Maximum Likelihood 3D Reconstruction from one or more Uncalibrated Views under Geometric Constraints), Instituto Superior Técnico, 2002

João Sentieiro – Doctoral thesis committee of João Manuel de Freitas Xavier, (thesis: Blind Identification of MIMO Channels Based on 2nd Order Statistics and Colored Inputs), Instituto Superior Técnico, 23rd December 2002.

João Sequeira – member of the Ph.D. jury of Paulo Alexandre Trigo Neri Tabuada, that submitted the thesis "Hierarchies and Compositional Abstractions of Hybrid Systems", Instituto Superior Técnico, January, 2002.

João Sequeira – member of the Ph.D. jury of Luís Miguel de Mendonça Rato, that submitted the thesis "Controlo Comutado Baseado em Modelos Múltiplos", Instituto Superior Técnico, September, 2002.

Jorge S. Marques - Doctoral Thesis committee, Luis Filipe Almeida Alexandre, Combining Classifiers. Analysis and Application to Medical Data, University of Porto, 2002.

- Jorge S. Marques** - Doctoral Thesis committee, Paulo Serras Lobato Correia, IST-UTL: Video Analysis for Object Based Coding and Description, IST, Dec. 2002.
- Jorge S. Marques** - Master Thesis committee, Miguel Falcão Moreira de Sousa, Caracterização Semântica de Sinais Acústicos, University of Porto, 2002.
- Jorge S. Marques** - Master Thesis committee, Sandra Vilas Boas Jardim, Análise Automática de Imagens Ecográficas Fetais, IST-UTL, Junho de 2002.
- José Santos-Victor** – Member of the PhD Thesis Committee of Javier Minguez Safra, Universidad de Zaragoza, Spain, December 2002.
- José Santos-Victor** – Member of the PhD Thesis Committee of Vicente Javier Traver, Universidad Jaume I, Castellon, Spain, September 2002.
- José Santos-Victor** – Member of the PhD Thesis Committee of Paulo de Carvalho, Faculdade de Ciências e Tecnologia, University of Coimbra., October 2002.
- José Santos-Victor** – Member of the PhD Thesis Committee of Etienne Grossmann, Instituto Superior Técnico, October 2002.
- José Santos-Victor** – Member of the PhD Thesis Committee of João Maciel, Instituto Superior Técnico, April 2002.
- José Santos-Victor** – Member of the MSc Thesis Committee of João Gomes Mota, Instituto Superior Técnico, May 2002.
- Luis Custódio** - Member of the MSc Thesis Committee of Rui Manuel Amaral de Melo Tavares, “Algoritmos Evolutivos: Variação Condicionada e Controlo de Parâmetros”, Instituto Superior Técnico, UniversidadeTécnica de Lisboa, May 2002
- M. Isabel Ribeiro** – member of the PhD jury of Paulo Jorge Coelho Ramalho Oliveira, that submitted the thesis “Periodic and Non-linear Estimators with Applications to the Navigation of Ocean Vehicles”, Instituto Superior Técnico, July 2002.
- M. Isabel Ribeiro** – member of the M.Sc jury of Rui Cândido Ribeiro Soares, that submitted the thesis “Transporte de um Objecto de grandes dimensões por uma equipa de robots móveis autónomos”, University of Minho, December 2003.
- M. Isabel Ribeiro** – Vice-Director of the Institute for Systems and Robotics / Lisbon pole since February 2002.
- Pedro M. Q. Aguiar** - Doctoral Thesis committee, João Sousa Maciel, "Global Matching: Optimal Solution to Correspondence Problems," IST-UTL, 2002.
- Pedro M. Q. Aguiar** - Doctoral Thesis committee, Etienne Grossmann, "ML 3D Reconstruction from one or more Uncalibrated Views Under Geometric Constraints," IST-UTL, 2002.
- Pedro Lima** - Member of the PhD Thesis Committee of Paulo Alexandre Trigo Neri Tabuada, “Hierarchies and Compositional Abstractions of Hybrid Systems”, Instituto Superior Técnico, UniversidadeTécnica de Lisboa, January 2002
- Pedro Lima** - Member of the PhD Thesis Committee of António Pedro Rodrigues de Aguiar, “Nonlinear Motion Control of Nonholonomic and Underactuated Systems”, Instituto Superior Técnico, UniversidadeTécnica de Lisboa, April 2002
- Pedro Lima** - Member of the PhD Thesis Committee of Pedro Miguel Martins Encarnação, “Nonlinear Path Following Control Systems for Ocean Vehicles”, Instituto Superior Técnico, UniversidadeTécnica de Lisboa, April 2002

Pedro Lima - Member of the MSc Thesis Committee of João Miguel Henriques Pronto, "Turistólogo, o Ciberturista – Um Sistema Pericial para Turismo", Instituto Superior Técnico, UniversidadeTécnica de Lisboa, April 2002

Pedro Lima - Member of the MSc Thesis Committee of João Miguel Murta Pina, "Operação e Controlo de um Forno de Vidro", Instituto Superior Técnico, UniversidadeTécnica de Lisboa, November 2002

Sérgio M. Jesus - member of the Ph.D board of Joao Pedro Gomes (July 2002)

Victor Barroso - Doctoral Thesis committee, João Manuel de Freitas Xavier, "Blind Identification of MIMO Channels Based on 2nd Order Statistics and Colored Inputs – The Riemannian Geometry of Algorithms, Performance Analysis and Bounds over the Quotient Manifold of Identifiable Channel Classes," IST-UTL, 2002.

Victor Barroso - Doctoral Thesis committee, João Pedro C.P. Santos Gomes, "Array Processing Methods for Time-Reversed Underwater Communication Systems," IST-UTL, 2002.

Victor Barroso - Doctoral Thesis committee, Paulo Mónica de Oliveira, "Physical Constraints on the Time-Frequency Plane," IST-UTL, 2002.

3.8 DISTINGUISHED VISITORS

Prof. Andre Quinquis - ENSIETA, Brest, France.

Prof. Anthony Healey – Department of Mechanical Engineering, Naval Postgraduate School, Monterey, California, USA.

Prof. Chiu, Ching-Sang - Naval Postgraduate School, Monterey, USA.

Prof. Ettore Barros, Department of Mechatronics and Mechanical Systems, Escola Politécnica. Universidade de São Paulo, Brasil.

Prof. George Pappas – GRASP Lab, University of Pennsylvania, USA.

Prof. Giovanni Indiveri - German National Center on Information Technologies, Institute for Intelligent Autonomous Systems, GMD-AiS, Germany and Univ. Lecce, Lecce, Italy.

Prof. Helio Morishita, Department of Ocean and Naval Engineering, Escola Politécnica, Universidade de São Paulo, Brasil.

Prof. Javier Lorenzo Navarro - Computer Science and Systems Department , University of Las Palmas, SPAIN.

Prof. J.-P. Hermand - Universite Libre de Bruxelles, Bruxelles, Belgium.

Dr. John Cozzens, National Science Foundation, USA

Prof. José Girón-Sierra, Dept. Arquitectura de Computadores y Automática, Universidad Complutense de Madrid, Madrid, Spain.

Prof. José M.F. Moura, Carnegie Mellon University, USA

Prof. Louis Scharf, University of Colorado, USA

Dr. Martin Siderius - Saclantcen Undersea Reaserch Centre, La Spezia, Italy.

Prof. Milica Stojanovic, Massachusetts Institute of Technology, USA

Prof. Mos Kaveh – University of Minnesota, USA

Prof. Rachid Deriche - INRIA, France.

Prof. Shariar Negahdariour - University of South Florida, Miami, USA.

Prof. Takeo Kanade - Carnegie Mellon University, USA.

Prof. Xiang – Gen Xia, University of Delaware, USA

3.9 SPECIAL EVENTS

3.9.1 INFANTE AND DELFIM SEA TRIALS

**Faial Island, Azores, Portugal
July 26 – August 15, 2002**

During a period of approximately 20 days, the DSORL of ISR carried out missions with the DELFIM autonomous surface craft (ASC) and the INFANTE autonomous underwater vehicle (AUV) at sea, in the Azores in cooperation with the IMAR/DOP/Univ. Azores. In the course of the mission, DELFIM was used as an advanced tool for automatic bathymetric data acquisition over an area of approximately 25 km² in the proximity of Faial island, Azores. These data are instrumental in obtaining a detailed map of the area upon which further biological and geological data will be superimposed. The INFANTE AUV was operated in an autonomous mode and carried out transects in the canal between the islands of Faial and Pico, at varying depths, under the supervision of its on-board resident Mission Control System.

3.9.2 SUMMER SCHOOL ON COOPERATIVE ROBOTICS

**Instituto Superior Técnico, Lisboa, Portugal
September 2 – September 7, 2002**

Organization of a Summer School on Cooperative Robotics, in the frame of EURON-The European Robotics Research Network. M. Isabel Ribeiro and João Sequeira acted as General Co-chair, together with Prof. Alessandro Saffiotti, and member of the Organizing Committee, respectively. The School took place at IST from 2 to 7 September 2002, and was attended by 40 participants, from which 31 were PhD students, from 12 different European countries. The School format included lectures, by a set of seven distinguished scientists, laboratory sessions, student presentations and a round table.

M. Isabel Ribeiro – Chair, IST/ISR

Alessandro Saffiotti – Chair, Orebro University, Sweden

Gerhard K. Kraetzschmar – Organizing Committee, University of Ulm, Germany

Pedro Lima - Organizing Committee, IST/ISR

João Sequeira - Organizing Committee, IST/ISR

Lecturers

The following teachers lecture in the Summer School:

- Rachid Alami (LAAS, France) -- Cooperative Planning
- Ronald Arkin (Georgia Tech, USA) -- Multi-Robot and Formation Control
- Daniele Nardi (Univ. of Rome, Italy) -- Reactivity and Deliberation in Multi-Robot Systems
- Milind Tambe (ISI, USA) -- Multiagent and Agent-Human Teamwork: Theory and Practice
- Steffen Gutmann (Sony, Japan) -- Cooperative Perception
- Martin Riedmiller (Univ. of Dortmund, Germany) -- Cooperative Learning

- Manuela Veloso (Carnegie-Mellon Univ., USA) -- Autonomous Multi-Robot Teams in Adversarial Environments

Sponsors:

EURON – European Robotics Research Network
Institute for Systems and Robotics

URL

<http://www.isr.ist.utl.pt/~euron>

3.9.3 BUILDING A JUNIOR FOOTBALL PLAYER FOR ROBÓTICA 2003

IST, Portugal
July 8-12 2002

Objectives: This was a workshop for High School students aiming at motivating them for the learning of Science and Technology, namely Robotics. The students had to build from an initial kit a team of two robots capable of playing football according to the rules of RoboCup Junior. In the process, they learned from several disciplines such as math, electronics, programming and mechanics, among others. In the end, the available teams played in a round-robin tournament. The workshop had the participation of 31 students from 12 schools. Many of them will now participate in the 3rd Edition of the Portuguese Robotics Festival, ROBOTICA 2003.

Coordinator: Pedro Lima.

Sponsors: Agência Nacional para a Cultura Científica e Tecnológica – Ciência Viva.

URL: <http://lci.isr.ist.utl.pt/projects/educational/cvnaferias/index2002.html>

3.9.4 ROBOTICS AND ARTIFICIAL INTELLIGENCE FOR HIGH SCHOOL STUDENTS

IST, Portugal
July 8-12 2002

Objectives: This was a workshop for High School students aiming at motivating them for the learning of Science and Technology. Among other activities, they learned basic Artificial Intelligence topics and how to build a robot, under the activities supervised by professors from the Intelligent Systems Lab of ISR.

Coordinators: Horácio Fernandes (IST Physics Department) Pedro Lima and Luis Custódio.

Sponsors: IST.

3.9.5 THE 10TH MEDITERRANEAN CONFERENCE ON CONTROL AND AUTOMATION (MED2002)

9-12 July 2002 – Lisbon, Portugal

João Sentieiro – General Chair, IST Full Professor, Director of ISR - Lisbon
Michael Athans – Program Chair, ISR/IST Principal Researcher, MIT Professor

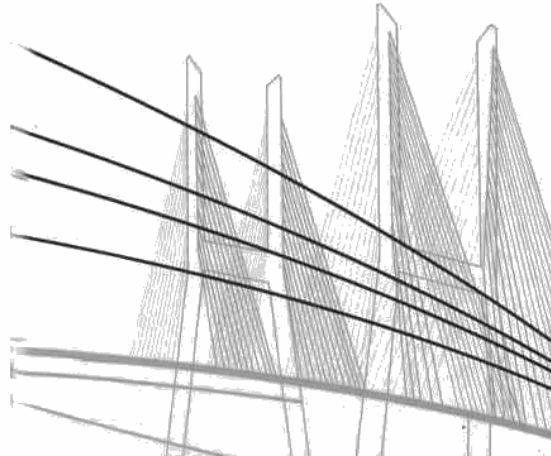

Sponsors:

IEEE Control Systems Society (technical co-sponsorship)
Mediterranean Control Association
Associação Portuguesa de Controlo Automático
Robótica
Fundação para a Ciência e a Tecnologia
ICCTI
Fundação Calouste Gulbenkian
The European Union

INTRODUCTION

The field of control and automation is a multidisciplinary technology area that is crucial for the analysis and design of systems that are critical in modern science and engineering. Applications include defense and aerospace systems, power and energy systems, transportation systems, consumer appliances and electronics, robotics, automated industrial processes, chemical and process control, marine systems and many others. Control and Automation methodologies are becoming increasingly important in macroeconomic and microeconomic studies, financial systems, system dynamics for emerging and mature industries, and socioeconomic systems.

In parallel with the exploding applications, during the past decade we have seen a great degree of progress in the development of novel theories, methodologies, and computer-aided design software for systems analysis and control system design. Such theoretical advances provide engineers and scientists with solid methodology foundations for the study of systems that are increasingly complex. Much remains to be done to develop relevant new theories and methodologies, since there is a “theory gap” for the class of applications that involve complex large-scale systems, decentralized/distributed decision making with increased dynamic uncertainty.

The 10th Mediterranean Conference on Control and Automation (MED2002) has been an international forum for exchanging ideas and information in all theoretical and applied aspects of systems, automation, control, estimation, operations research, signal processing, intelligent systems, communication networks and related disciplines.

We have provided - via special plenary keynote speakers, a rich variety of special invited sessions, and contributed papers - ample opportunities to discuss the state of the art in theoretical developments, design methodologies and algorithms, and significant applications of the theory to numerous fields.

The international Program Committee was composed by 98 distinguished members of the academic and industrial community, affiliated with reputed universities and companies in Europe (Austria, Croatia, Czech Republic, Finland, France, Germany, Greece, Holland, Hungary, Italy, Macedonia, Portugal, Slovak Republic, Spain, Sweden, Switzerland, Turkey, UK), USA, Canada, Japan, Australia, Israel and India, securing a first class technical conference.

Prior MED conferences have been held in Greece (4 times), Cyprus (2 times), Sardinia, Israel, and Croatia. Over the years, participation has expanded from the Mediterranean countries, to all Europe, the USA, Australia and Asian countries.

PLENARY LECTURES

During the 4 days of the Conference 8 plenary lectures were presented (2 each day). The topics and the lecturers were:

Domestic Robots - Prof. Henrik Christensen, Royal Institute of Technology, Sweden

Robustness and Complexity - Prof. John C. Doyle, California Institute of Technology, Pasadena, USA

High Performance Structures: Dynamics and Control - Prof. Ed. Crawley, MIT, Cambridge, Mass., USA .

Variational Methods in Computer Vision - Prof. Olivier Faugeras, INRIA, Sophia Antipolis, FRANCE and MIT, Cambridge, Mass., USA .

Ad-Hoc Wireless Networks: Protocols, Architecture and Convergence - Prof. P.R. Kumar, University of Illinois, Urbana-Champaign. USA.

From “Simple” to “Complex” Systems: Lessons and Examples – Prof. Munther Dahleh , MIT, Cambridge, Mass., USA.

Automating Control Design and Implementation - Prof. P. Varaiya, Univ. of California at Berkeley, USA

Systems Theory for Long-Term Investment - Prof. David G. Luenberger, Stanford University, USA.

INVITED SESSIONS

The technical program included 22 invited sessions. The topics and the organizers were:

Tutorial on Logic-Based Control: Switched Control Systems organized by João Hespanha, University of California at Santa Barbara, USA.

Tutorial on Logic-Based Control: Switched Supervisory Control organized by C. Liberzon, University of Illinois at Urbana, USA.

FMS and Industrial Robots: Control, Communications, Supervision organized by G.M. Dimirovski, Dogus University, Turkey.

Discret-Event Systems: Where We Have Come From, Where We Are organized by K. Rudie, Queens University, Canada.

Controlled Non-Holonomic Robot Applications: Environment organized by M.J. Allen, Wolverhampton University, UK.

Soft Computing Applications organized by Rita Ribeiro, Universidade Lusitana, Lisboa, Portugal

Automotive Control organized by A. Stefanopoulou, University of Michigan, USA.

Control of Complex Composite Nonlinear Systems organized by G.M. Dimirovski, Dogus University, Turkey.

Multi-Agent Systems organized by George Pappas, University of Pennsylvania, USA.

Nonlinear Modeling and Control of Chemical and Bio-Processes I organized by A. VandeWouwer, Mons Polytechnic, Belgium.

Nonlinear Modeling and Control of Chemical and Bio-Processes II organized by A. VandeWouwer, Mons Polytechnic, Belgium.

Dynamic games: Theory and Applications organized by J. B. Cruz Jr., Ohio State University, USA.

Impulsive Control: Theory and Applications I organized by F. Lobo Pereira, University of Porto, Portugal.

Impulsive Control: Theory and Applications II organized by F. Lobo Pereira, University of Porto, Portugal.

Control, Optimization and Computation organized by Fátima S. Leite, University of Coimbra, Portugal.

Navigation, Guidance and Control of Autonomous Vehicles I organized by António Pascoal, Institute for Systems and Robotics, IST, Portugal.

Modeling and Control of Biotechnological Processes organized by S. Caraman, University of Galati, Romania.

Modeling, Estimation and Control of Infinite Dimensional Systems I organized by M. A. Demetriou, Worcester Polytechnic Institute, USA.

Fault Detection and Isolation for Multivariable Systems organized by G. J. Balas, University of Minnesota, USA.

Navigation, Guidance and Control of Autonomous Vehicles II organized by Isaac Kammer, Naval Postgraduate School, USA.

Advances in Dynamics, Control, and Navigation for Mobile Robotic Systems organized by B. A. White, Cranfield University, United Kingdom.

Modeling, Estimation and Control of Infinite Dimensional Systems II organized by M. A. Demetriou, Worcester Polytechnic Institute, USA.

REGULAR SESSIONS

The papers submitted and accepted by the International Program Committee were presented in 33 regular sessions covering the following topics:

Adaptive Control	Fuzzy Control,	Power Systems,	Production Systems,	Image Processing Applications	Neural Networks	Adaptive Systems
Energy Systems	Vision Based Control	Controller Design	Robust Control	Identification	Stability	Signal Processing
Intelligent Systems	Robust Stability	Stochastic Systems	Distributed/Decentralized Systems	Hybrid Systems	Systems Modelling	Linear Control
Robotics	Filtering	Non-Linear Systems	Networks	Control Methods	Failure Detection	Process Control
Optimal Control	Non-Linear Control.					

A SPECIAL LECTURE

As part of the Conference program a special lecture entitled "Systems and Controls: Evolution and Opportunities" was presented by Dr. Alkis Konstantellos of the E.U.. In this talk Dr. Konstantellos has presented an overview of the current and new European R&D programmes for the period 2003-2006.

PROCEEDINGS

The conference presentations, are documented in a CD ROM and in a Book of Abstracts. The plenary talks will be available soon in the web page of the Conference at:

<http://www.isr.ist.utl.pt/med2002>

We shall disseminate the book of Abstracts together with a CD-ROM widely in the scientific community and in Portuguese and European agencies.

CONCLUSIONS

During the 4 days of the Conference the participants were exposed to new ideas and trends that represent the state of the art in the fields of Control, Automation, Robotics and related areas. Also new avenues for future promising research were identified. We have managed to join in the Conference a large number of senior scientists together with a younger generation of top-notch researchers affiliated to the most prestigious international institutions in Europe and in the United States of America.

The Conference was attended by more than 200 researchers from 39 countries covering all 5 continents.

It was also an opportunity to expose to an international audience the late progresses made by the Portuguese scientific community.

3.10 AWARDS

2002 IBM Science Prize, **João Lourenço Maciel**

Best paper award from the *Encontro Científico do Robótica 2002 - Festival Nacional de Robótica, 2002*, **Duarte C. Leão**, Tiago C. Pereira, **Pedro U. Lima** e **Luís M. M. Custódio**, “Planeamento de Trajectórias usando Caminhos de Curvatura Contínua”.

Best Paper Award of the Symposium and Meeting in the ACE2002, EMCSR'2002, Vienna, Austria, 2002, **Sandra Gadanho**, “Emotional and Cognitive Adaptation in Real Environments”.

Luis Braga Campos – Von Karman medal, Research and Technology Organization, Nat.

3.11 PUBLICATIONS

A) M.Sc. THESES (5):

- [1] **Rita Cunha** - "Modeling and Control of an Autonomous Robotic Helicopter," Instituto Superior Técnico, July 2002, Portugal.
- [2] **João da Silva Gomes Mota**, - "Localisation of a Mobile Robot using Laser Scanner and Reconstructed 3D Models", M.Sc Thesis, IST, May 2002.
- [3] **João Pina** - "Operation and Control of a Glass Melting Furnace" Instituto Superior Técnico, November 2002 , Portugal
- [4] **Rui Melo Tavares**, "Algoritmos Evolutivos: Paradigma Infecção Genética" MSc Thesis, Instituto Superior Técnico, April 2002, Lisboa, Portugal.
- [5] **Carlos Fernandes**, "Population based Genetic Algorithms", MSc Thesis, Instituto Superior Técnico, April 2002, Lisboa, Portugal.

B) Ph.D. THESES (10):

- [6] **Paulo Oliveira**, "Periodic and Non-Linear Estimators with Applications to the Navigation of Ocean Vehicles," Instituto Superior Técnico, July 2002, Portugal.
- [7] **Pedro Encarnação**, "Nonlinear Path Following Control Systems for Ocean Vehicles," Instituto Superior Técnico, April 2002, Portugal.
- [8] **Pedro Aguiar**, "Nonlinear Motion Control of Nonholonomic and Underactuated Systems," Instituto Superior Técnico, April 2002, Portugal.
- [9] **Etienne Grossmann** "Maximum Likelihood 3D Reconstruction From One or More Uncalibrated Views Under Geometric Constraints", Instituto Superior Técnico, October 2002
- [10] **Niall Winters** ,A Holistic Approach to Mobile Robot Navigation using Omnidirectional Vision, , Ph.D. Thesis, (University of Dublin, Trinity College, Ireland, co-supervised at IST/ISR) – January 2002.
- [11] **João Lourenço Teixeira Lopes de Sousa Maciel** "Global Matching: optimal solution to correspondence problems" Instituto Superior Técnico , April 2001.
- [12] **Paulo Mónica de Oliveira**, "Physical Constraints on the Time-Frequency Plane," IST-UTL, 2002.
- [13] **João Pedro C.P. Santos Gomes**, "Array Processing Methods for Time-Reversed Underwater Communication Systems," IST-UTL, 2002.
- [14] **João Manuel de Freitas Xavier**, "Blind Identification of MIMO Channels Based on 2nd Order Statistics and Colored Inputs – The Riemannian Geometry of Algorithms, Performance Analysis and Bounds over the Quotient Manifold of Identifiable Channel Classes," IST-UTL, 2002.
- [15] **Paulo Tabuada** "Hierarchies and Compositional Abstractions of Hybrid Systems" Instituto Superior Técnico, January 2002, Portugal.

C) BOOKS (2):

[16] **M. Isabel Ribeiro**, *Análise de Sistemas Lineares*, IST Press, March 2002, ISBN 972-8469-13-6, 828 pps.

[17] **Isabel M. G. Lourtie**, *Sinais e Sistemas*, Escolar Editora, 2002.

D) IN BOOKS (12):

[18] **C. Marques, P. Lima**, "Multi-Sensor Navigation for Soccer Robots", *RoboCup 2001 Book*, Springer-Verlag, Berlin, July 2002

[19] **Gong HongFei, Agostinho Rosa**. "Simulation of Olive Fly Development Using Artificial Life Technic". Versão Extendida no "Computational Intelligence and Control". M Mohammadian (Edt), Chapter XI, pp 183-196, 2002.

[20] **Tito Silva, Agostinho Rosa**. "Visual Objects Representation using Features Network". In "Advances in Neural Networks World", A Grmela, N Mastorkis (Eds), pp 123-129, WSEAS Press, 2002.

[21] **Cristian Munteanu, Agostinho Rosa**. "Adaptive Reservoir Genetic Algorithm: Convergence Analysis". In "Advances in Intelligent Systems, Fuzzy Systems, Evolutionary Computation", A Grmela, N Mastorkis (Eds), pp 235-238, WSEAS Press, 2002.

[22] **Cristi Munteanu, Agostinho Rosa**. "Adaptive Reservoir Genetic Algorithm with on-line decision making", PPSN VII, Lectures Notes in Computer Science 2439, pp 432-441, Springer-Verlag, 2002.

[23] **Fernandes C, Caldeira JP, Rosa AC**. "Infected Genes Evolutionary Algorithm for School Timetabling", In "Advances in Intelligent Systems, Fuzzy Systems, Evolutionary Computation", A Grmela, N Mastorkis (Eds), pp 245-249, WSEAS Press, 2002.

[24] **Alexandre Bernardino, José Santos-Victor and Giulio Sandini, in V. Cantoni, A. Petrosino & M. Marinaro (eds.)**, Model Based Attention Fixation Using Log-Polar Images, "Visual Attention Mechanisms", Plenum Press, New York, 2002.

[25] **Jesus S.M.**, "Model-based correlators: interesting cases in shallow water acoustics.", in Selected Topics in the New Acoustics, pp.133-148, CSIC, Madrid (Spain), 2002.

[26] **J. M. Hans du Buf**, Automatic diatom identification, World Scientific, Series in Machine Perception and Artificial Intelligence, Vol. 51, pp 316, 2002

[27] **R.E. Loke and Hans du Buf**, Identification by curvature of convex and concave segments. Chapter 8 in : Automatic diatom identification, pp 141-166, Hans du Buf and M. M. Bayer (eds), 2002

[28] **A. Ciobanu and Hans du Buf**, Contour profiling and Legendre Polynomials, Chapter 9 in: Automatic diatom identification, 167-186, Hans du Buf and M. M. Bayer (eds), 2002

[29] **L. M. Santos and Hans du Buf**, Identification by Gabor features, Chapter 10 in: Automatic diatom identification, 187-220, Hans du Buf and M. M. Bayer (eds), 2002

E) IN INTERNATIONALS JOURNALS (29) :

- [30] **C. Silvestre, A. Pascoal, I. Kaminer** "On the Design of Gain-Scheduled Trajectory Tracking Controllers," *International Journal of Robust and Nonlinear Control*, 12:797-839, 2002.
- [31] **H.-D. Burkhard, D. Duhaut, M. Fujita, P. Lima, R. Murphy, R. Rojas**, "Towards a Research RoadMap for RoboCup", *IEEE Robotics and Automation Magazine*, Vol. 9, No. 2, June 2002, 2002.
- [32] **P. Lima, T. Balch, M. Fujita, R. Rojas, M. Veloso, H. Yanco**, "The RoboCup 2001 Competitions and Conference: Report and Research Issues", *IEEE Robotics and Automation Magazine*, Vol. 9, No. 2, June 2002, 2002.
- [33] **MG Terzano, L Parrino, A Smerieri, R Chervin, S Chokroverty, C Guilleminault, M Hirshkowitz, M Mahowald, H Moldofsky, A Rosa, R Thomas, A Walters**. "Atlas, rules and recording techniques for the scoring of cyclic alternating pattern (CAP) in human sleep". *Sleep Medicine*, 3:187-199, 2002.
- [34] **D Poyares, C Guilleminault, AC Rosa, M Ohayon, U Koester**. "Arousal, EEG Spectral Power and Pulse Transit Time in UARS and Mild OSAS Subjects". *Clinical Neurophysiology* 113 (10) : 1579, 2002.
- [35] **Alexandre Calapez, Henrique M Pereira, Angelo Calado, José Braga, José Rino, Célia Carvalho, João Paulo Tavanez, Elmar Wahle, Agostinho C Rosa, Maria Carmo-Fonseca**. "The intranuclear mobility of messenger RNA binding proteins is ATP dependent and temperature sensitive". *Journal of Cell Biology*, Volume 159, Number 5, December 9 , 2002, pp 795-805.
- [36] **AC Rosa, DL Poyares, C Guilleminault, U Koster**, "Are K Complexes and Delta Waves Different: A Mathematical Model and its Applications". *Sleep* vol 25, AS 2002, A414-A415. (abs)
- [37] **R Largo, AC Rosa**. "Automatic CAP Power Classification by Wavelet Transform". *Journal of Sleep Research* Vol.11, Supp 1, pp133, 2002. (abs)
- [38] **Niall Winters, José Santos-Victor**, Information Sampling for vision-based robot navigation, *Robotics and Autonomous Systems* (Elsevier), 41(2-3), November 2002.
- [39] **Sjoerd van der Zwaan, Alexandre Bernardino, José Santos-Victor** , Visual station keeping for floating robots in unstructured environments, *Robotics and Autonomous Systems* (Elsevier), 39(3-4), June 2002.
- [40] **Alexandre Bernardino, José Santos-Victor, Giulio Sandini**, Foveated Active Tracking with Redundant 2D Motion Parameters, *Robotics and Autonomous Systems* (Elsevier), 39(3-4), June 2002.
- [41] **João Maciel, João Paulo Costeira**, Robust point correspondence by concave minimization, *Image and Vision Computing* , 20 (2002) 683-690.
- [42] **Jacinto Nascimento, Jorge S. Marques**, Robust Multi-Model Filter for Shape Tracking in the Presence of Outliers, *Pattern Recognition*, Vol. 35, 2711-2718, Dez. 2002.
- [43] **Jorge S. Marques, João M. Lemos, Arnaldo Abrantes**, A HMM Approach to the Estimation of Random Trajectories on Manifolds, *Signal Processing*, Vol. 82, 1205-1214, Set. 2002.
- [44] **João M. Sanches, Jorge S. Marques**, A Multi-Scale Algorithm for Three Dimensional Free Hand Ultrasound, *Ultrasound in Medicine and Biology*, Vol. 28, 1029-1040, August 2002.
- [45] **João Sanches, Jorge S. Marques**, Joint Image Registration and Volume Reconstruction for 3D Ultrasound, *Pattern Recognition Letters*, Special Issue on Ultrasonic Image Processing and Analysis, vol 24, 799-808, Dec. 2002.
- [46] **Soares C., Siderius M. and Jesus S.M.,**"MFP source localization in the Strait of Sicily", *Journal of the Acoustical Society of America*, Vol.112(5), pp. 1879 - 1889, December 2002.

- [47] **Rodriguez O.C. and Jesus S.M.**, "Range-dependent regularization of travel-time tomography based on theoretical modes", *ACTA ACUSTICA*, vol.88, p.760-762, November 2002.
- [48] **Palmese M., Bozzo A., Jesus S., Onofre J., Picco P. and Trucco A.**, "Observation of Acoustical Signal Fluctuations by Time-Frequency Analysis Methods", *ACTA ACUSTICA*, vol.88, p.653-657, November 2002.
- [49] **R.E. Loke and J.M. Hans du Buf**, "Quadtree-guided 3D interpolation of irregular sonar data sets", *IEEE Journal of Oceanic Engineering*, 2002.
- [50] **R.E. Loke and J.M. Hans du Buf**, "3D data segmentation by means of adaptive boundary refinement in an octree", *Pattern Recognition*, 2002
- [51] **L. Santos and J.M. Hans du Buf**, "Vision-inspired wavelet-based contour and texture methods in diatom recognition", *Electronic Letters on Computer Vision and Image Analysis*, 2002.
- [52] **R.E. Loke , M.M: Bayer, D.G. Mann and J.M. Hans du Buf**, " Diatom contour classification by curvate of convex and concave segments ", *Pattern Recognition*, 2002
- [53] **J.M. Hans du Buf, M.M. Bayer, H. Bunke, A. Ciobanu, G. Cristobal, S. Fischer, J. Huerlimann, A.C. Jalba, S. Juggins, M.G. Kelly, R.E. Loke, B. Ludes, D.G. Mann, J.L. Pech-Pacheco, J.B.T.M. Roerdink, L.M. Santos, H. Shahbazkia, H., R.L. Telford, E.R. Urbach, M.A. Westenberg and M.H.F. Wilkinson**, " Automatic diatom analysis: from slide scanning to species identification, *Hydrobiologia*, 2002.
- [54] **Luis Braga Campos , Paulo Gil** , "On Alfvén waves convected by a radial flow in a non-uniform magnetic field", *Wave Motion* 36 (3), 203-220, 2002.
- [55] **Fernando Lau, Luis Braga Campos**, "On the effect of wall undulations on the acoustics of ducts with flow", *J. Sound Vib.* , 2002.
- [56] **Luis Braga Campos & J. Marques**, "On safety metrics related to aircraft separation", *Journal of the Royal Institute of Navigation*, Volume 55, pages 39-63, 2002.
- [57] **Luis Braga Campos**, "On the derivation of asymptotic expansions for special functions from the corresponding differential equations", *Integral Transforms and Special Functions*, Volume 12, pages 227-236, 2002.
- [58] **Luis Braga Campos , Paulo Gil**, "On Alfvén waves convected by radial flow in a non-uniform magnetic field, *Wave Motion*, Volume 36, pages 202-220.

F) IN NATIONAL JOURNALS (1)

- [59] **Duarte C. Leão, Tiago C. Pereira, Pedro U. Lima e Luís M. M. Custódio**, "Planeamento de Trajectórias usando Caminhos de Curvatura Contínua", *Robótica*, Nº 48-49, 2002, selected paper from the *Actas do Encontro Científico do Robótica 2002 - Festival Nacional de Robótica*, 2002

G) IN INTERNATIONAL CONFERENCES (74)

- [60] **A. Aguiar, A. Pascoal**, "Dynamic Positioning of an Underactuated AUV in the Presence of a Constant Unknown Current Disturbance," *Proc. 15th IFAC World Congress*, Barcelona, Spain, July 2002.
- [61] **P. Encarnação, A. Pascoal**, "Combined Trajectory Tracking and Path Following Control for Dynamic Wheeled Mobile Robots," *Proc. 15th IFAC World Congress*, Barcelona, Spain, July 2002.
- [62] **P. Oliveira, A. Pascoal, I. Kaminer**, "A Nonlinear Vision Based Tracking System for Coordinated Control of Marine Vehicles," *Proc. 15th IFAC World Congress*, Barcelona, Spain, July 2002.
- [63] **A. Aguiar, A. Pascoal**, "Stabilization of an Underactuated Autonomous Underwater Vehicle Via Logic-Based Hybrid Control," *Proc. MED2002 Conference*, Lisbon, Portugal, July 2002.
- [64] **R. Cunha, C. Silvestre, A. Pascoal**, "Path Following Controller for an Autonomous Helicopter," *Proc. MED2002 Conference*, Lisbon, Portugal, July 2002.
- [65] **A. Aguiar, A. Pascoal**, "Way-Point Tracking of Underactuated AUVs in the Presence of Ocean Currents," *Proc. MED2002 Conference*, Lisbon, Portugal, July 2002.
- [66] **A. Aguiar, A. Pascoal**, "Practical Stabilization of the Extended Nonholonomic Double Integrator," *Proc. MED2002 Conference*, Lisbon, Portugal, July 2002.
- [67] **A. Aguiar, A. Pascoal**, "Dynamic Positioning and Way-Point Tracking of Underactuated AUVs in the Presence of Ocean Currents," *Proc. IEEE Conference on Decision and Control*, USA, December 2002.
- [68] **A. Aguiar, A. Pascoal**, "Global Stabilization of an Underactuated Autonomous Underwater Vehicle Via Logic-Based Hybrid Control," *Proc. IEEE Conference on Decision and Control*, USA, December 2002.
- [69] **A. Sajjad, M. Athans and A. Pascoal**, "Estimation and Identification of Mass-Spring-Dashpot Systems Using Multiple-Model Adaptive Algorithms", 2002 ASME International Mechanical Engineering Congress, November 17-22, 2002, New Orleans, USA.
- [70] **Francisco M. Garcia, Isabel M. G. Lourtie, Jorge Buescu**, "Local Stationarity of L2(R) Processes", 2002 International Conference on Acoustic, Speech and Signal Processing, Orlando, Florida, USA, May 2002.
- [71] **S. Marques, P. Tabuada, P. Lima**, "Small Satellites Attitude Determination Using a Predictive Algorithm for Attitude Stabilization and Spin Control", *Proc. of IEEE Mediterranean Conference on Control and Automation, MED-2002*, Lisboa, 2002
- [72] **J. Pina, P. Lima**, "An Operation System for Industrial Processes: Application to a Glass Furnace", *Proc. of IEEE Mediterranean Conference on Control and Automation, MED-2002*, Lisboa, 2002
- [73] **P. Tabuada, G. J. Pappas, P. Lima**, "Formation Feasibility in the Presence of Observations", *Proc. of IEEE Mediterranean Conference on Control and Automation, MED'2002*, invited session on Multi-Agent Systems, Lisboa, 2002
- [74] **B. Damas, L. Custódio, P. Lima**, "A Modified Potential Fields Method for Robot Navigation Applied to Dribbling in Robotic Soccer", *Proc. of RoboCup 2002 Symposium*, Fukuoka, Japan, 2002
- [75] **P. Tabuada, G. J. Pappas, P. Lima**, "Composing Abstractions of Hybrid Systems", *Proceedings of the Hybrid Systems: Computation and Control, 5th Int. Workshop*, Stanford, CA, 2002
- [76] **D. Milutinovic, P. Lima**, "Petri Net Models of Robotic Tasks", *Proceedings of IEEE Int. Conference on Robotics and Automation*, Washington D.C., 2002

- [77] **Sandra Gadanho, Luis Custódio**, Asynchronous Learning by Emotions and Cognition, In From Animals to Animats VII, Proceedings of the Seventh International Conference on Simulation of Adaptive Behavior (SAB'02), Edinburgh, UK, 2002
- [78] **Sandra Gadanho**, Emotional and Cognitive Adaptation in Real Environments, In ACE2002, EMCSR'2002, pg. 762-767, Vienna, Austria, 2002. (Best Paper Award of the Symposium and Meeting)
- [79] **Rodrigo Ventura, Carlos Pinto-Ferreira**, From Reactive to Emotion-based Agents: a prescriptive model, In ACE2002, EMCSR'2002, pg. 757-761, Vienna, Austria, 2002.
- [80] **Rodrigo Ventura, Carlos Pinto-Ferreira**, A Formal Indexing Mechanism for an Emotion-based Agent, Proc. International Conference on Artificial Intelligence and Applications 2002 (IASTED), special session on Automated Reasoning: Perception and Emotions, Malaga, Spain, 2002.
- [81] **Silva A. and Jesus S.M.**, "Underwater Communications Using Virtual Time Reversal in a Variable Geometry Channel", IEEE/MTS Oceans'2002, Biloxi, USA, October 2002.
- [82] **Jesus S.M. and Silva A.**, "Virtual Time - Reversal in Underwater Communications: Results on the INTIFANTE'00 Sea Trial", Forum Acusticum, Sevilla, Spain, September 2002 (Invited).
- [83] **Martins N.E. and Jesus S.M.**, "Blind Channel Estimation with Data from the INTIMATE'96 sea trial", MED'2002, Lisboa, Portugal, July 2002.
- [84] **De Marinis E., Gasparini O., Picco P., Jesus S.M., Crise A. and Salons.**, "Passive Ocean Acoustic Tomography: theory and experiment", ECUA'02, Gdansk, Poland, June 2002.
- [85] **Palmese M., Bozzo A., Jesus S., Onofre J., Picco P. and Trucco A.**, "Observation of Acoustical Signal Fluctuations by Time-Frequency Analysis Methods", ECUA'02, Gdansk, Poland, June 2002.
- [86] **Rodriguez O.C. and Jesus S.M.**, "Range-dependent regularization of travel-time tomography based on theoretical modes", ECUA'02, Gdansk, Poland, June 2002.
- [87] **Jesus S.M., Soares C., Onofre J and Picco P.**, "Blind Ocean Acoustic Tomography: experimental results on the INTIFANTE'00 data set" ECUA'02, Gdansk, Poland, June 2002 (invited).
- [88] **Martins N., Jesus S., Gervaise C. and Quinquis A.**, "Time-Frequency approach to multipath underwater channel deconvolution", ICASSP'02, Orlando, USA, May 2002.
- [89] **Pedro Vale, Luis Custódio**, Combining Reinforcement Learning with an Emotion based Architecture, Proc. International Conference on Artificial Intelligence and Applications 2002 (IASTED), special session on Automated Reasoning: Perception and Emotions, Malaga, Spain, 2002.
- [90] **Atila Neves, Osvaldo Brasao, Agostinho Rosa**. "Learning the Risk board Game with Classifier Systems". Proc. ACM SAC'02, pp 585-589, 2002.
- [91] **Tito Silva, Agostinho Rosa**. "Representation, Recognition and Reconstruction of Objects through a Features Network". Proc. IJCNN - WCCI, pp 1602-1607, 2002.
- [92] **Alberto Vale, M. Isabel Ribeiro**, "A Probabilistic Approach for the Localization of Mobile Robots in Topological Maps", Proceedings da 10th IEEE Mediterranean Conference on Control and Automation, Lisbon, Portugal, July 2002.
- [93] **André Lourenço, Pedro Freitas, M. Isabel Ribeiro, Jorge Salvador Marques**, "Detection and Classification of 3D Moving Objects", Proceedings da 10th IEEE Mediterranean Conference on Control and Automation, Lisbon, Portugal, July 2002.
- [94] **João Gomes, Victor Barroso**. Time-Reversed Communication over Doppler-Spread Underwater Channels. Proc. IEEE International Conference on Acoustics, Speech and Signal Processing, ICASSP 2002, Orlando, USA, May 2002.

- [95] **J. Xavier, V. Barroso.** Intrinsic Distance Lower Bound for Unbiased Estimators on Riemannian Manifolds. Proc. IEEE International Conference on Acoustics, Speech and Signal Processing, ICASSP 2002, Orlando, USA, May 2002.
- [96] **J. Xavier, V. Barroso.** Prewhitening of Mixing Matrices: Impact on the Contraction of Their Probability Mass Priors. Proc. International Symposium on Information Theory, ISIT2002, Lausanne, Suíça, July 2002.
- [97] **J. Xavier, V. Barroso.** Intrinsic Variance Lower Bound for Inference Problems on Riemannian Manifolds. Proc. 10th Mediterranean Conference on Control and Automation - MED2002- Lisboa, Portugal, July 2002.
- [98] **João Xavier, Victor Barroso, and Tiago Patrão.** Joint Symbol Detection and Multi-Channel Acquisition in Fast-Fading Narrowband Wireless Environments. Proc. International Telecommunications Symposium, ITS2002, Natal, Brazil, September, 2002.
- [99] **João Xavier, Victor Barroso, and Paulo Lopes.** Blind Source Separation and Channel Identification: Exploiting 2nd-Order Statistics in Bayesian Frameworks. Proc. International Telecommunications Symposium, ITS2002, Natal, Brazil, September, 2002.
- [100] **Paulo M. Oliveira, Victor Lobo, Victor Barroso and Fernando Moura-Pires.** Detection and Classification of Underwater Transients with Data Driven Methods Based on Time-Frequency Distributions and Non-Parametric Classifiers. Proc. IEEE International Conference on Oceanic Engineering, Oceans '02, Biloxi, Mississippi, USA, October, 2002.
- [101] **João M. Sanches, Jorge S. Marques,** A MAP IIR Filter for 3D Ultrasound, IEEE International Conference on Image Processing, Rochester, 957-960, Vol. II, Set. 2002.
- [102] **Arnaldo J. Abrantes, Jorge S. Marques, João M. Lemos,** Long Term Tracking Using Bayesian Networks, IEEE International Conference on Image Processing, Rochester, 609-612, vol. III, Set. 2002.
- [103] **João M. Lemos, Rui N. Silva, Jorge S. Marques,** Adaptive Control of the Ball and Beam Plant in the Presence of Sensor Measurement Outliers, American Control Conference, aceite, 2002.
- [104] **André Lourenço, Pedro Freitas, Isabel Ribeiro, Jorge Marques,** Detection and Classification of 3D Moving Objects, 10th Mediterranean Conference on Control and Automation, accepted, Lisbon, July 2002.
- [105] **Rui M. Jesus, Arnaldo J. Abrantes, Jorge S. Marques,** Tracking of Human Body using Multiple Predictors, Second International Workshop on Articulated Motion and Deformable Models, Maiorca Nov. 2002.
- [106] **João M. Lemos, Rui N. Silva, Jorge S. Marques,** Adaptive Control in the Presence of Sensor Measurement Outliers, 10th Mediterranean Conference on Control and Automation, accepted, Lisbon, July 2002.
- [107] **João M. Sanches, Jorge S. Marques,** A 3D Ultrasound Algorithm with Alignment and Nonlinearity Compensation, 2nd Workshop on Pattern Recognition in Information, Systems, 156-172, Alicante, April 2002.
- [108] **Rui F. C. Guerreiro and Pedro M. Q. Aguiar,** Factorization with missing data for 3D structure recovery, IEEE International Workshop on Multimedia Signal Processing MMSP'02, St. Thomas, USA, December 2002.
- [109] **Pedro M. Q. Aguiar and José M. F. Moura,** 3D Rigid structure from video: what are "easy" shapes and "good" motions ? , IEEE International Workshop on Multimedia Signal Processing MMSP'02, St. Thomas, USA, December 2002.
- [110] **Rui F. C. Guerreiro and Pedro M. Q. Aguiar,** 3D Structure from video streams with Partially overlapping images, IEEE International Conference on Image Processing ICIP'02, New York, USA, September 2002.
- [111] **Natacha Domingues, João Lacerda, Pedro M. Q. Aguiar, and Cristina V. Lopes,** Aerial communications using piano, clarinet, and bells, Natacha Domingues, João Lacerda, Pedro M. Q. Aguiar, and Cristina V. Lopes, IEEE International Workshop on Multimedia Signal Processing MMSP'02, St. Thomas, USA, December 2002.

- [112] **José Moreira, Carlos Bispo**, Stability or Stabilizability? Seidman's FCFS example revisited, 10th Mediterranean Conference on Control and Automation, Lisbon, July 2002.
- [113] **Alexandre Bernardino, José Santos-Victor**, A Binocular Stereo Algorithm for Log-polar Foveated Systems, 2nd Workshop on biological motivated Computer Vision, BMCV 2002, Tuebingen, Germany, November 2002.
- [114] **Rafal Nojek, Tomasz Krzyzynski João Paulo Costeira**, Representing 3D shape from video, Proceedings of the third international workshop on robot motion and control, , Bukowy Dworek, Poland, November 2002
- [115] **Raquel Vassallo, José Santos-Victor, Hans-Jorg Schneebeli**, Using Motor Representations for Topological Mapping and Navigation, Intl. Conference on Intelligent Robots and Systems, IROS 2002, Lausanne, Switzerland, October 2002.
- [116] **Etienne Grossmann, José Santos-Victor**, Maximum Likelihood 3D Reconstruction from One or More Images Under Geometric Constraints, British Machine vision Conference, BMVC2002, Cardiff, UK, September 2002.
- [117] **Marco Zucchelli, José Santos-Victor, Henrik Christensen**, Multiple Plane Segmentation Using Optical Flow, British Machine vision Conference, BMVC2002, Cardikk, UK, September 2002.
- [118] **Marco Zucchelli, José Santos-Victor, Henrik Christensen**, Constrained Structure and Motion Estimation from Optical Flow, International Conference on Pattern Recognition, ICPR, Quebec, Canada, August 2002.
- [119] **Marco Zucchelli, José Santos-Victor, Henrik Christensen**, Maximum Likelihood Structure and Motion Estimation Integrated over Time, International Conference on Pattern Recognition, ICPR, Quebec, Canada, August 2002.
- [120] **João Maciel, João Costeira**, Maximizing Rigidity: Optimal matching under scaled-orthography, European conference on computer Vision, ECCV, Copenhagen, Denmark, June 2002.
- [121] **José Gaspar, Claudia Deccó, Jun Okamoto Jr, José Santos-Victor**, Constant Resolution Omnidirectional Cameras, OMNIVIS'02 - Workshop on Omnidirectional Vision, held with ECCV, Copenhagen, Denmark, June 2002.
- [122] **Raquel Vassallo, José Santos-Victor, Hans-Jorg Schneebeli**, A General Approach for Egomotion Estimation with Omnidirectional Images, OMNIVIS'02 - Workshop on Omnidirectional Vision, held with ECCV, Copenhagen, Denmark, June 2002.
- [123] **Javier Minguez, Luis Montano, Jose Santos-Victor**, Reactive Navigation for Non-holonomic Robots using the Ego-Kinematic Space, ICRA - IEEE International Conference on Robotics and Automation, Washington D.C., May 2002.
- [124] **Etienne Grossmann and Diego Ortin and José Santos-Victor**, Single and Multi-View Reconstruction of Structured Scenes, Proc. ACCV - Asian Conference on Computer Vision, Melbourne, January 2002.
- [125] **J.M. Hans du Buf and U. Bobinger**, In search of the Holy Grail: a unified special detection model, 25th European conference on Visual Perception, Glasgow, August 25-29, 2002.
- [126] **R.E. Loke, M. M. Bayer, D. G. Mann and J.M. Hans du Buf**, Diatom recognition by convex and concave contour curvature, MTS/IEEE Conference OCEANS'02, Biloxi, Mississippi, Oct 2002.
- [127] **L.M. Santos and J.M. Hans du Buf**, Computational cortical cell models for continuity and texture, Biologically Motivated Computer Vision Workshop, Tuebingen, November 2002.
- [128] **Luis Braga Campos & P. Mendes** "On the effect of anisotropic resistivity on solar atmospheric heating", *Magnetic Coupling of the Solar Atmosphere*, IAU Coll. 188, Santorini, ESA SP-505, pages 373-376, 2002.
- [129] **Luis Braga Campos & N. Isaeva** "On the critical layer of Alfvén waves in the solar wind", *SOLMAG: Magnetic Coupling of the Solar Atmosphere*, IAU Coll. 188 Santorini, ESA SP-505, pages 369-372, 2002

- [130] **Luis Braga Campos & J. Oliveira** “On the effect of non-uniform wall impedance on the acoustics of nozzles”, *23rd Congress, of the International Council of Aeronautical Sciences, Toronto, 2002.*
- [131] **Luis Braga Campos & M. Kobayashi** “On the transmission of sound across a non-isothermal boundary layer” *23rd Congress, of the International Council of Aeronautical Sciences, Toronto, 2002.*
- [132] **Luis Braga Campos & J. Marques** “On wake vortex response for several combination of leading and following aircraft”, *23rd Congress, of the International Council of Aeronautical Sciences, Toronto, 2002.*
- [133] **Luis Braga Campos & J. Marques** “On the calculation of collision probabilities as an assurance of safe separation between aircraft”, *23rd Congress, of the International Council of Aeronautical Sciences, Toronto, 2002.*

H) IN NATIONAL CONFERENCES (9) :

- [134] **A. Aguiar, A. Pascoal**, “Global Stabilization of an Underactuated AUV Via Logic-Based Hybrid Control,” *Proc. CONTROLO 2002 Conference, Aveiro, Portugal, September 2002.*
- [135] **A. Aguiar, A. Pascoal**, “From Local to Global Stabilization: a Hybrid System Approach,” *Proc. CONTROLO 2002 Conference, Aveiro, Portugal, September 2002.*
- [136] **Bruno D. Damas, Pedro U. Lima, Luis M. Custódio**, “Navegação Entre Obstáculos Usando Um Método de Campos de Potencial Modificados”, *Actas do Encontro Científico do Robótica 2002 - Festival Nacional de Robótica, 2002*
- [137] **Pedro Lima, Luis Custódio**, “Artificial Intelligence and Systems Theory Applied to Cooperative Robots: the SocRob Project”, *Actas do Encontro Científico do Robótica 2002 - Festival Nacional de Robótica, 2002.*
- [138] **Jacinto Nascimento, Arnaldo J. Abrantes, Jorge S. Marques**, The Role of Middle level features for robust shape tracking, *12th Portuguese Conference on Pattern Recognition, Aveiro, July 2002.*
- [139] **João Sanches, Jorge S. Marques**, A Recursive Filter for 3D MAP reconstruction, *12th Portuguese Conference on Pattern Recognition, Aveiro, July 2002.*
- [140] **L.M. Santos and J.M. Hans du Buf**, Pattern detection using cortical cell models, *12th Portuguese Conference on Pattern Recognition, Aveiro, July 2002.*
- [141] **R. E. Loke and J.M. Hans du Buf**, Diatom contour classification by curvature of convex and concave segments, *12th Portuguese Conference on Pattern Recognition, Aveiro, July 2002.*
- [142] **Sérgio Guerreiro, José Tribolet, João Sequeira**, "Reorganização Dinâmica em Situações de Gestão de Crise", *3^a Conferência da Associação Portuguesa de Sistemas de Informação, Coimbra, Portugal, November 2002.*

I) TECHNICAL REPORTS (21) :

- [143] **Lapierre, D. Soetanto, and A. Pascoal**, “Coordinated Motion Control of Marine Robots,” *DSORL-ISR Technical Report, December 2002.*
- [144] **R. Cunha, C. Silvestre**, “ Dynamic modeling and stability analysis of model-scale helicopters with Bell-Hiller stabilizing bar, “ *DSORL-ISR Technical Report, December 2002.*
- [145] **D. Labbe, P. Wilson, P. Weiss, L. Lapierre**, “FreeSub : Navigation, Guidance, and Control Systems for an Intervention AUV,” *joint DSORL/FREESUB report, December 2002.*
- [146] **C. Silvestre and A. Pascoal**, “Control of the INFANTE AUV Using Gain Scheduled Static Output Feedback,” *DSORL-ISR Technical Report, November 2002.*

- [147] **L. Lapierre, D. Soetanto, A. Pascoal**, “Nonlinear Path Following Control of Autonomous Underwater Vehicles,” DSORL-ISR Technical Report, October 2002.
- [148] **R. Cunha, C. Silvestre**, “ SimModHeli: A dynamic simulator for model-scale helicopters, “ DSORL-ISR Technical Report, October 2002.
- [149] **L. Lapierre, D. Soetanto, A. Pascoal**, “Adaptive, Non-linear Vision-based Path Following Control of a Wheeled Robot,” DSORL-ISR Technical Report, September 2002.
- [150] **L. Lapierre, D. Soetanto, A. Pascoal**, “Unicycle Vision Based Path Following Control,” DSORL-ISR Technical Report, September 2002.
- [151] **R. Oliveira**, “Mission Control for Autonomous Vehicles,” DSORL-ISR Technical Report, September 2002.
- [152] **D. Soetanto, L. Lapierre, and A. Pascoal**. “Path Following Control of a Nonholonomic Dynamic Wheeled Robot with Parametric Modeling Uncertainties,” DSORL-ISR Technical Report, September 2002.
- [153] **G. Libório, N. Paulino, R. Cunha, C. Silvestre, M. I. Ribeiro**, “Terrain following preview controller for model-scale helicopters,” DSORL/Mobile Robotics Labs-ISR Technical Report, September 2002.
- [154] **L. Wong**, “Marine Craft Control using Image and 3D Shape Matching,” DSORL-ISR Technical Report, September 2002.
- [155] **P. Oliveira and A. Pascoal**. “On the Design of Multirate Complementary Filters for Marine Vehicle Navigation: New Tools using Linear Matrix Inequalities (LMIs),” DSORL-ISR Technical Report, July 2002.
- [156] **R. Cunha, C. Silvestre, and A. Pascoal**, “A Path Following Controller for Model-Scale Helicopters,” DSORL-ISR Technical Report, July 2002.
- [157] **D. Soetanto, L. Lapierre, and A. Pascoal**, “Adaptive, Nonsingular Path Following Control of Dynamic Wheeled Robots,” DSORL-ISR Technical Report, July 2002.
- [158] **J. Alves, P. Oliveira, R. Oliveira, A. Pascoal, M. Rufino, L. Sebastião, and C. Silvestre**, “Vehicle and Mission Control of the DELFIM Autonomous Surface Craft,” DSORL-ISR Technical Report, July 2002.
- [159] **P. Alves**, “2D Target Tracking and Prediction,” DSORL-ISR Technical Report, July 2002.
- [160] **S. Remyantsev, A. Miroshnikov, A. Pascoal, E. Popova**, “A Loop Shaping Approach Based on Approximations to H_∞ -solutions with Applications to Design of Ship Course Keeping PID Controllers,” DSORL-ISR Technical Report, March 2002.
- [161] **S. Remyantsev, A. Pascoal, C. Silvestre**, “Acceleration Feedback for the Control of Marine Craft,” DSORL-ISR Technical Report, April 2002.
- [162] **Sandra Clara Gadanho, Luis Custódio**, Learning behavior-selection in a multi-goal robot task. Technical Report RT-701-02, Instituto de Sistemas e Robótica, IST
- [163] **Dejan Milutinovic**, Michael Athans, **Pedro Lima**, Jorge Carneiro, Application of Nonlinear Estimation Theory in TCR Triggering Model Identification, Technical Report RT-401-02, Instituto de Sistemas e Robótica

3.12 SUBMITTED PAPPERS

J) Ph.D. THESES (2):

- [164] **João M. Sanches**, Reconstrução 3D Bayesiana a Partir de Sequências Ecográficas, Ph. D. Thesis, IST, submitted, Sept. 2002
- [165] **Jacinto Nascimento**, Robust Shape Estimation and Tracking in the Presence of Clutter, Ph. D. Thesis, IST, submitted, Oct. 2002

K) CHAPTER OF BOOKS (2)

- [166] **Agostinho C da Rosa, Dalva Poyares, Christian Guilleminault**. Processamento de Sinais Electrofisiológicos para Detecção e Classificação Automática do Sono. In "Manual de Poligrafia do Sono". Edição da Associação Brasileira de Sono.
- [167] **Paulo M. Oliveira, V. Barroso**. Uncertainty in Time-Frequency Analysis. Invited article in chapter on Time-Frequency Signal and System Analysis, Time-Frequency Signal Analysis and Processing, Part II: Fundamental Principles of TFSAP, Ed. B. Boashash, Prentice-Hall, to appear 2003.

L) INTERNATIONAL JOURNALS (20)

- [168] **Márcia Maçãs, Luis Custódio**, Multiple Emotion-based Agents using an Extension of DARE Architecture, submitted to the Informatica Journal, Special Issue on Perception and Emotions Based Reasoning (under revision).
- [169] **Bruno Damas, Luis Custódio**, Emotion-based Decision and Learning Using Associative Memory and Statistical Estimation, submitted to the Informatica Journal, Special Issue on Perception and Emotions Based Reasoning (under revision).
- [170] **Rodrigo Ventura, Carlos Pinto-Ferreira**, An Indexing Mechanism For An Emotion-Based Agent, submitted to the Informatica Journal, Special Issue on Perception and Emotions Based Reasoning (under revision).
- [171] **Sandra Gadanho, Luis Custódio**, Learning behavior-selection in a multi-goal robot task, submitted to the Informatica Journal, Special Issue on Perception and Emotions Based Reasoning (under revision).
- [172] **Paulo Tabuada, George J. Pappas, Pedro Lima**, Compositional Abstractions of Hybrid Control Systems, submitted to Journal of Discrete Event Dynamical Systems (under revision).
- [173] **Paulo Tabuada, George J. Pappas, Pedro Lima**, Feasible Formations of Multi-Agent Systems, submitted to Automatica (under revision).
- [174] **D Poyares, C Guilleminault, AC Rosa**. "Autonomic Nervous System Indices in Upper Airway Resistance and mild Obstructive Sleep Apnea Syndromes". Am J Resp Critical Care Med.
- [175] **A Grilo, A Caetano, A Rosa**. "Artificial Immune System Simulation by Adaptive Complex System". Journal of EC and AL.
- [176] **C Munteanu, AC Rosa**. Adaptive Reservoir Evolutionary Algorithm: An evolutionary on-line adaptation scheme for global function optimization. IEEE – Trans. EC
- [177] **Tito Silva, Agostinho Rosa**. "Features Network: A new model for Object Representation". (33 pg) PAMI 2002

- [178] **Tito Silva, Agostinho Rosa.** "Conceptual Cortex: A Model for Higher Visual Cortex Areas". (26 pg) IEEE – Trans on NN, CE360.
- [179] **C Munteanu, AC Rosa.** Gray-Scale Image Enhancement as an Automatic Process driven by Evolution: IEEE – Trans. SMC-B
- [180] **João Xavier, Victor Barroso, and Paulo Lopes.** Blind Source Separation and Channel Identification: Exploiting 2nd-Order Statistics in Bayesian Frameworks. Invited submission for the June 2003 special issue of the Journal of the Brazilian Telecommunications Society, as an extended version of the communication with the same title presented at the International Telecommunications Symposium, ITS2002, Natal, Brazil, September 2002.
- [181] **Pedro M. Q. Aguiar and José M. F. Moura.** Rank 1 Weighted Factorization for 3D Structure Recovery: Algorithms and Performance Analysis. To appear. IEEE Transactions on Pattern Analysis and Machine Intelligence, 2003.
- [182] **José Moreira, Carlos Bispo,** Distributed Scheduling with Active Idleness: a key to the stabilization of multi class queuing networks, Submitted to the IEEE Trans. Aut. Control, October 2002.
- [183] **Luis Braga Campos , J. Azinheira,** "On the application of special functions to non-linear and unsteady stability, Part I: Method of interactive solution of coupled non-linear system", *Integral Transforms and Special Functions*, Volume 13 (to appear).
- [184] **Luis Braga Campos , J. Azinheira,** "On the application of special functions to non-linear and unsteady stability, Part II: Solution in term of Bessel and hypergeometric functions". *Integral Transforms and Special Functions*, Volume 13 (to appear).
- [185] **Luis Braga Campos, R. Saldanha , N. Isaeva** "On three-dimensional magnetosonic waves in an isothermal atmosphere under an horizontal magnetic field", *Journal of Plasma Physics* (to appear).
- [186] **Luis Braga Campos , P. Serrão,** "On helicoidal rectangular coordinates for the acoustics of bent and twisted tubes", *Wave Motion*, (to appear).
- [187] **Luis Braga Campos , N. Isaeva,** "On Alfvén waves in the solar breeze", *Physics of Plasmas*, (to appear).

M) INTERNATIONAL CONFERENCES (7)

- [188] **João Sequeira, M. Isabel Ribeiro,** "A Geometric Approach to Single and Multiple Robot Control" accepted for presentation on the IFAC Symposium on Robot Control, SYROCO 2003, September 2003, Wroclaw, Poland.
- [189] **Pedro Lima, Luis Custódio, M. Isabel Ribeiro, José Santos-Victor,** "The RESCUE Project: Cooperative Navigation for Rescue Robots", Proceedings do 1st International Workshop on Advances in Service Robotics, ASER'03, Bardolino, Italy, March 2003.
- [190] **T. Patrão, J. Xavier, V. Barroso.** Blind Symbol Detection and Channel Acquisition in Fast-Fading Wireless Systems with Space Diversity. To appear, IEEE International Conference on Acoustics, Speech and Signal Processing, ICASSP 2003, Hong Kong, to appear April 2003.
- [191] **P. Lopes, J. Xavier, V. Barroso.** Exploiting 2nd-Order Statistics in Bayesian Signal Reconstruction Problems. To appear, IEEE International Conference on Acoustics, Speech and Signal Processing, ICASSP 2003, Hong Kong, to appear April 2003.
- [192] **J.P. Gomes, V. Barroso.** Doppler Compensation in Underwater Channels Using Time-Reversal Array. To appear, IEEE International Conference on Acoustics, Speech and Signal Processing, ICASSP 2003, Hong Kong, to appear April 2003.

- [193] **T. Patrão, J. Xavier, V. Barroso.** An Interior Point Method for Joint Symbol Detection and Multichannel Acquisition in Fast-Fading Narrowband Channels. IEEE International Workshop on Signal Processing Advances for Wireless Communications, SPAWC 2003, Roma, Itália, to appear June 2003.
- [194] **Rui F. C. Guerreiro and Pedro M. Q. Aguiar.** Estimation of Rank Deficient Matrices from Partial Observations: Two-Step Iterative Algorithms. To appear. Energy Minimization Methods in Computer Vision and Pattern Recognition, Lisboa, Portugal, 2003.

N) IN NATIONAL CONFERENCES (4) :

- [195] **Paulo M. Oliveira, Victor A. N. Barroso,** "Numerical Differentiation of Discrete-Time Sequences," submitted to IV Conferência em Telecomunicações, CONFTELE 2003, Aveiro, Portugal, 2003.
- [196] **João P. Gomes, Victor A. N. Barroso,** "QR-RLS Adaptation of Modular Multichannel Lattice Filters," submitted to IV Conferência em Telecomunicações, CONFTELE 2003, Aveiro, Portugal, 2003.
- [197] **Miloud Frikel, Victor A. N. Barroso,** "Mobile Positioning: Angle of Arrival Estimation," submitted to IV Conferência em Telecomunicações, CONFTELE 2003, Aveiro, Portugal, 2003.
- [198] **Sebastien Bausson, Victor A. N. Barroso,** "Estimation of a Rank-One Signal Subspace in Small Sample Regime," submitted to IV Conferência em Telecomunicações, CONFTELE 2003, Aveiro, Portugal, 2003.

4.0 LABORATORY FACILITIES AND SERVICES

4.1 COMMON FACILITIES

ISR/IST has a computer network infra-structure based on 2 DEC Alpha servers and 7 DEC Alpha workstations. The Computing Center group runs also three Macintosh computers and 4 laser printers. More than 200 users have accounts on the isr.ist.utl.pt domain, and more than 100 machines, including PCs, SUN workstations, Macintoshes and others, are currently linked to the network.

4.2 LABORATORY FACILITIES

INTELLIGENT SYSTEMS Lab (IS)

The ISLab offers the main following facilities:

1 RWI ATRV-Jr mobile robot, 4-wheel drive, equipped with 16 sonars, GPS, inertial navigation module and a compass, pan and tilt vision system and one SICK Laser scanner (shared with the Mobile Robotics and Computer and Robot Vision Labs).

1 Blimp aerial robot, with pan and tilt vision system, 3 servomotors, RF link for remote control and remote video-link for video transmission

4 Nomadic Super-Scout II mobile robots, equipped with 16 sonars and 2 cameras each, one of them part of an omnidirectional catadioptric system.

14 Philips 740K USB Web Cams, used in the soccer robots

9 WaveLan Wireless Ethernet PCMCIA boards.

1 Mobile Platform, built at ISR, with tricycle-like kinematics, 60W and 90W motors, open control and guidance architecture based on 2 Pentium motherboards, and 2 on-board cameras.

1 Mobile Platform, built at ISR, with differential drive kinematics, 2*360W motors, open control and guidance architecture based on ai80486 motherboard.

1 Real-Time RF video link.

Matlab and Simulink software for different simulation projects.

Several cameras, used for visual servoing and vision-based navigation applied to manipulators and mobile robots.

1 Space Mouse device, for teleoperation of mobile robots and manipulators.

1 PUMA 560 manipulator, whose Mark III controller was partially replaced by Trident Robotics TRC 004/6 boards, which allow manipulator control by an external PC.

25 Pentium Personal Computers (including 5 laptops) – under Linux and Windows 98/2000/XP OS.

MOBILE ROBOTICS Lab (LRM)

The LRM offers the main following facilities:

- Robuter mobile platform, with a ring of 24 ultrasound sensors, and two on-boards processors: Motorola 68020@16MHz running the real-time operating system Albatros, and a Pentium@200Mhz running Windows NT. A laser scanner (Lasernet system) for localisation purposes with artificial landmarks is installed on the platform.
- 2 Scout mobile platforms with on-board computer, vision camera and wireless Ethernet
- 1 ATRV Jr Rover with ultrasound sensors, GPS and Inertial Measurement Unit. This mobile platform is shared with the Intelligent Control and Computer Vision Laboratories.
- A 6 dof robot arm (GT 6A Robotique) installed on top the Robuter mobile platform.
- 3 Mb/s wireless ethernet systems with two Access Points supporting roaming operation.
- 6 complete sets of the LEGO system for Mobile Robotics
- A Laser Range Finder from the Riegl supplier with range and luminance measurement.
- 2 Sick Laser Scanner.
- Three computer controlled Pan & Tilt Units from Direct Perception.
- Video cameras, including two Quick Cams and a Network Eye supporting direct display of real scenes on the Internet.
- 10 Pentium PCs + 5 portable Pentiums. Four more PCs are available from external partners.
- Two laser printers, and one DeskJet colour printer.
- A large open space appropriate for mobile robotics navigation experiments.

COMPUTER VISION Lab (VISLAB)

The VisLab is equipped with various PCs , a DEC-Alpha Workstation, various cameras (CCD, CMOS, Colour, Black & White, Digital or Analogue) and image frame grabbers, a pan-tilt unit and several pan-tilt cameras.

Special equipment consists of a high-speed 4 degrees of freedom binocular head – Medusa - developed for research in active vision, a TRC LabMate mobile platform, two Nomad Superscout mobile platforms, equipped with vision and an on-board computer. Additionally various home-made small robots have been developed and are used for experiments in the areas of vision based control.

More recently a smaller active vision head was built and installed on a mobile vehicle for experiments in vision based navigation with extra degrees of freedom.

SIGNAL PROCESSING Lab (SP) - LISBON

The SP Lab offers capabilities to develop and test both software and hardware products for digital signal processing. Presently, the activities in course include the design and implementation of modems for underwater acoustic data communications, the development of very low bit rate video compression algorithms for underwater acoustic transmission, and testing of navigation and guidance techniques for autonomous robotics.

- 3 Intel 486 personal computers
- 3 Intel Pentium personal computers
- 1 NeXT workstation
- 1 Hewlett-Packard LaserJet 4M printer
- 1 Hewlett-Packard OfficeJet Pro 1150C color inkjet printer/scanner
- 10 Mbit/s thin Ethernet LAN interfacing the Signal Processing Laboratory to the ISR Network
- 4 processor DEC2100 Alpha server and 10 workstations of various types including DEC Alphas, HP's and SGI's. It also has several PC's, b/w laser and wax colour printers.
- 1 Mini robot platform KHEPERA
- 1 ORCA underwater acoustic communication system
 - 1 surface modem
 - 1 programmable acoustic receiver
 - 1 underwater modem
- 1 Motorola software development system for the DSP56000 digital signal processor (DSP)
- 1 Motorola DSP96002 hardware/software DSP development system
- 2 Analog Devices SHARC ADSP21061 hardware/software DSP development systems
- 1 Xilinx field programmable gate array (FPGA) hardware/software development system
- 1 National Instruments PCI-MIO-16E-4 multifunction data acquisition board and LabView virtual instrumentation software
- 1 Matrox Rainbow Runner video capture board
- 1 TEAC CS-391 multichannel data recorder
- 1 Sony TCD-D3 portable digital audio tape (DAT) stereo recorder
- 1 Goldstar OS-9040D 40 MHz analog oscilloscope
- 1 Hewlett-Packard HP8116A 50 Mhz function generator
- 1 Escort EGC 3230 2 Mhz function generator with 100 Mhz frequency meter
- 1 Sony F670ES power amplifier
- 1 Kiotto KT-1990EX digital multimeter

- 1 GW ST3030TD triple power supply
- 1 Weller WTCP-S soldering station

SIGNAL PROCESSING Lab (SP) - ALGARVE

- 1 room with 7 research desks + electronics testing bench internal 100/1000 Mb computer network w/router, NFS, printers, automatic backups, RAID5, etc...
- 1 vertical line array (16 hyd) + radio buoy + acquisition system
- 1 remote buoy w/ wireless lan
- 1 260-900 Hz high power acoustic sound source (tomography)

DYNAMICAL SYSTEMS AND OCEAN ROBOTICS LAB (DSOR)

Vehicles

- **DELFIN Autonomous Surface Vehicle (ASC)** - an autonomous surface craft (Catamaran-type) to carry out experimental research in the area of ocean robotics and to perform scientific missions at sea.
- **INFANTE Autonomous Underwater Vehicle (AUV)** - an autonomous underwater vehicle to carry out experimental research in the area of ocean robotics and to perform scientific missions at sea.
- **R/C Helicopter VARIO XTREM** - a small helicopter (payload of 4 Kg) to carry out experimental research in the area of autonomous aerial robotics.
- Small **Zodiac** to support operations at sea.

Mechanical/ Electrical Equipment

- **Pressure Chamber** - to test the marinization of equipment down to depths of 600 meters.
- **Mechanical / Electric shop** (8th Floor of ISR) - basic equipment and tools to machine pieces and to assemble circuit boards.
- **Crane** with the capacity of 2500 Kg.
- **Industrial air compressor.**

Actuators and Sensors for Robotic Ocean Vehicle Development and Operation (part of the equipment is dedicated to the operation of the INFANTE AUV)

- *Actuators* - 5 electrical thrusters.
- 3 rate gyros, 2 pendulums and 1 fluxgate (Watson's Attitude & Heading Reference Unit AHRS-C303);
- 3 rate gyros, 3 accelerometers and 1 magnetometer (SEATEX MRU-6)
- 3 rate gyros, 2 pendulums and 1 magnetometer (KVH attitude reference unit).
- 1 flowmeter TSA-06-C-A (EG & G Flow Technology);
- 2 depth cells DC 10R-C (Transinstruments);
- 2 echosounders ST200 (Tritech);
- 2 echosounders ST500 (Tritech);
- GIB (GPS Intelligent Buoys) – GPS based underwater positioning system, with target tracking capabilities.
- 1 Doppler Log TSM 5740 with 4 beams in a Janus configuration, operating at 300 KHz (Thomson-ASM);
- one set of 3 rate gyros, 2 pendulums and 1 directional gyro from Humphreys.
- 1 *Long Baseline Positioning System* for underwater vehicle positioning - 1 transducer and 4 transponders.

- 1 DGPS (*Differential Global Positioning System*) for accurate surface vehicle navigation - 4 Motorola Encore unit and 3 FREEWAVE radios.

Hardware and Software Development Systems for Vehicle Simulation and Real-Time Vehicle Control.

- *Hardware for real-time applications* - 3 Gespac 68030/68882 computers; a T805 transputer array; 4 MPL stand-alone 68020/60881 computers.
- *3 Single Board Computers RTD/USA*
- *Development System* - Microware FASTRAK development software running on a SUN-Workstation; professional OS9 for Gespac development systems.

Software Tools for Navigation, Guidance, and Control System Design.

INTEGRA - Modeling and simulation tool for *the integrated analysis and design of navigation, guidance and control systems for autonomous vehicles*. The software was developed at IST/ISR and is built around the commercially available package MATLAB. The package is specially geared towards the development of dynamic models of robotic ocean vehicles. Furthermore, it provides the means to assess the combined performance of navigation, guidance and control systems prior to their implementation.

General Computer Facilities.

- 8 Desktop PCs
- 6 Laptop PCs
- 1 Macintosh
- 2 Laser printers

EVOLUTIONARY SYSTEMS AND BIOMEDICAL ENGINEERING Lab (LASEEB)

The Laseeb offers the main following facilities on digital signal processing for biomedical engineering, digitalization and development for multimedia Applications.

20 Personal Computers running Windows 98/NT4/2000 and Linux.

2 Laser printer,

2 color inkjet printers

1 Video Capture Board MIRO VIDEO DC30

3 Cd-RW Recorders

1 Tape Backup 12 Gb

1 Scanner

1 Biological amplifier Medelec

1 Biological amplifier Braintronics

1 Biological amplifier CAPS

2x30 ch. A/D Acquisition DT 2834 16 Hz

2x16 ch. A/D Acquisition DT 2821 150 Hz

1x16 ch. A/D Acquisition DT 2811 30 Khz

1x8 ch A/D Acquisition PCMCIA 50Khz

AERONAUTICS GROUP

- Flight test laboratory - Instrumentation packages for Alpha Jet, A7 and Aviocar, and calibration, and data processing equipment.
- Transfer of Flight Simulator from Delft University of Technology to IST.